

HD14043B, HD14044B

Quadruple R-S Latch

The HD14043B and HD14044B quad R-S latches have an independent Q output and set and reset inputs. The Q outputs are gated through three-state buffers having a common enable input. The outputs are enabled with a logical "1" or high on the enable input; a logical "0" or low disconnects the latch from the Q outputs, resulting in an open circuit at the Q outputs.

FEATURES

- Quiescent Current = 4 nA/pkg typ. @10V
- Double Diode Input Protection
- Three-State Outputs with Common Enable
- Outputs Capable of Driving One Low-power Schottky TTL Load Over the Rated Temperature Range
- Supply Voltage Range = 3 to 18V

LOGIC DIAGRAM

HD14043B

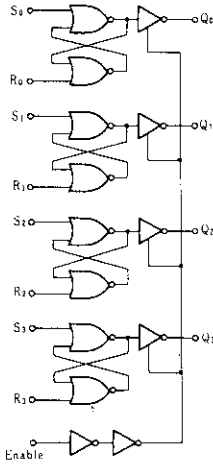

HD14044B

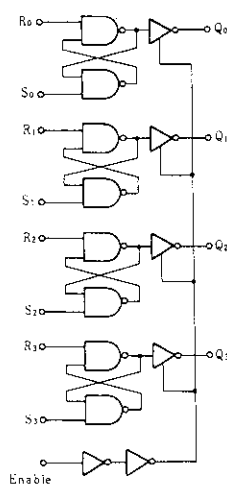

PIN ARRANGEMENT

HD14043B

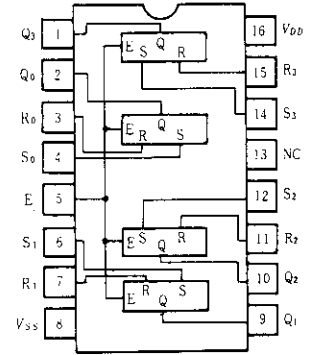

(Top View)

HD14044B

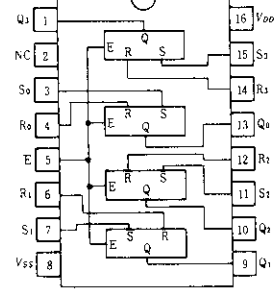

(Top View)

THREE-STATE ENABLE/DISABLE DELAYS

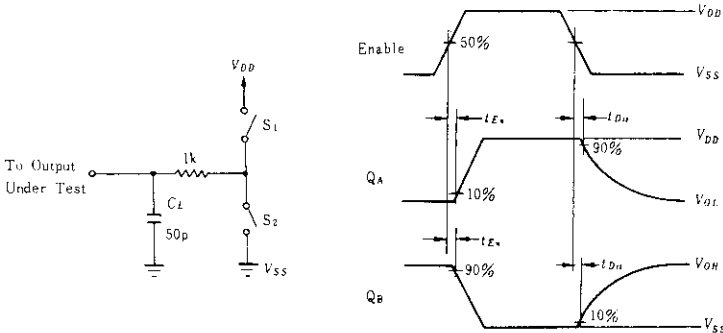

Testing Method

Test	S	R	HD14043B			HD14044B		
			S ₁	S ₂	Q	S ₁	S ₂	Q
t _{EN}	V _{DD}	V _{SS}	Open	Closed	A	Closed	Open	B
t _{EN}	V _{SS}	V _{DD}	Closed	Open	B	Open	Closed	A
t _{D10}	V _{DD}	V _{SS}	Open	Closed	A	Closed	Open	B
t _{D10}	V _{SS}	V _{DD}	Closed	Open	B	Open	Closed	A

TRUTH TABLE

HD14043B

S	R	E	Q
X	X	0	High Impedance
0	0	1	No Change
0	1	1	0
1	0	1	1
1	1	1	1

HD14044B

S	R	E	Q
X	X	0	High Impedance
0	0	1	0
0	1	1	1
1	0	1	0
1	1	1	No Change

x=Don't Care

ELECTRICAL CHARACTERISTICS

Characteristic	Symbol	$V_{DD}(V)$	Test Conditions	-40°C		25°C			85°C		Unit
				min	max	min	typ	max	min	max	
Output Voltage	V_{OL}	5.0	$V_{in}=V_{DD}$ or 0	-	0.05	-	0	0.05	-	0.05	V
		10		-	0.05	-	0	0.05	-	0.05	
		15		-	0.05	-	0	0.05	-	0.05	
	V_{OH}	5.0	$V_{in}=0$ or V_{DD}	4.95	-	4.95	5.0	-	4.95	-	V
		10		9.95	-	9.95	10	-	9.95	-	
		15		14.95	-	14.95	15	-	14.95	-	
Input Voltage	V_{IL}	5.0	$V_{out}=4.5$ or $0.5V$	-	1.5	-	2.25	1.5	-	1.5	V
		10	$V_{out}=9.0$ or $1.0V$	-	3.0	-	4.50	3.0	-	3.0	
		15	$V_{out}=13.5$ or $1.5V$	-	4.0	-	6.75	4.0	-	4.0	
	V_{IH}	5.0	$V_{out}=0.5$ or $4.5V$	3.5	-	3.5	2.75	-	3.5	-	V
		10	$V_{out}=1.0$ or $9.0V$	7.0	-	7.0	5.50	-	7.0	-	
		15	$V_{out}=1.5$ or $13.5V$	11.0	-	11.0	8.25	-	11.0	-	
Output Drive Current	I_{OH}	5.0	$V_{OH}=2.5V$	-2.5	-	-2.1	-4.2	-	-1.7	-	mA
		5.0	$V_{OH}=4.6V$	-0.52	-	-0.44	-0.88	-	-0.36	-	
		10	$V_{OH}=9.5V$	-1.3	-	-1.1	-2.25	-	-0.9	-	
		15	$V_{OH}=13.5V$	-3.6	-	-3.0	-8.8	-	-2.4	-	
	I_{OL}	5.0	$V_{OL}=0.4V$	0.52	-	0.44	0.88	-	0.36	-	mA
		10	$V_{OL}=0.5V$	1.3	-	1.1	2.25	-	0.9	-	
15		$V_{OL}=1.5V$	3.6	-	3.0	8.8	-	2.4	-		
Input Current	I_{in}	15		-	± 0.3	-	± 0.00001	± 0.3	-	± 1.0	μA
Input Capacitance	C_{in}	-	$V_{in}=0$	-	-	-	5.0	7.5	-	-	pF
Quiescent Current	I_{DD}	5.0	Zero Signal, per Package	-	4.0	-	0.002	4.0	-	30	μA
		10		-	8.0	-	0.004	8.0	-	60	
		15		-	16	-	0.006	16	-	120	
Total Supply Current*	I_T	5.0	Dynamic+ I_{DD} , per Gate	-	-	-	0.58	-	-	-	μA
		10		-	-	-	1.15	-	-	-	
		15	$C_L=50pF$, $f=1kHz$	-	-	-	1.73	-	-	-	
Three-State Output Leakage Current	I_{7L}	15		-	± 1.0	-	± 0.00001	± 1.0	-	± 7.5	μA

* To calculate total supply current at frequency other than 1kHz.

@ $V_{DD}=5.0V$ $I_T=(0.58\mu A/kHz)f+I_{DD}$, @ $V_{DD}=10V$ $I_T=(1.15\mu A/kHz)f+I_{DD}$, @ $V_{DD}=15V$ $I_T=(1.73\mu A/kHz)f+I_{DD}$

■ SWITCHING CHARACTERISTICS ($C_L=50\text{pF}$, $T_a=25^\circ\text{C}$)

Characteristic	Symbol	V_{DD} (V)	min	typ	max	Unit
Output Rise Time	t_r	5.0	—	100	200	ns
		10	—	50	100	
		15	—	40	80	
Output Fall Time	t_f	5.0	—	100	200	ns
		10	—	50	100	
		15	—	40	80	
Propagation Delay Time	t_{PLH}	5.0	—	175	350	ns
		10	—	75	175	
		15	—	60	120	
	t_{PHL}	5.0	—	175	350	ns
		10	—	75	175	
		15	—	60	120	
Set Pulse Width	PW_S	5.0	200	80	—	ns
		10	100	40	—	
		15	70	30	—	
Reset Pulse Width	PW_R	5.0	200	80	—	ns
		10	100	40	—	
		15	70	30	—	
Three-state Enable/Disable Delay	t_{E*}	5.0	—	150	300	ns
	t_{D*}	10	—	80	160	
		15	—	55	110	

■ DYNAMIC SIGNAL WAVEFORMS

● HD14043B

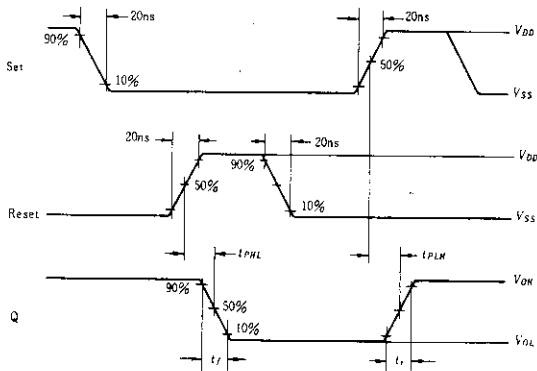

● HD14044B

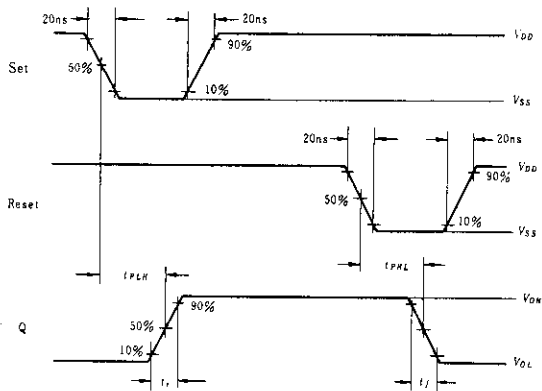



Hitachi Code	DP-16
JEDEC	Conforms
EIAJ	Conforms
Weight (reference value)	1.07 g

Cautions

1. Hitachi neither warrants nor grants licenses of any rights of Hitachi's or any third party's patent, copyright, trademark, or other intellectual property rights for information contained in this document. Hitachi bears no responsibility for problems that may arise with third party's rights, including intellectual property rights, in connection with use of the information contained in this document.
2. Products and product specifications may be subject to change without notice. Confirm that you have received the latest product standards or specifications before final design, purchase or use.
3. Hitachi makes every attempt to ensure that its products are of high quality and reliability. However, contact Hitachi's sales office before using the product in an application that demands especially high quality and reliability or where its failure or malfunction may directly threaten human life or cause risk of bodily injury, such as aerospace, aeronautics, nuclear power, combustion control, transportation, traffic, safety equipment or medical equipment for life support.
4. Design your application so that the product is used within the ranges guaranteed by Hitachi particularly for maximum rating, operating supply voltage range, heat radiation characteristics, installation conditions and other characteristics. Hitachi bears no responsibility for failure or damage when used beyond the guaranteed ranges. Even within the guaranteed ranges, consider normally foreseeable failure rates or failure modes in semiconductor devices and employ systemic measures such as fail-safes, so that the equipment incorporating Hitachi product does not cause bodily injury, fire or other consequential damage due to operation of the Hitachi product.
5. This product is not designed to be radiation resistant.
6. No one is permitted to reproduce or duplicate, in any form, the whole or part of this document without written approval from Hitachi.
7. Contact Hitachi's sales office for any questions regarding this document or Hitachi semiconductor products.

HITACHI

Hitachi, Ltd.

Semiconductor & Integrated Circuits.
Nippon Bldg., 2-6-2, Ohte-machi, Chiyoda-ku, Tokyo 100-0004, Japan
Tel: Tokyo (03) 3270-2111 Fax: (03) 3270-5109

URL North America : <http://semiconductor.hitachi.com/>
 Europe : <http://www.hitachi-eu.com/hel/ecg>
 Asia (Singapore) : <http://www.has.hitachi.com.sg/grp3/sicd/index.htm>
 Asia (Taiwan) : http://www.hitachi.com.tw/E/Product/SICD_Frame.htm
 Asia (HongKong) : <http://www.hitachi.com.hk/eng/bo/grp3/index.htm>
 Japan : <http://www.hitachi.co.jp/Sicd/indx.htm>

For further information write to:

Hitachi Semiconductor
(America) Inc.
179 East Tasman Drive,
San Jose, CA 95134
Tel: <1> (408) 433-1990
Fax: <1>(408) 433-0223

Hitachi Europe GmbH
Electronic components Group
Dornacher Straße 3
D-85622 Feldkirchen, Munich
Germany
Tel: <49> (89) 9 9180-0
Fax: <49> (89) 9 29 30 00

Hitachi Europe Ltd.
Electronic Components Group.
Whitebrook Park
Lower Cookham Road
Maidenhead
Berkshire SL6 8YA, United Kingdom
Tel: <44> (1628) 585000
Fax: <44> (1628) 778322

Hitachi Asia Pte. Ltd.
16 Collyer Quay #20-00
Hitachi Tower
Singapore 049318
Tel: 535-2100
Fax: 535-1533

Hitachi Asia Ltd.
Taipei Branch Office
3F, Hung Kuo Building, No.167,
Tun-Hwa North Road, Taipei (105)
Tel: <886> (2) 2718-3666
Fax: <886> (2) 2718-8180

Hitachi Asia (Hong Kong) Ltd.
Group III (Electronic Components)
7/F., North Tower, World Finance Centre,
Harbour City, Canton Road, Tsim Sha Tsui,
Kowloon, Hong Kong
Tel: <852> (2) 735 9218
Fax: <852> (2) 730 0281
Telex: 40815 HITEC HX

Copyright ' Hitachi, Ltd., 1999. All rights reserved. Printed in Japan.

HITACHI