

# M5278LXX, M5278LXXM

**(5V, 5.6V, 8V, 9V, 10V, 12V, 15V) 3-TERMINAL FIXED POSITIVE OUTPUT VOLTAGE REGULATOR (WITH FOLD-BACK PROTECTION CIRCUIT)**

## DESCRIPTION

The M5278L series consists of monolithic integrated circuits, each a three-terminal regulator with maximum load capabilities of 100mA and featuring output voltages of 5, 5.6, 8, 9, 10, 12, or 15V. The high-performance, fixed-positive output power supply ICs are packaged in 3-pin packages featuring fold-back protective circuits for limiting current when load short. They are especially appropriate for use in personal computers and general power supplies of electrical appliances.

## FEATURES

- Interchangeable with other brand 78L series  
.....  $I_{Lmax}=100mA$
- Internal fold-back protection circuit limits current due to shorted loads.  
M5278L05 ..... 16.5mA(typ.) (1/10 that of other brands)
- High ripple division factor  
M5278L05 ..... 73dB(typ.)
- Low output voltage tolerancee .....  $\pm 5\%$ (max.)
- High level of permissible internal heat dissipation  
..... 900mW(max.) 3P5  
..... 500mW(max.) 3P2

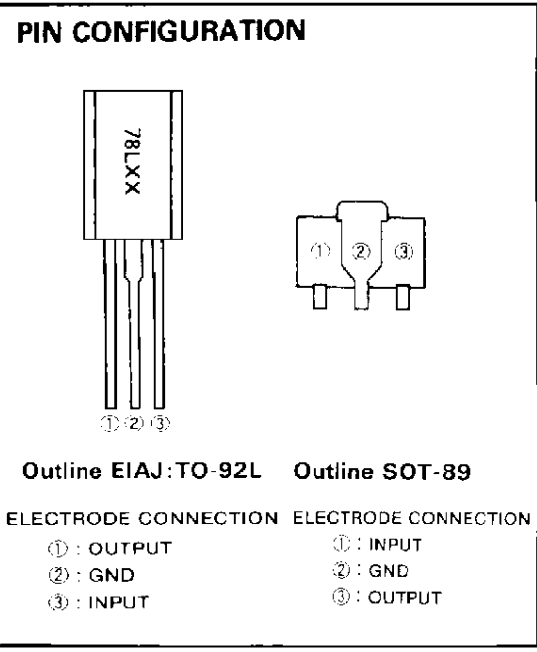

## APPLICATION

Power supply for microcomputer in VTR equipment, general power supply for electronic equipment of tape decks, car stereo equipment and radio cassette recorder.

M5278LXX (blank) 3P5 pkg.  
M..... 3P2 pkg.  
OUTPUT VOLTAGE VALUE

Type	Marking		Output voltage
	3P5	3P2	
M5278L05	78L05	MA	5V
M5278L56	78L56	MB	5.6V
M5278L10	78L10	MF	10V
M5278L12	78L12	MG	12V

Type	Marking		Output voltage
	3P5	3P2	
M5278L08	78L08	MD	8V
M5278L09	78L09	ME	9V
M5278L15	78L15	MH	15V

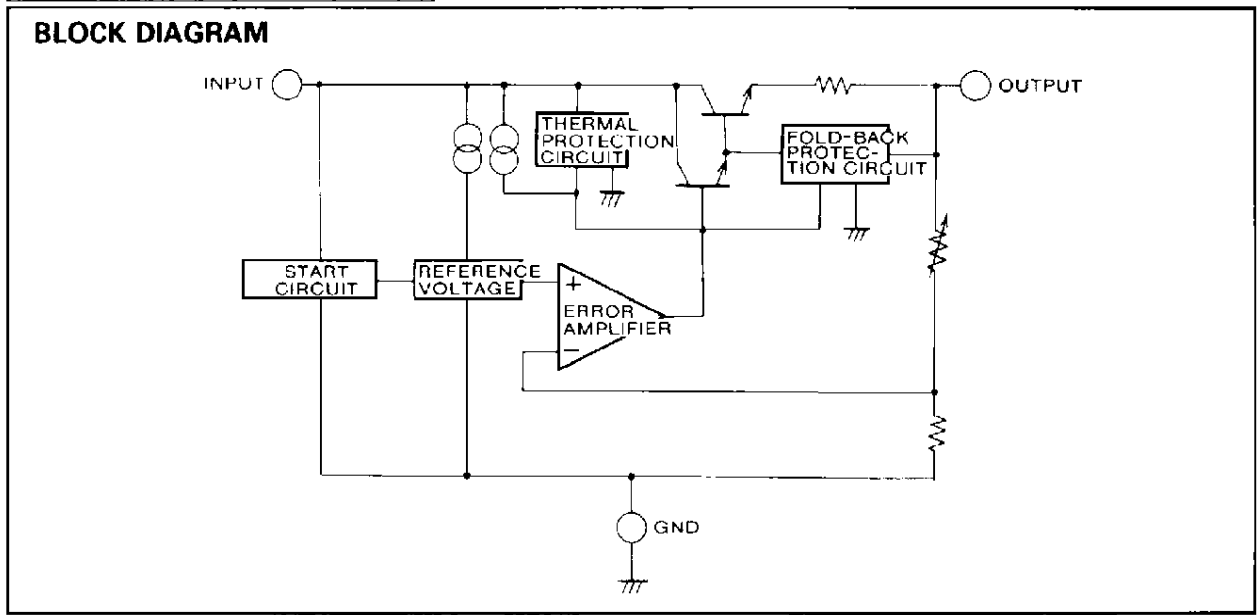

MITSUBISHI <LINEAR ICs>  
**M5278LXX, M5278LXXM**

**(5V, 5.6V, 8V, 9V, 10V, 12V, 15V) 3-TERMINAL FIXED POSITIVE  
 OUTPUT VOLTAGE REGULATOR (WITH FOLD-BACK PROTECTION CIRCUIT)**

**ABSOLUTE MAXIMUM RATINGS** ( $T_a=25^\circ\text{C}$ )

Symbol	Parameter	Ratings	Unit
$V_i$	Input voltage	36	V
$I_L$	Load current	100	mA
$P_d$	Power dissipation	900(3P5)/500(3P2)	mW
$T_{opr}$	Operating temperature	-20~+75	$^\circ\text{C}$
$T_{stg}$	Storage temperature	-55~+150	$^\circ\text{C}$

**STANDARD CONNECTION**

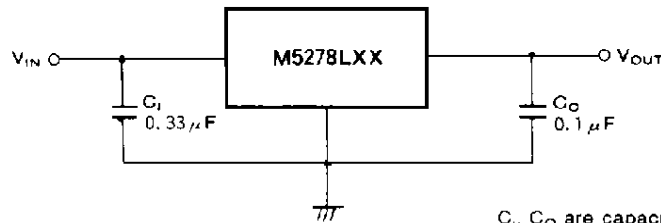

$C_i$ ,  $C_o$  are capacitors to prevent oscillation.  
 Make connections as close to the IC as possible

**ELECTRICAL CHARACTERISTICS**

**M5278L05** ( $V_i=10\text{V}$ ,  $I_L=40\text{mA}$ ,  $T_a=25^\circ\text{C}$ ,  $C_i=0.33\mu\text{F}$ ,  $C_o=0.1\mu\text{F}$ , unless otherwise noted)

Symbol	Parameter	Test conditions	Limits			Unit
			Min	Typ	Max	
$V_o$	Output voltage		4.75	5.0	5.25	V
$R_{reg-in}$	Input regulation	$7.5\text{V} \leq V_i \leq 20\text{V}$		50	200	mV
		$8\text{V} \leq V_i \leq 20\text{V}$		30	150	
$R_{reg-L}$	Load regulation	$1\text{mA} \leq I_L \leq 100\text{mA}$		10	60	mV
		$1\text{mA} \leq I_L \leq 40\text{mA}$		5	30	
$V_o$	Output voltage	$7.5\text{V} \leq V_i \leq 20\text{V}$ , $1\text{mA} \leq I_L \leq 40\text{mA}$	4.7	5.0	5.3	V
		$V_i=10\text{V}$ , $1\text{mA} \leq I_L \leq 70\text{mA}$	4.7	5.0	5.3	
$I_B$	Bias current	$I_L=0$		4.8	6.7	mA
$\Delta I_B$	Bias current variability	$8\text{V} \leq V_i \leq 20\text{V}$ , $I_L=40\text{mA}$		0.1	1.5	mA
		$V_i=10\text{V}$ , $1\text{mA} \leq I_L \leq 40\text{mA}$			0.2	
$V_{NO}$	Output noise voltage	BW: 10Hz~100kHz		49		$\mu\text{V}_{rms}$
RR	Ripple rejection ratio	$f=120\text{Hz}$ , $V_{in}=0\text{dBm}$	63	73		dB
$V_i - V_o$	Minimum input-output voltage difference			2.0		V
$I_{LP}$	Peak load current			130		mA
$I_{OS}$	Output short holding current			16.5		mA
$TC_{V_o}$	Temperature coefficient of output voltage	$I_L=5\text{mA}$		-0.6		mV/ $^\circ\text{C}$

**M5278LXX, M5278LXXM****(5V, 5.6V, 8V, 9V, 10V, 12V, 15V) 3-TERMINAL FIXED POSITIVE  
OUTPUT VOLTAGE REGULATOR (WITH FOLD-BACK PROTECTION CIRCUIT)****M5278L56** ( $V_I=11V, I_L=40mA, T_a=25^\circ C, C_I=0.33\mu F, C_O=0.1\mu F$ , unless otherwise noted)

Symbol	Parameter	Test conditions	Limits			Unit
			Min	Typ	Max	
$V_O$	Output voltage		5.32	5.6	5.88	V
$R_{reg-in}$	Input regulation	$8.5V \leq V_I \leq 21V$		50	200	mV
		$9V \leq V_I \leq 21V$		30	150	
$R_{reg-L}$	Load regulation	$1mA \leq I_L \leq 100mA$		10	60	mV
		$1mA \leq I_L \leq 40mA$		5	30	
$V_O$	Output voltage	$8.5V \leq V_I \leq 21V, 1mA \leq I_L \leq 40mA$	5.27	5.6	5.93	V
		$V_I=11V, 1mA \leq I_L \leq 70mA$	5.27	5.6	5.93	
$I_B$	Bias current	$I_L=0$		4.8	6.7	mA
$\Delta I_B$	Bias current differential	$9V \leq V_I \leq 21V, I_L=40mA$		0.1	1.5	mA
		$V_I=11V, 1mA \leq I_L \leq 40mA$			0.2	
$V_{NO}$	Output noise voltage	BW: 10Hz~100kHz		55		$\mu V_{rms}$
RR	Ripple rejection ratio	$f=120Hz, V_{in}=0dBm$	63	73		dB
$V_I-V_O$	Minimum input-output voltage difference			2.0		V
$I_{LP}$	Peak load current			150		mA
$I_{OS}$	Output short circuit sustain current			16.5		mA
$TC_{VO}$	Temperature coefficient of output voltage	$I_L=5mA$		-0.65		mV/°C

**M5278L08** ( $V_I=14V, I_L=40mA, T_a=25^\circ C, C_I=0.33\mu F, C_O=0.1\mu F$ , unless otherwise noted)

Symbol	Parameter	Test conditions	Limits			Unit
			Min	Typ	Max	
$V_O$	Output voltage		7.6	8.0	8.4	V
$R_{reg-in}$	Input regulation	$10.5V \leq V_I \leq 23V$		60	200	mV
		$11V \leq V_I \leq 23V$		40	150	
$R_{reg-L}$	Load regulation	$1mA \leq I_L \leq 100mA$		10	80	mV
		$1mA \leq I_L \leq 40mA$		5	40	
$V_O$	Output voltage	$10.5V \leq V_I \leq 23V, 1mA \leq I_L \leq 40mA$	7.52	8.0	8.48	V
		$V_I=14V, 1mA \leq I_L \leq 70mA$	7.52	8.0	8.48	
$I_B$	Bias current	$I_L=0$		4.8	6.7	mA
$\Delta I_B$	Bias current differential	$10.5V \leq V_I \leq 23V, I_L=40mA$		0.1	1.5	mA
		$V_I=14V, 1mA \leq I_L \leq 40mA$			0.2	
$V_{NO}$	Output noise voltage	BW: 10Hz~100kHz		80		$\mu V_{rms}$
RR	Ripple rejection ratio	$f=120Hz, V_{in}=0dBm$		56		dB
$V_I-V_O$	Minimum input-output voltage difference			2.0		V
$I_{LP}$	Peak load current			150		mA
$I_{OS}$	Output short circuit sustain current			12.5		mA
$TC_{VO}$	Temperature coefficient of output voltage	$I_L=5mA$		-0.9		mV/°C

# M5278LXX, M5278LXXM

## (5V, 5.6V, 8V, 9V, 10V, 12V, 15V) 3-TERMINAL FIXED POSITIVE OUTPUT VOLTAGE REGULATOR (WITH FOLD-BACK PROTECTION CIRCUIT)

**M5278L09** ( $V_i=16V, I_L=40mA, T_a=25^{\circ}C, C_1=0.33\mu F, C_O=0.1\mu F$ , unless otherwise noted)

Symbol	Parameter	Test conditions	Limits			Unit
			Min	Typ	Max	
$V_O$	Output voltage		8.55	9.0	9.45	V
$R_{reg-in}$	Input regulation	$12V \leq V_i \leq 24V$		60	225	mV
		$13V \leq V_i \leq 24V$		40	170	
$R_{reg-L}$	Load regulation	$1mA \leq I_L \leq 100mA$		10	90	mV
		$1mA \leq I_L \leq 40mA$		5	40	
$V_O$	Output voltage	$12V \leq V_i \leq 24V, 1mA \leq I_L \leq 40mA$	8.46	9.0	9.54	V
		$V_i=16V, 1mA \leq I_L \leq 70mA$	8.46	9.0	9.54	
$I_B$	Bias current	$I_L=0$		4.8	6.7	mA
$\Delta I_B$	Bias current differential	$13V \leq V_i \leq 24V, I_L=40mA$		0.1	1.5	mA
		$V_i=16V, 1mA \leq I_L \leq 40mA$			0.2	
$V_{NO}$	Output noise voltage	BW: 10Hz~100kHz		90		$\mu V_{rms}$
RR	Ripple rejection ratio	$f=120Hz, V_{in}=0dBm$		60		dB
$V_i-V_O$	Minimum input-output voltage difference			2.0		V
$I_{LP}$	Peak load current			150		mA
$I_{OS}$	Output short circuit sustain current			12.5		mA
$TC_{VO}$	Temperature coefficient of output voltage	$I_L=5mA$		-0.65		mV/°C

**M5278L10** ( $V_i=17V, I_L=40mA, T_a=25^{\circ}C, C_1=0.33\mu F, C_O=0.1\mu F$ , unless otherwise noted)

Symbol	Parameter	Test conditions	Limits			Unit
			Min	Typ	Max	
$V_O$	Output voltage		9.5	10.0	10.5	V
$R_{reg-in}$	Input regulation	$12.5V \leq V_i \leq 25V$		70	230	mV
		$13V \leq V_i \leq 25V$		50	170	
$R_{reg-L}$	Load regulation	$1mA \leq I_L \leq 100mA$		10	90	mV
		$1mA \leq I_L \leq 40mA$		5	45	
$V_O$	Output voltage	$12.5V \leq V_i \leq 25V, 1mA \leq I_L \leq 40mA$	9.4	10.0	10.6	V
		$V_i=17V, 1mA \leq I_L \leq 70mA$	9.4	10.0	10.6	
$I_B$	Bias current	$I_L=0$		4.8	6.7	mA
$\Delta I_B$	Bias current differential	$13V \leq V_i \leq 25V, I_L=40mA$		0.1	1.5	mA
		$V_i=17V, 1mA \leq I_L \leq 40mA$			0.2	
$V_{NO}$	Output noise voltage	BW: 10Hz~100kHz		100		$\mu V_{rms}$
RR	Ripple rejection ratio	$f=120Hz, V_{in}=0dBm$	52	59		dB
$V_i-V_O$	Minimum input-output voltage difference			2.0		V
$I_{LP}$	Peak load current			130		mA
$I_{OS}$	Output short circuit sustain current			12.5		mA
$TC_{VO}$	Temperature coefficient of output voltage	$I_L=5mA$		-0.9		mV/°C

MITSUBISHI <LINEAR ICs>  
**M5278LXX, M5278LXXM**

**(5V, 5.6V, 8V, 9V, 10V, 12V, 15V) 3-TERMINAL FIXED POSITIVE  
OUTPUT VOLTAGE REGULATOR (WITH FOLD-BACK PROTECTION CIRCUIT)**

**M5278L12** ( $V_i=19V, I_L=40mA, T_a=25^\circ C, C_1=0.33\mu F, C_O=0.1\mu F$ , unless otherwise noted)

Symbol	Parameter	Test conditions	Limits			Unit
			Min	Typ	Max	
$V_O$	Output voltage		11.4	12.0	12.6	V
$R_{eg-in}$	Input regulation	$14.5V \leq V_i \leq 27V$		70	250	mV
		$16V \leq V_i \leq 27V$		50	200	
$R_{eg-L}$	Load regulation	$1mA \leq I_L \leq 100mA$		10	100	mV
		$1mA \leq I_L \leq 40mA$		5	50	
$V_O$	Output voltage	$14.5V \leq V_i \leq 27V, 1mA \leq I_L \leq 40mA$	11.3	12.0	12.7	V
		$V_i=19V, 1mA \leq I_L \leq 70mA$	11.3	12.0	12.7	
$I_B$	Bias current	$I_L=0$		4.8	6.7	mA
$\Delta I_B$	Bias current differential	$16V \leq V_i \leq 27V, I_L=40mA$		0.1	1.5	mA
		$V_i=19V, 1mA \leq I_L \leq 40mA$			0.2	
$V_{NO}$	Output noise voltage	BW: 10Hz~100kHz		110		$\mu V_{rms}$
RR	Ripple rejection ratio	$f=120Hz, V_{in}=0dBm$	50	56		dB
$V_i - V_O$	Minimum input-output voltage difference			2.0		V
$I_{LP}$	Peak load current			150		mA
$I_{OS}$	Output short circuit sustain current			12.5		mA
$TC_{VO}$	Temperature coefficient of output voltage	$I_L=5mA$		-1.0		mV/°C

**M5278L15** ( $V_i=23V, I_L=40mA, T_a=25^\circ C, C_1=0.33\mu F, C_O=0.1\mu F$ , unless otherwise noted)

Symbol	Parameter	Test conditions	Limits			Unit
			Min	Typ	Max	
$V_O$	Output voltage		14.25	15.0	15.75	V
$R_{eg-in}$	Input regulation	$17.5V \leq V_i \leq 30V$		80	300	mV
		$20V \leq V_i \leq 30V$		60	250	
$R_{eg-L}$	Load regulation	$1mA \leq I_L \leq 100mA$		10	150	mV
		$1mA \leq I_L \leq 40mA$		5	75	
$V_O$	Output voltage	$17.5V \leq V_i \leq 30V, 1mA \leq I_L \leq 40mA$	14.1	15.0	15.9	V
		$V_i=23V, 1mA \leq I_L \leq 70mA$	14.1	15.0	15.9	
$I_B$	Bias current	$I_L=0$		4.8	6.7	mA
$\Delta I_B$	Bias current differential	$23V \leq V_i \leq 30V, I_L=40mA$		0.1	1.5	mA
		$V_i=23V, 1mA \leq I_L \leq 40mA$			0.2	
$V_{NO}$	Output noise voltage	BW: 10Hz~100kHz		140		$\mu V_{rms}$
RR	Ripple rejection ratio	$f=120Hz, V_{in}=0dBm$	40	45		dB
$V_i - V_O$	Minimum input-output voltage difference			2.0		V
$I_{LP}$	Peak load current			150		mA
$I_{OS}$	Output short circuit sustain current			12.5		mA
$TC_{VO}$	Temperature coefficient of output voltage	$I_L=5mA$		-0.9		mV/°C

MITSUBISHI <LINEAR ICs>  
**M5278LXX, M5278LXXM**

**(5V, 5.6V, 8V, 9V, 10V, 12V, 15V) 3-TERMINAL FIXED POSITIVE  
 OUTPUT VOLTAGE REGULATOR (WITH FOLD-BACK PROTECTION CIRCUIT)**

**TYPICAL CHARACTERISTICS**

**THERMAL DERATING (MAXIMUM RATING)**

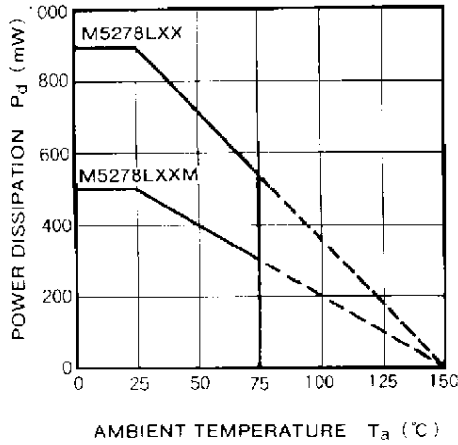

**BIAS CURRENT VS. INPUT VOLTAGE**

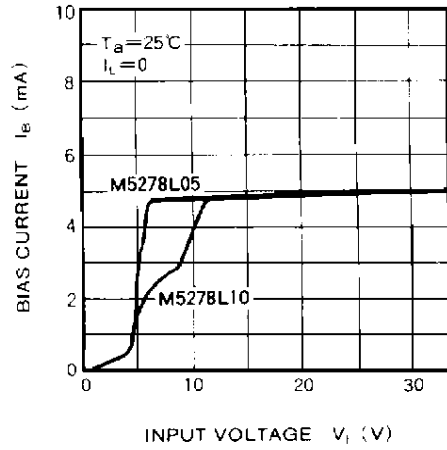

**BIAS CURRENT VS. INPUT VOLTAGE**

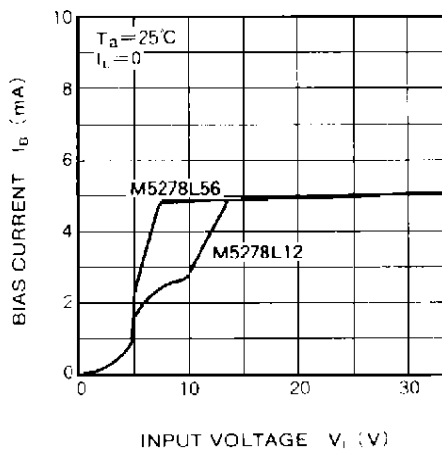

**OUTPUT VOLTAGE VS. INPUT VOLTAGE**

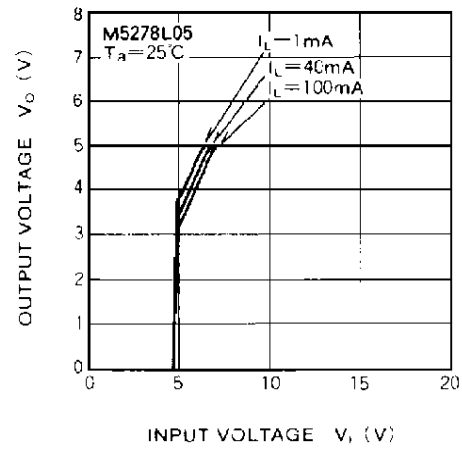

**OUTPUT VOLTAGE VS. INPUT VOLTAGE**

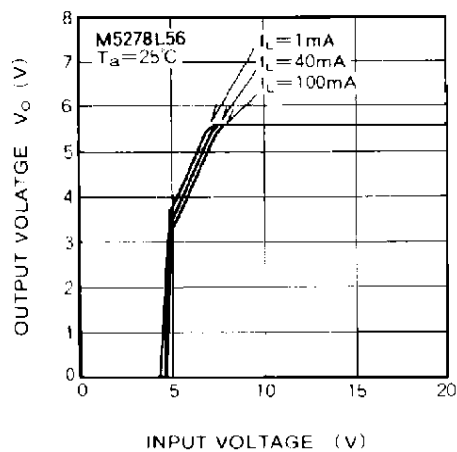

**OUTPUT VOLTAGE VS. INPUT VOLTAGE**

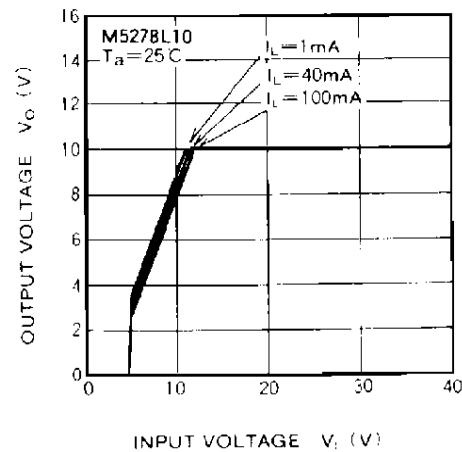

# M5278LXX, M5278LXXM

## (5V, 5.6V, 8V, 9V, 10V, 12V, 15V) 3-TERMINAL FIXED POSITIVE OUTPUT VOLTAGE REGULATOR (WITH FOLD-BACK PROTECTION CIRCUIT)

OUTPUT VOLTAGE VS. INPUT VOLTAGE

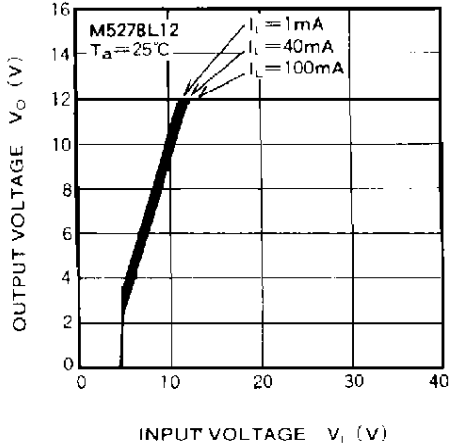

OUTPUT VOLTAGE VS. LOAD CURRENT

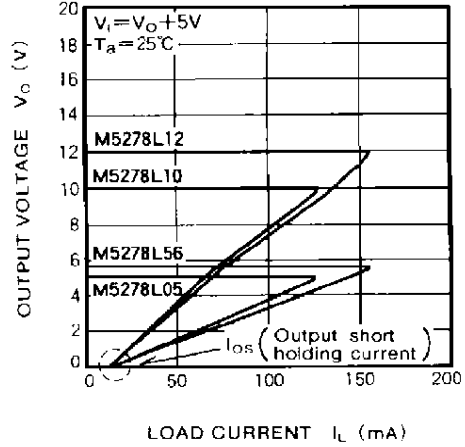

BIAS CURRENT VS. AMBIENT TEMPERATURE

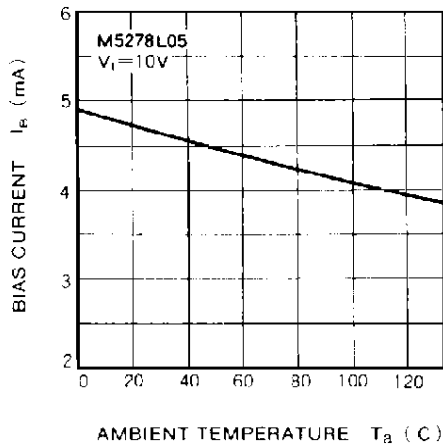

OUTPUT VOLTAGE VS. AMBIENT TEMPERATURE

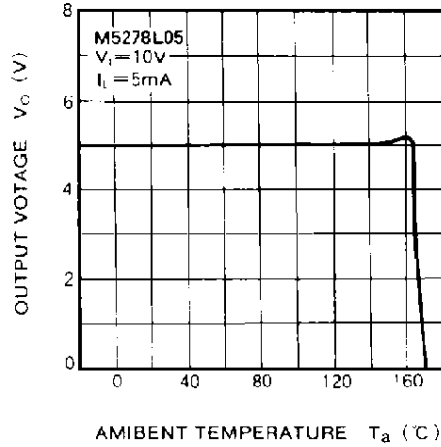

RIPPLE REJECTION VS. FREQUENCY

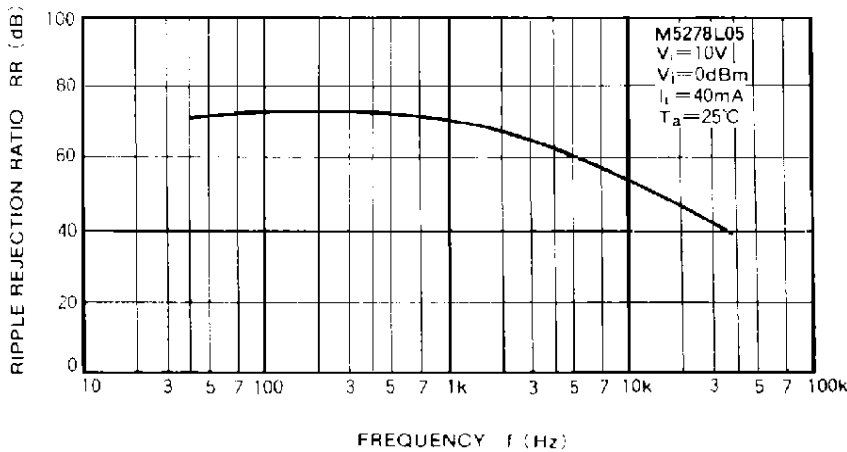

# M5278LXX, M5278LXXM

## (5V, 5.6V, 8V, 9V, 10V, 12V, 15V) 3-TERMINAL FIXED POSITIVE OUTPUT VOLTAGE REGULATOR (WITH FOLD-BACK PROTECTION CIRCUIT)

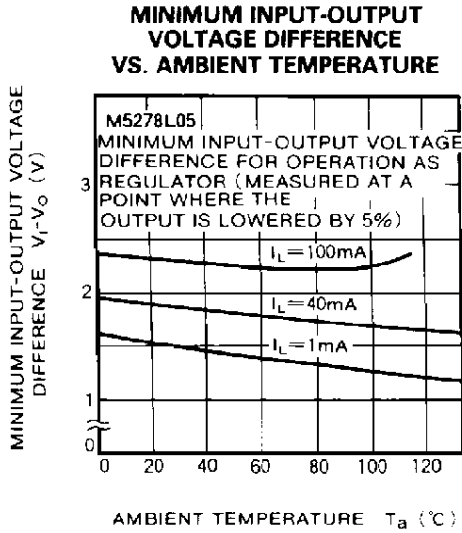

### FOLD-BACK PROTECTION CIRCUIT

The M5278L series has been designed to be complete with three-pin, 78L type regulators manufactured by other companies for applications with loading currents in the 100mA class. They additionally have an internalized fold-back protection circuit for protection against shorted loads.

Other 78L units do have an internalized protection circuit known as a drooping type circuit that are rather simple, merely limiting maximum loading current. When large current begins to flow in these units due to a short circuit, abnormal temperatures are generated leading to breakdown and effective setting reliability.

As shown in the diagram, the fold-back protection circuit employed in the M5278L decreases immediately excessive current caused by a short in the load. This not only improves set reliability but permits the elimination of such protection circuits as fuses in the protection circuit.

### PRECAUTIONS FOR USE

The current-control circuit requires that, as an IC power supply, this device be operated within the fold-back operating range shown in the accompanying chart.

### OUTPUT VOLTAGE VS. LOAD CURRENT

