



中山市晶明光电科技有限公司  
ZHONSHAN SILSMART OPTOELECTRONICS CO., LTD.

SILSMART

Device Number: JMDL-3RE-034

REV: 1.0

3.0mm Round Type LED Lamps

Model No.: **3R49R51D-EB(1)**

ECN:

Page: 1/4

■ Features :

- High radiant intensity
- Choice of various viewing angles
- Reliable and robust

■ Descriptions :

- The series is specially designed for applications requiring higher brightness.
- The led lamps are available with different colors, intensities epoxy colors, etc.

■ Applications :

- TV set
- Monitor
- Telephone
- Computer

■ Package Dimensions:

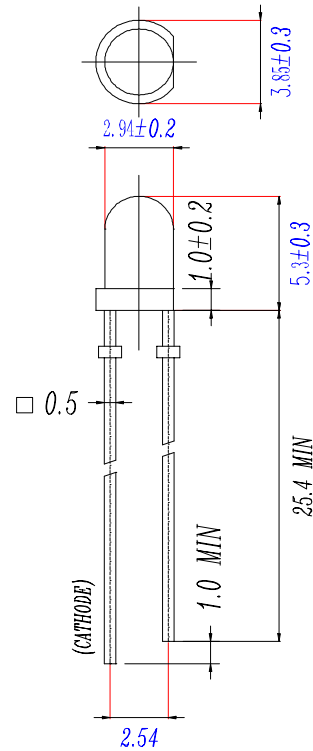

- Notes:**
1. All dimensions are in millimetres
  2. An epoxy meniscus may extend about 1.5mm(0.059") down to the lead.
  3. Tolerances unless Dimension ±0.25mm.

PART NO.	Chip		Lens Color
	Material	Emitted Color	
3R49R51D-EB(1)	GaAsP/GaP	Red	Tinted Diffused

Address: 4/F., Bld. C1, Fuwan Industrial Zone, Shiqi, Zhongshan, Guangdong, P. R. China

TEL : (+86 760) 8323449 8324139

FAX : (+86 760) 8321064 8324300

E-mail: sales @ silsmart.com

Prepared by: Angel

Prepared date: 04-6-4

403055



# 中山市晶明光电科技有限公司

ZHONSHAN SILSMART OPTOELECTRONICS CO., LTD.

Device Number: JMDL-3RE-034

REV: 1.0

## 3.0mm Round Type LED Lamps

Model No.: **3R49R51D-EB(1)**

ECN: \_\_\_\_\_

Page: 2/4

### Absolute Maximum Ratings at Ta = 25°C

Parameter	Symbol	Rating	Unit
Forward Current	IF	30	mA
Operating Temperature	Topr	-40 to +85	°C
Storage Temperature	Tstg	-40 to +100	°C
Soldering Temperature	Tsol	260 ± 5	°C
Power Dissipation	Pd	100	mW
Peak Forward Current	IF (Peak)	100	mA
Reverse Voltage	VR	5	V

Note: \*1:IFP Conditions --Pulse Width  $\leq$  1msec and Duty  $\leq$  1/10.

\*2:Soldering time  $\leq$  5 seconds.

### Electro-Optical Characteristics (Ta=25°C)

Parameter	Symbol	Condition	Min.	Typ.	Max.	Unit
Forward Voltage	VF	IF= 20 mA	/	2.0	2.4	V
Reverse Current	IR	VR= 5 V	/	/	10	$\mu$ A
Luminous Intensity	Iv	IF= 20 mA	2000.0	4000.0	/	mcd
Viewing Angle	2 $\theta$ 1/2	IF= 20 mA	/	70	/	deg
Peak Wavelength	$\lambda$ p	IF= 20 mA	/	648	/	nm
Dominant Wavelength	$\lambda$ d	IF= 20 mA	/	636	/	nm
Spectrum Radiation Bandwidth	$\Delta \lambda$	IF= 20 mA	/	40	/	nm

Address:4/F. , Bld. C1, Fuan Industrial Zone, Shiqi, Zhongshan, Guangdong, P. R. China

TEL : (+86 760) 8323449 8324139

Prepared by : Angel

FAX : (+86 760) 8321064 8324300

Prepared date : 04-6-4

E-mail:sales @ silsmart.com

403055



3.0mm Round Type LED Lamps

Model No.: 3R49R51D-EB(1)

ECN: \_\_\_\_\_

Page: 3/4

■ Typical Electro-Optical Characteristic Curves:

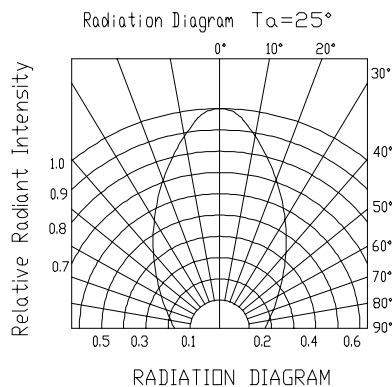
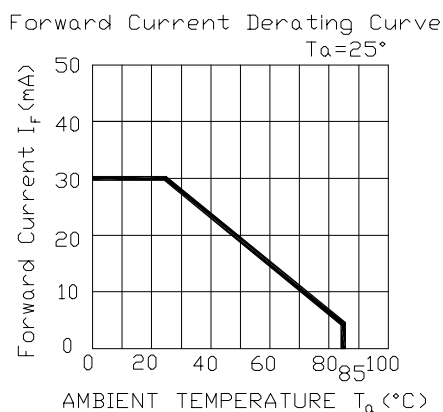
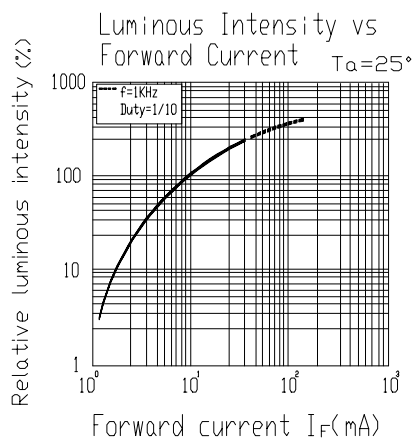
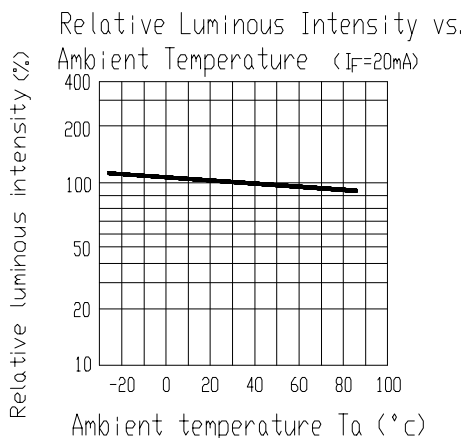
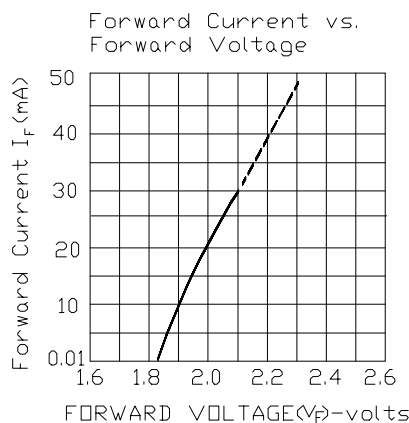
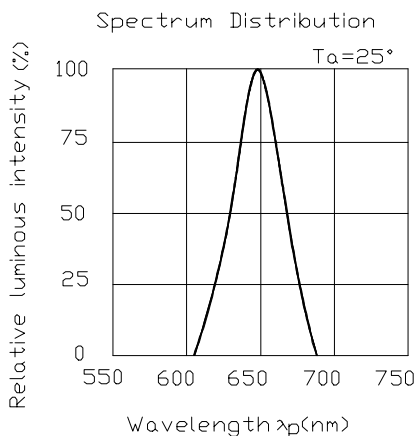



中山市晶明光电科技有限公司  
ZHONSHAN SILSMART OPTOELECTRONICS CO., LTD.

Device Number: JMDL-3RE-034

REV: 1.0

3.0mm Round Type LED Lamps

Model No.: 3R49R51D-EB(1)

ECN: \_\_\_\_\_

Page: 4/4

■ Reliability test items and conditions:

NO	Item	Test Conditions	Test Hours/Cycle	Sample size	Ac/Re
1	Solder Heat	TEMP : 260°C ± 5 °C	10 SEC	76 PCS	0/1
2	Temperature Cycle	H : +100°C 15min ∫ 5 min L : -40°C 15min	300 CYCLES	76 PCS	0/1
3	Thermal Shock	H : +100°C 5min ∫ 10 sec L : -10°C 5min	300 CYCLES	76 PCS	0/1
4	High Temperature Storage	TEMP : 100°C	1000 HRS	76 PCS	0/1
5	Low Temperature Storage	TEMP : -40°C	1000 HRS	76 PCS	0/1
6	DC Operating Life	TEMP : 25°C IF = 20mA	1000 HRS	76 PCS	0/1
7	High Temperature/ High Humidity	85°C / 85% RH	1000 HRS	76 PCS	0/1

Address: 4/F., Bld. C1, Fuan Industrial Zone, Shiqi, Zhongshan, Guangdong, P. R. China

TEL : (+86 760) 8323449 8324139

Prepared by : Angel

FAX : (+86 760) 8321064 8324300

Prepared date : 04-6-4

E-mail: sales @ silsmart.com

403055