



30CTH02  
 30CTH02S  
 30CTH02-1  
 30CTH02FP

## Hyperfast Rectifier

### Features

- Hyperfast Recovery Time
- Low Forward Voltage Drop
- Low Leakage Current
- 175°C Operating Junction Temperature

$t_{rr} = 30\text{ns max.}$   
 $I_{F(AV)} = 30\text{Amp}$   
 $V_R = 200\text{V}$

### Description/ Applications

International Rectifier's 200V series are the state of the art Hyperfast recovery rectifiers specifically designed with optimized performance of forward voltage drop and hyperfast recovery time.







The planar structure and the platinum doped life time control, guarantee the best overall performance, ruggedness and reliability characteristics.

These devices are intended for use in the output rectification stage of SMPS, UPS, DC-DC converters as well as free-wheeling diode in low voltage inverters and chopper motor drives.

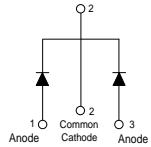
Their extremely optimized stored charge and low recovery current minimize the switching losses and reduce over dissipation in the switching element and snubbers.

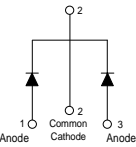
### Absolute Maximum Ratings

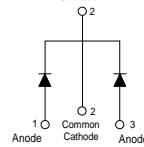
Parameters	Max	Units
$V_{RRM}$ Peak Repetitive Reverse Voltage	200	V
$I_{F(AV)}$ Average Rectified Forward Current @ $T_C = 159^\circ\text{C}$ Per Diode @ $T_C = 125^\circ\text{C}$ (FULLPACK) Per Diode	15	A
	30	
$I_{FSM}$ Non Repetitive Peak Surge Current @ $T_J = 25^\circ\text{C}$	200	
$T_J, T_{STG}$ Operating Junction and Storage Temperatures	- 65 to 175	$^\circ\text{C}$

Case Styles			
<p>30CTH02</p>  <p>Base Common Cathode</p>  <p>1 Anode 2 Common Cathode 3 Anode</p> <p>TO-220AB</p>	<p>30CTH02S</p>  <p>Base Common Cathode</p>  <p>1 Anode 2 Common Cathode 3 Anode</p> <p>D<sup>2</sup>PAK</p>	<p>30CTH02-1</p>  <p>Base Common Cathode</p>  <p>1 Anode 2 Common Cathode 3 Anode</p> <p>TO-262</p>	<p>30CTH02FP</p>  <p>1 Anode 2 Common Cathode 3 Anode</p> <p>TO-220 FULLPACK</p>

**Electrical Characteristics @  $T_J = 25^\circ\text{C}$  (unless otherwise specified)**

Parameters	Min	Typ	Max	Units	Test Conditions
$V_{BR}, V_r$ Breakdown Voltage, Blocking Voltage	200	-	-	V	$I_R = 100\mu\text{A}$
$V_F$ Forward Voltage	-	0.92	1.05	V	$I_F = 15\text{A}, T_J = 25^\circ\text{C}$
	-	0.78	0.85	V	$I_F = 15\text{A}, T_J = 125^\circ\text{C}$
$I_R$ Reverse Leakage Current	-	-	10	$\mu\text{A}$	$V_R = V_R \text{ Rated}$
	-	5	300	$\mu\text{A}$	$T_J = 125^\circ\text{C}, V_R = V_R \text{ Rated}$
$C_T$ Junction Capacitance	-	57	-	pF	$V_R = 200\text{V}$
$L_S$ Series Inductance	-	8	-	nH	Measured lead to lead 5mm from package body

**Dynamic Recovery Characteristics @  $T_C = 25^\circ\text{C}$  (unless otherwise specified)**

Parameters	Min	Typ	Max	Units	Test Conditions
$t_{rr}$ Reverse Recovery Time	-	-	35	ns	$I_F = 1\text{A}, di_F/dt = 50\text{A}/\mu\text{s}, V_R = 30\text{V}$
	-	-	30		$I_F = 1\text{A}, di_F/dt = 100\text{A}/\mu\text{s}, V_R = 30\text{V}$
	-	26	-	A	$T_J = 25^\circ\text{C}$
	-	40	-		$T_J = 125^\circ\text{C}$
$I_{RRM}$ Peak Recovery Current	-	2.8	-	A	$I_F = 15\text{A}$ $di_F/dt = 200\text{A}/\mu\text{s}$ $V_R = 160\text{V}$
	-	6.0	-		
$Q_{rr}$ Reverse Recovery Charge	-	37	-	nC	$T_J = 25^\circ\text{C}$
	-	120	-		$T_J = 125^\circ\text{C}$

**Thermal - Mechanical Characteristics**

Parameters	Min	Typ	Max	Units
$T_J$ Max. Junction Temperature Range	-	-	175	$^\circ\text{C}$
$T_{Stg}$ Max. Storage Temperature Range	- 65	-	175	
$R_{thJC}$ ① Thermal Resistance, Per Diode Junction to Case Fullpack (Per Diode)	-	-	1.1	$^\circ\text{C}/\text{W}$
	-	-	3.5	
Device Marking	30CTH02			Case Style TO-220
	30CTH02S			Case Style D <sup>2</sup> Pak
	30CTH02-1			Case Style TO-262
	30CTH02FP			Case Style Fullpack

① Mounting Surface, Flat, Smooth and Greased

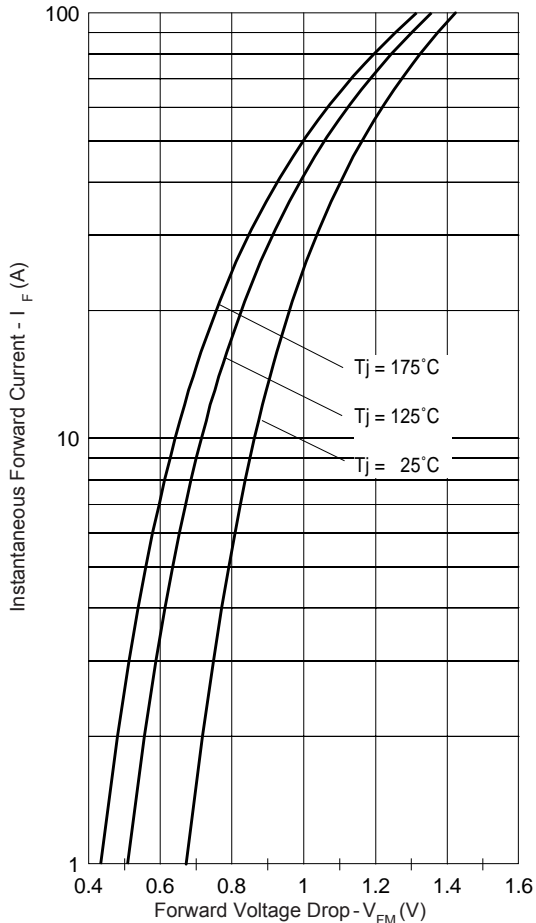

Fig. 1 - Typical Forward Voltage Drop Characteristics

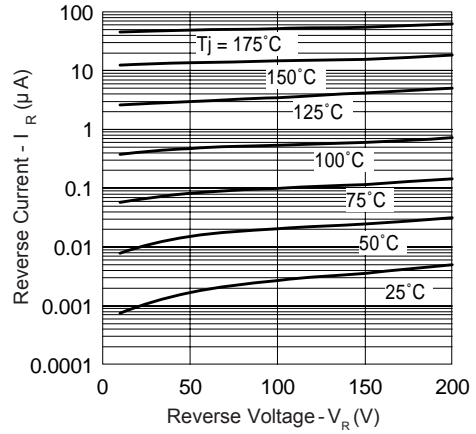

Fig. 2 - Typical Values of Reverse Current Vs. Reverse Voltage

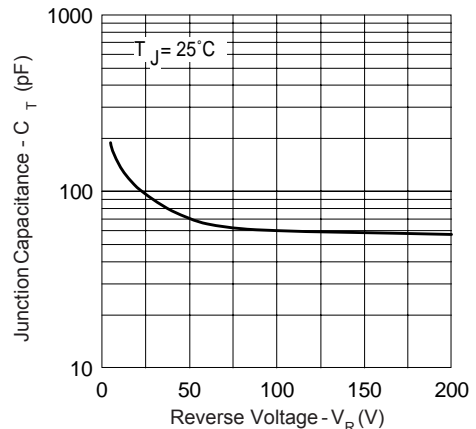

Fig. 3 - Typical Junction Capacitance Vs. Reverse Voltage

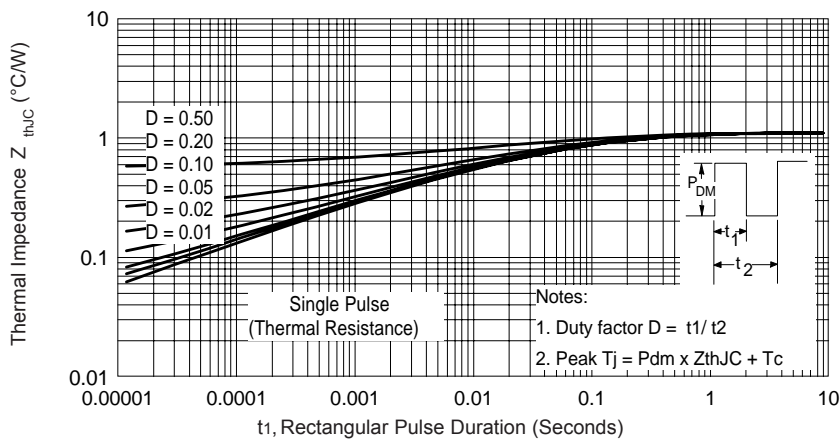

Fig. 4 - Max. Thermal Impedance  $Z_{thJC}$  Characteristics

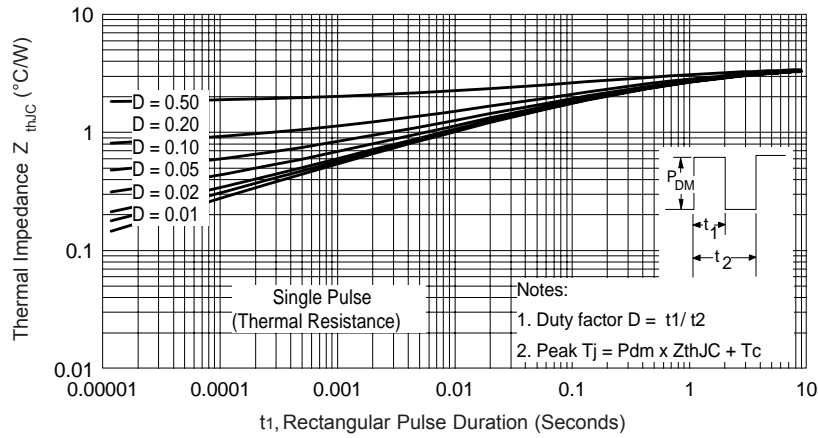

Fig. 5 - Max. Thermal Impedance  $Z_{thJC}$  Characteristics (FULLPACK)

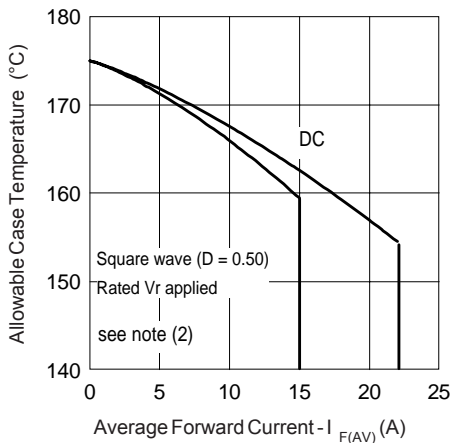

Fig. 6 - Max. Allowable Case Temperature Vs. Average Forward Current

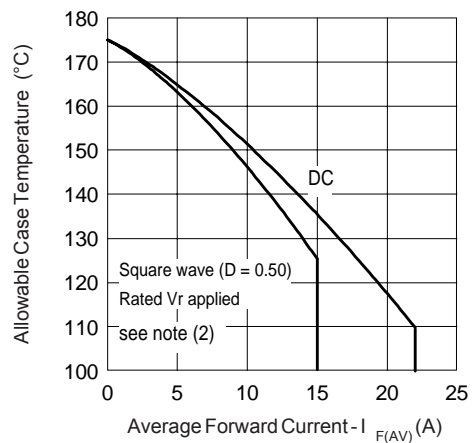

Fig. 7 - Max. Allowable Case Temperature Vs. Average Forward Current (FULLPACK)

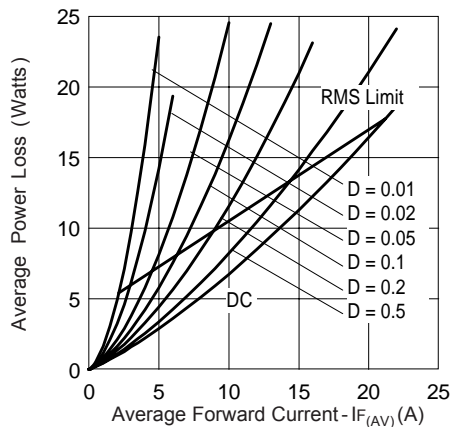
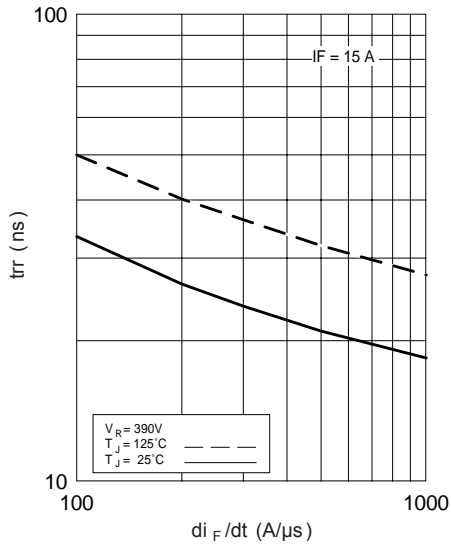
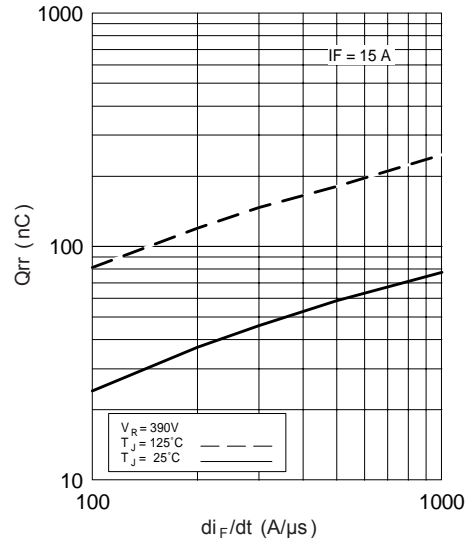

Fig. 8 - Forward Power Loss Characteristics

(2) Formula used:  $T_c = T_j - (P_d + P_{d_{REV}}) \times R_{thJC}$ ;  
 $P_d = \text{Forward Power Loss} = I_{F(AV)} \times V_{FM} @ (I_{F(AV)}/D)$   
 (see Fig. 8);  
 $P_{d_{REV}} = \text{Inverse Power Loss} = V_{R1} \times I_R (1 - D)$ ;  
 $I_R @ V_{R1} = \text{rated } V_R$



**Fig. 9 - Typical Reverse Recovery vs.  $di_F/dt$**



**Fig. 10 - Typical Stored Charge vs.  $di_F/dt$**

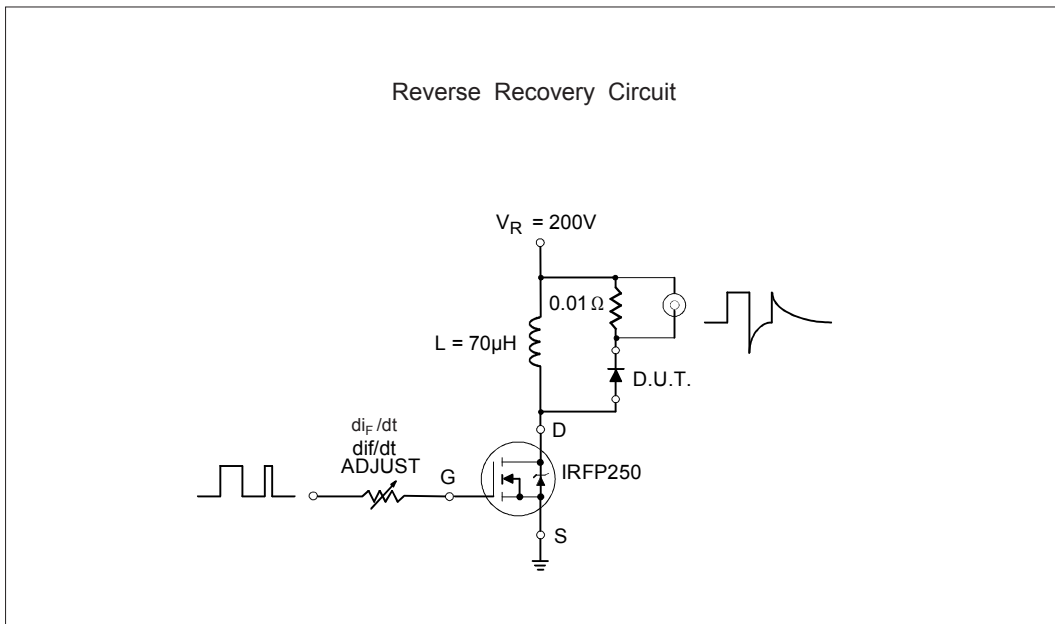

**Fig. 11 - Reverse Recovery Parameter Test Circuit**

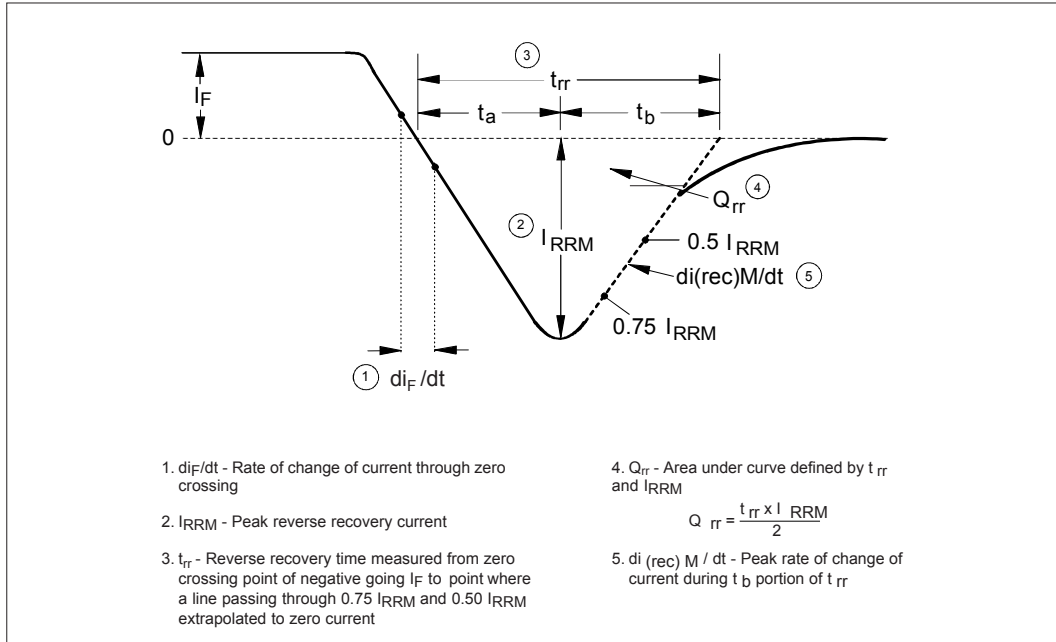
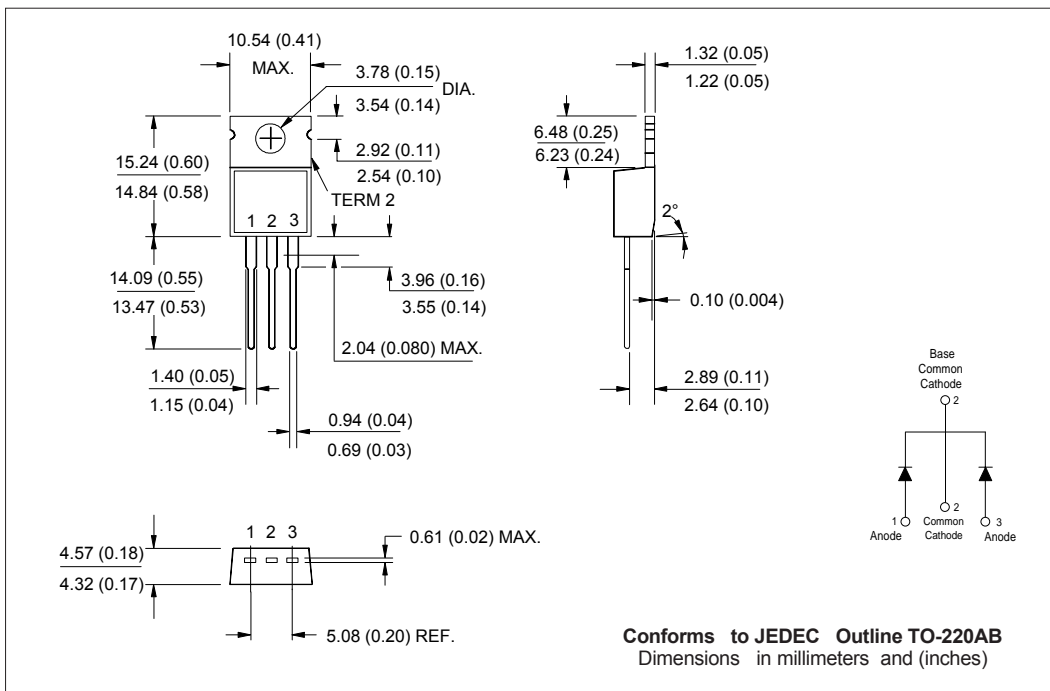
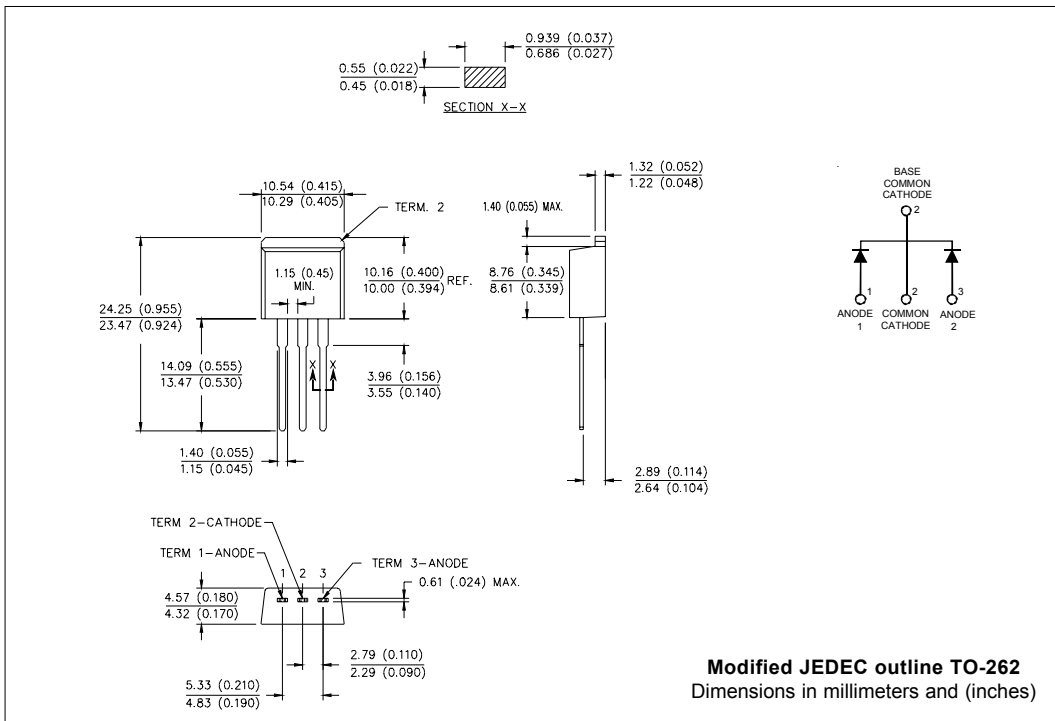
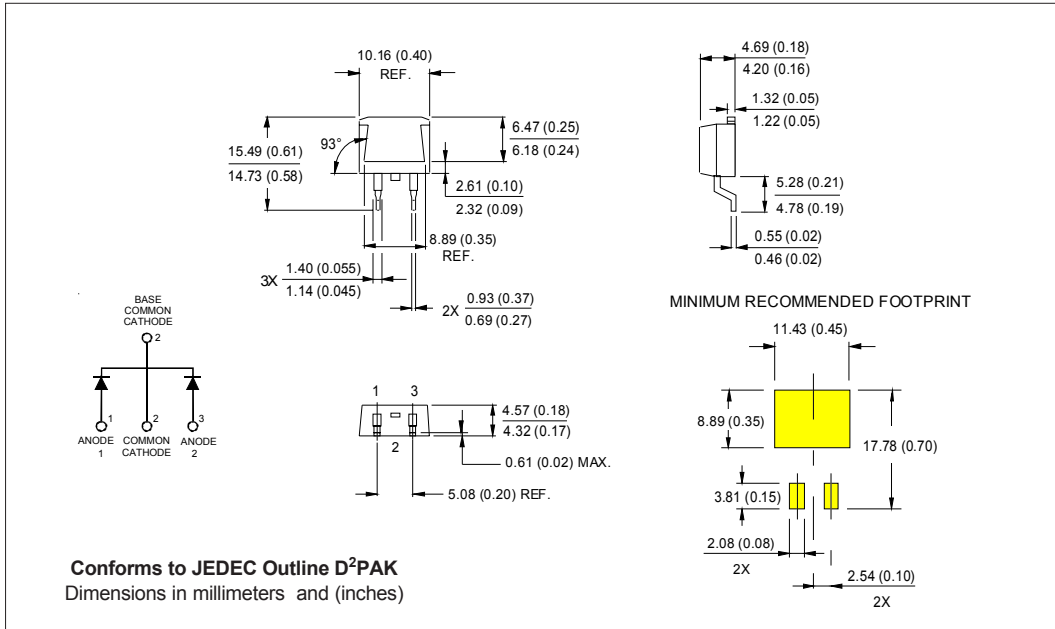

Fig. 13 - Reverse Recovery Waveform and Definitions

Outline Table



Outline Table



Outline Table

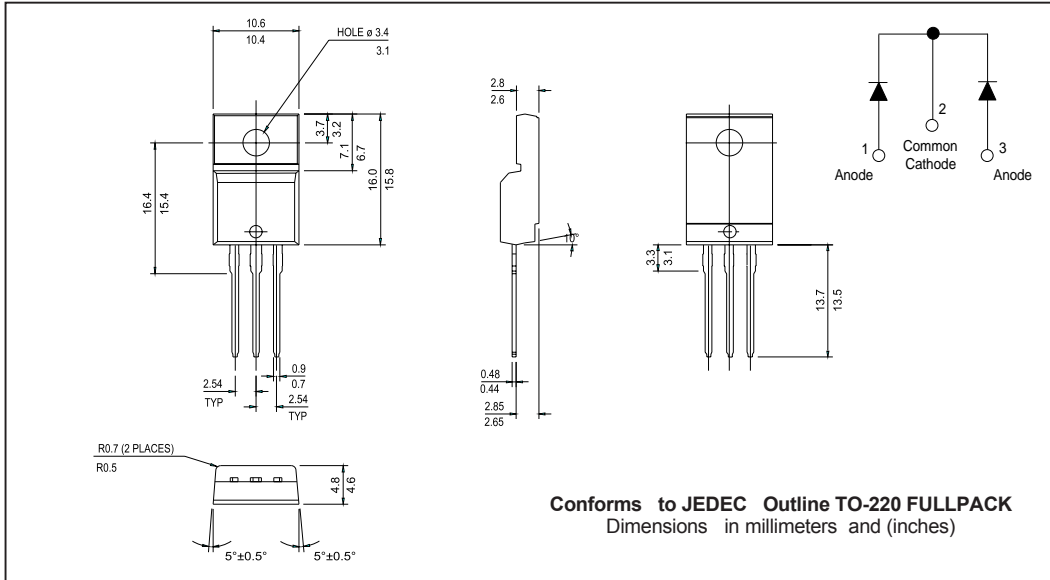

Tape & Reel Information

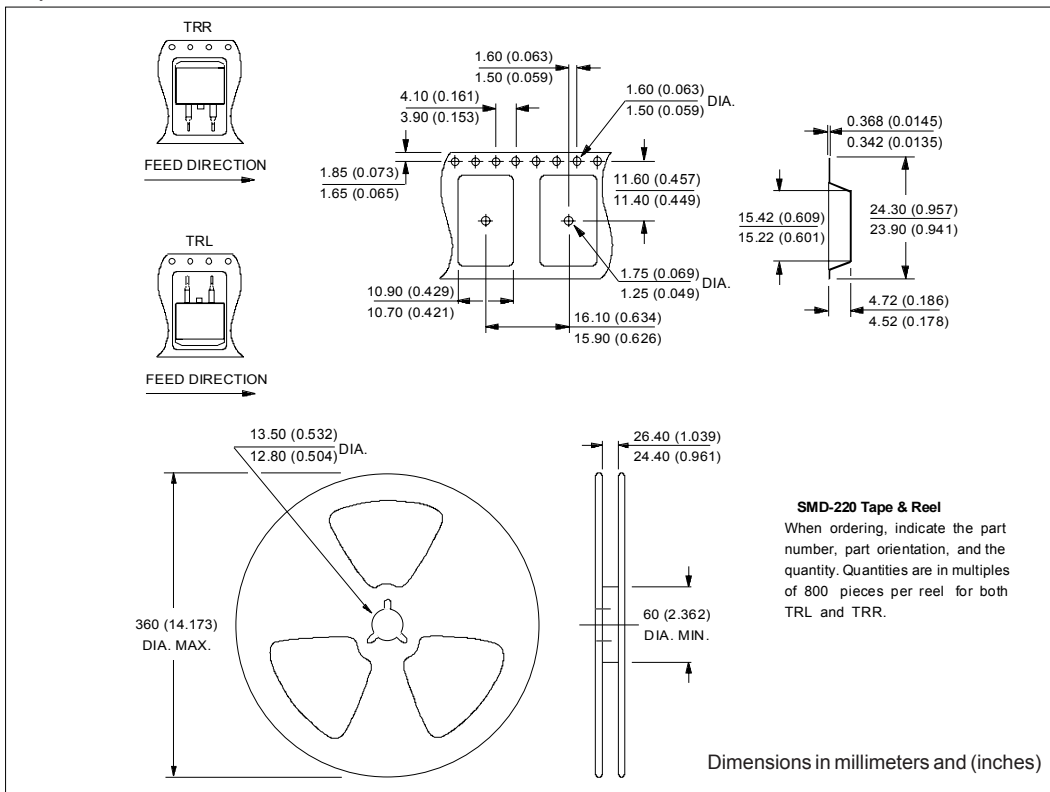

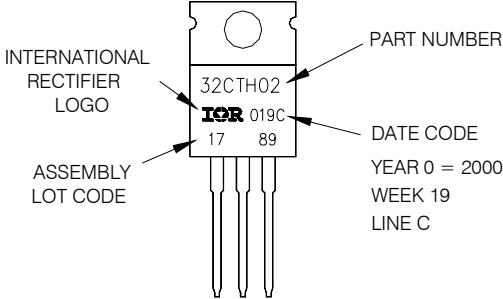
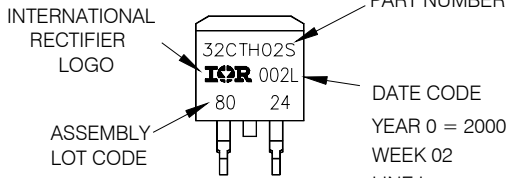
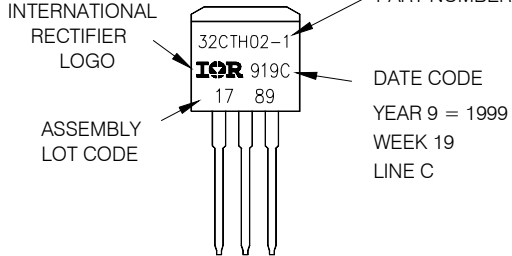
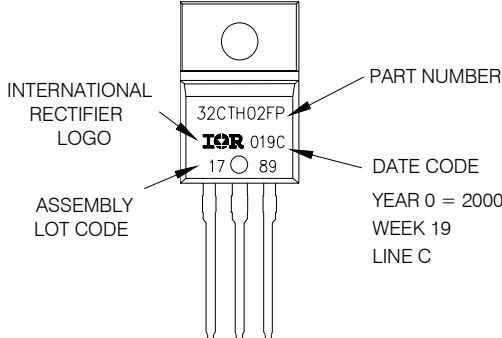

Part Marking Information

<p>EXAMPLE: THIS IS A 32CTH02          LOT CODE 1789          ASSEMBLED ON WW 19, 2000          IN THE ASSEMBLY LINE "C"</p>	
<p>TO-220AB</p>	<p>YEAR 0 = 2000          WEEK 19          LINE C</p>
<p>EXAMPLE: THIS IS A 32CTH02S          LOT CODE 8024          ASSEMBLED ON WW 02, 2000          IN THE ASSEMBLY LINE "L"</p>	
<p>D<sup>2</sup>PAK</p>	<p>YEAR 0 = 2000          WEEK 02          LINE L</p>
<p>EXAMPLE: THIS IS A 32CTH02-1          LOT CODE 1789          ASSEMBLED ON WW 19, 1999          IN THE ASSEMBLY LINE "C"</p>	
<p>TO-262</p>	<p>YEAR 9 = 1999          WEEK 19          LINE C</p>
<p>EXAMPLE: THIS IS A 32CTH02FP          LOT CODE 1789          ASSEMBLED ON WW 19, 2000          IN THE ASSEMBLY LINE "C"</p>	
<p>FULLPACK</p>	<p>YEAR 0 = 2000          WEEK 19          LINE C</p>

Ordering Information Table

Device Code															
	<table border="1" style="margin: auto;"> <tr> <td style="padding: 5px;"><b>30</b></td> <td style="padding: 5px;"><b>C</b></td> <td style="padding: 5px;"><b>T</b></td> <td style="padding: 5px;"><b>H</b></td> <td style="padding: 5px;"><b>02</b></td> <td style="padding: 5px;"><b>-1</b></td> <td style="padding: 5px;"><b>TRL</b></td> </tr> <tr> <td style="text-align: center;">①</td> <td style="text-align: center;">②</td> <td style="text-align: center;">③</td> <td style="text-align: center;">④</td> <td style="text-align: center;">⑤</td> <td style="text-align: center;">⑥</td> <td style="text-align: center;">⑦</td> </tr> </table>	<b>30</b>	<b>C</b>	<b>T</b>	<b>H</b>	<b>02</b>	<b>-1</b>	<b>TRL</b>	①	②	③	④	⑤	⑥	⑦
<b>30</b>	<b>C</b>	<b>T</b>	<b>H</b>	<b>02</b>	<b>-1</b>	<b>TRL</b>									
①	②	③	④	⑤	⑥	⑦									
<b>1</b>	- Current Rating (30 = 30A)														
<b>2</b>	- C = Common Cathode														
<b>3</b>	- T = TO-220														
<b>4</b>	- H = HyperFast Recovery														
<b>5</b>	- Voltage Rating (02 = 200V)														
<b>6</b>	- None = TO-220AB S = D <sup>2</sup> Pak -1 = TO-262 Option FP = TO-220 FULLPACK														
<b>7</b>	- None = Tube (50 pieces) TRL = Tape & Reel (Left Oriented - for D <sup>2</sup> Pak only) TRR = Tape & Reel (Right Oriented - for D <sup>2</sup> Pak only)														

Data and specifications subject to change without notice.  
This product has been designed and qualified for Industrial Level.  
Qualification Standards can be found on IR's Web site.