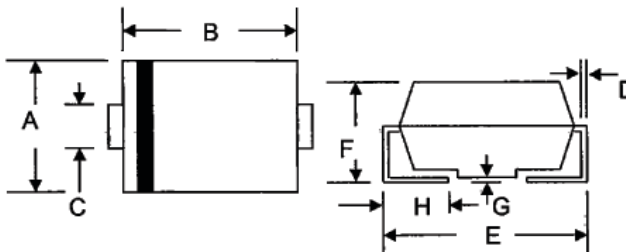

**Features**

- Glass Passivated Die Construction
- Ideally Suited for Automatic Assembly
- Low Forward Voltage Drop, High Efficiency
- Surge Overload Rating to 50A Peak
- Low Power Loss
- Super-Fast Recovery Time
- Plastic Case Material has UL Flammability Classification Rating 94V-O

**Mechanical Data**

- Case: SMB/DO-214AA, Molded Plastic
- Terminals: Solder Plated, Solderable per MIL-STD-750, Method 2026
- Polarity: Cathode Band or Cathode Notch
- Marking: Type Number
- Weight: 0.093 grams (approx.)
- **Lead Free: For RoHS / Lead Free Version, Add "-LF" Suffix to Part Number, See Page 4**

SMB/DO-214AA		
Dim	Min	Max
A	3.30	3.94
B	4.06	4.70
C	1.91	2.11
D	0.152	0.305
E	5.08	5.59
F	2.13	2.44
G	0.051	0.203
H	0.76	1.27
All Dimensions in mm		

**Maximum Ratings and Electrical Characteristics** @ $T_A=25^\circ\text{C}$  unless otherwise specified

Characteristic	Symbol	ER2A	ER2B	ER2C	ER2D	ER2E	ER2G	ER2J	Unit
Peak Repetitive Reverse Voltage	$V_{RRM}$	50	100	150	200	300	400	600	V
Working Peak Reverse Voltage	$V_{RWM}$								
DC Blocking Voltage	$V_R$								
RMS Reverse Voltage	$V_{R(RMS)}$	35	70	105	140	210	280	420	V
Average Rectified Output Current @ $T_L = 110^\circ\text{C}$	$I_o$	2.0							A
Non-Repetitive Peak Forward Surge Current 8.3ms Single half sine-wave superimposed on rated load (JEDEC Method)	$I_{FSM}$	50							A
Forward Voltage @ $I_f = 2.0\text{A}$	$V_{FM}$	0.95				1.25	1.7		V
Peak Reverse Current @ $T_A = 25^\circ\text{C}$ At Rated DC Blocking Voltage @ $T_A = 100^\circ\text{C}$	$I_{RM}$					5.0 500			$\mu\text{A}$
Reverse Recovery Time (Note 1)	$t_{rr}$					35			nS
Typical Junction Capacitance (Note 2)	$C_j$					25			pF
Typical Thermal Resistance (Note 3)	$R_{\theta JL}$					20			$^\circ\text{C/W}$
Operating and Storage Temperature Range	$T_j, T_{STG}$	-65 to +150							$^\circ\text{C}$

Note: 1. Measured with  $I_f = 0.5\text{A}$ ,  $I_R = 1.0\text{A}$ ,  $I_{rr} = 0.25\text{A}$ . See figure 5.  
 2. Measured at 1.0 MHz and applied reverse voltage of 4.0 V DC.  
 3. Mounted on P.C. Board with 8.0mm<sup>2</sup> land area.

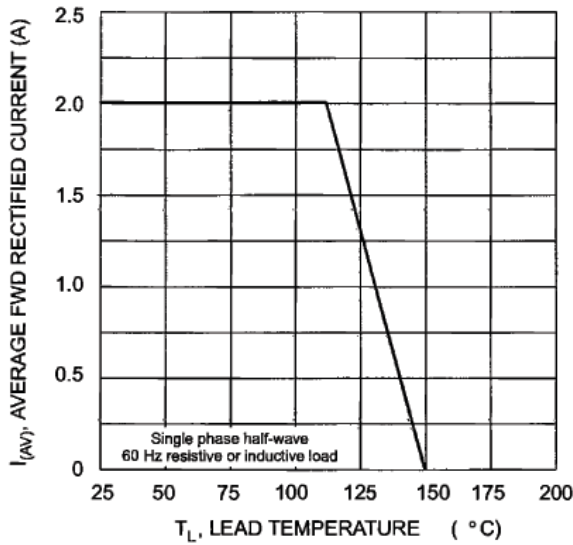

Fig. 1 Forward Current Derating Curve

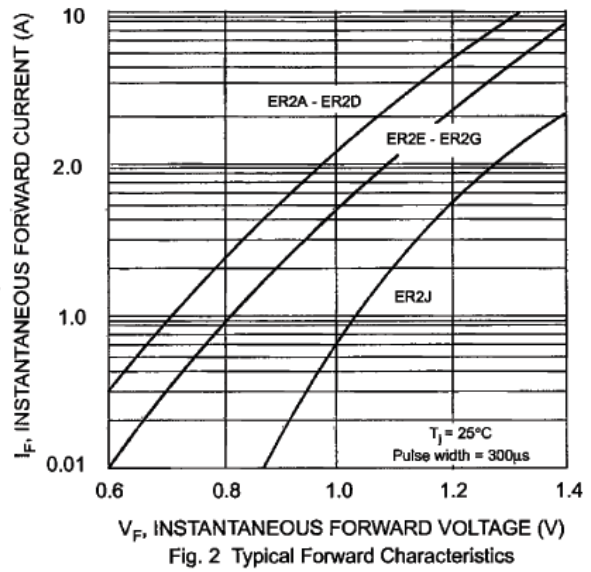

Fig. 2 Typical Forward Characteristics

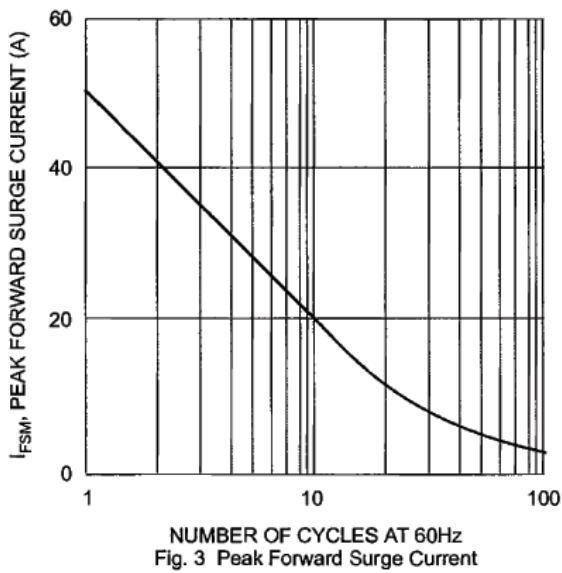

Fig. 3 Peak Forward Surge Current

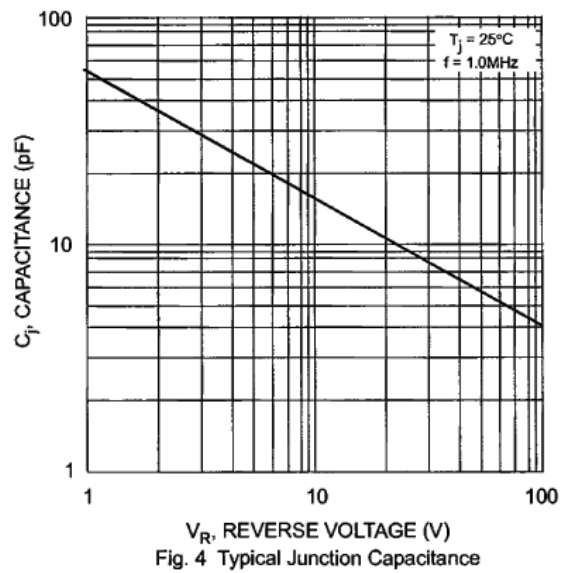
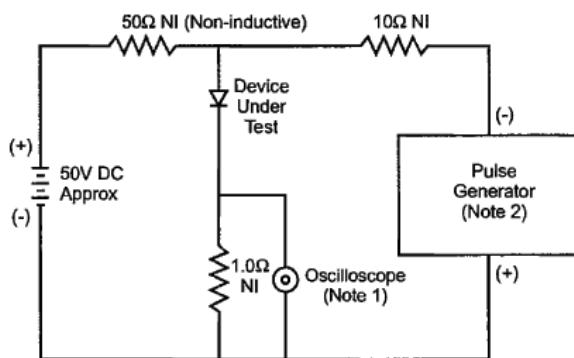
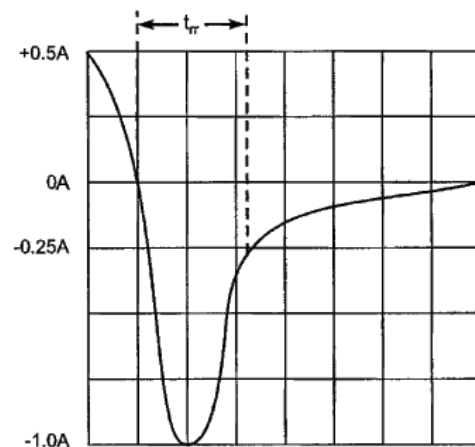

Fig. 4 Typical Junction Capacitance



- Notes:  
 1. Rise Time = 7.0ns max. Input Impedance = 1.0MΩ, 22pF.  
 2. Rise Time = 10ns max. Input Impedance = 50Ω.



Set time base for 5/10ns/cm

Fig. 5 Reverse Recovery Time Characteristic and Test Circuit

**MARKING INFORMATION**

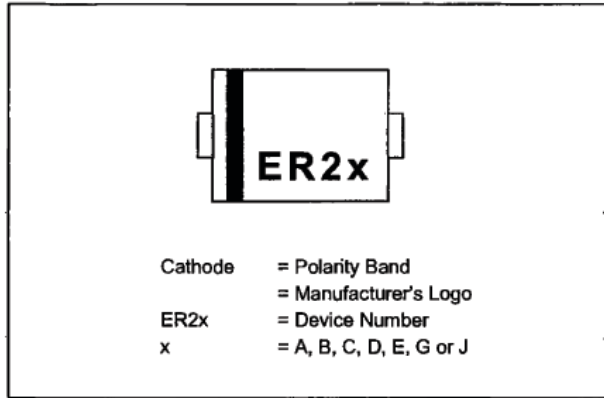

**RECOMMENDED FOOTPRINT**

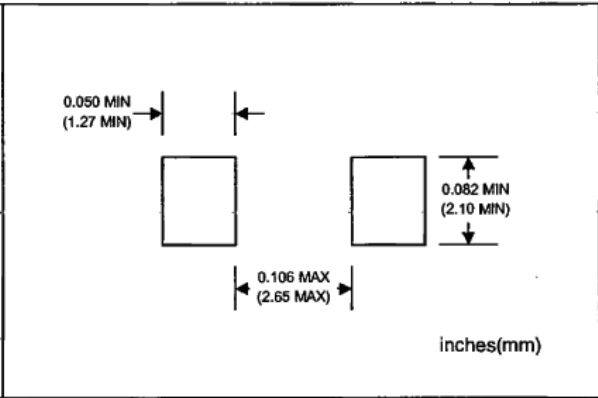

**PACKAGING INFORMATION**

**TAPE & REEL**

Reel Diameter (mm)	Quantity (PCS)	Inner Box Size L x W x H (mm)	Quantity (PCS)	Carton Size L x W x H (mm)	Quantity (PCS)	Approx. Gross Weight (KG)
330	3,000	340 x 337 x 45	6,000	370 x 370 x 420	48,000	14.0

**Note:** 1. Paper reel, white or gray color.  
 2. Components are packed in accordance with EIA standard 481-1 and 481-2.



### ORDERING INFORMATION

Product No.	Package Type	Shipping Quantity
ER2A-T3	SMB	3000/Tape & Reel
ER2B-T3	SMB	3000/Tape & Reel
ER2C-T3	SMB	3000/Tape & Reel
ER2D-T3	SMB	3000/Tape & Reel
ER2E-T3	SMB	3000/Tape & Reel
ER2G-T3	SMB	3000/Tape & Reel
ER2J-T3	SMB	3000/Tape & Reel

1. Shipping quantity given is for minimum packing quantity only. For minimum order quantity, please consult the Sales Department.
2. To order RoHS / Lead Free version (with Lead Free finish), add "-LF" suffix to part number above. For example, ER2A-T3-LF.

Surge Components Inc.  
95 East Jeffryn Boulevard  
Deer Park, NY 11729  
Tel: 631-595-1818  
www.surgecomponents.com

*We power your everyday.*