

Am25S07/Am25S08

Hex/Quad Parallel D Registers with Register Enable

DISTINCTIVE CHARACTERISTICS

- 4-bit and 6-bit high-speed parallel registers
- Positive edge triggered D flip-flops
- Common clock and common enable

GENERAL DESCRIPTION

The Am25S07 is a 6-bit, high-speed Schottky register with a buffered common register enable. The Am25S08 is a 4-bit register with a buffered common register enable. The devices are similar to the Am54S/74S174 and Am54S/74S175 but feature the common register enable rather than common clear.

Both registers will find application in digital systems where information is associated with a logic gating signal. When the enable is LOW, data on the D inputs is stored in the register on the positive going edge of the clock pulse. When the enable is HIGH, the register will not change state regardless of the clock or data input transitions.

BLOCK DIAGRAM

Am25S07

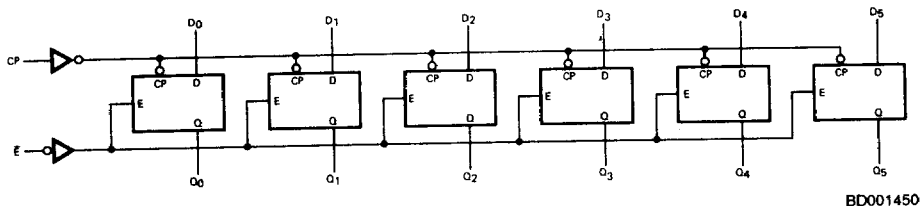

Am25S08

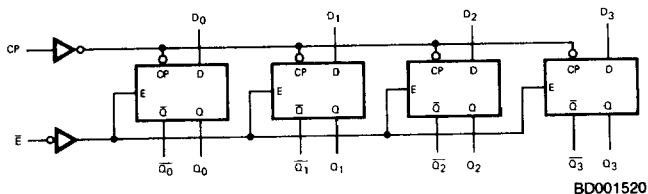

RELATED PRODUCTS

Part No.	Description
Am25LS07/08	Low Power Versions
Am2918	Quad D Register
Am2919	Quad Register
Am29821 - 26	8, 9, 10-Bit Register

CONNECTION DIAGRAM Top View

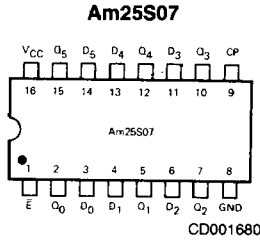

Note: Pin 1 is marked for orientation

LOGIC SYMBOL Am25S07

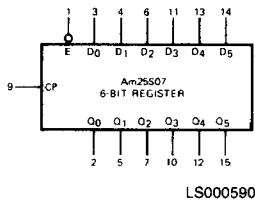

METALLIZATION AND PAD LAYOUT Am25S07

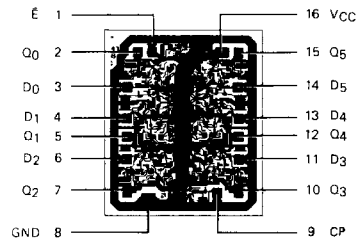

DIE SIZE: 0.070" x 0.083"

ORDERING INFORMATION

AMD products are available in several packages and operating ranges. The order number is formed by a combination of the following: Device number, speed option (if applicable), package type, operating range and screening option (if desired).

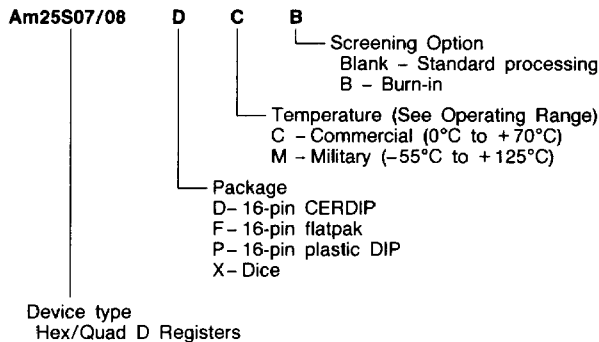

Valid Combinations	
Am25S07/08	PC DC, DM FM XC, XM

Valid Combinations

Consult the AMD sales office in your area to determine if a device is currently available in the combination you wish.

CONNECTION DIAGRAM Top View

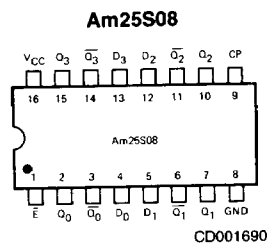

Note: Pin 1 is marked for orientation

LOGIC SYMBOL Am25S08

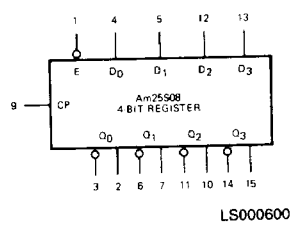

METALLIZATION AND PAD LAYOUT Am25S08

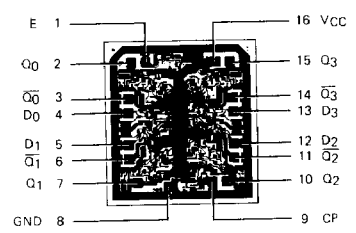

DIE SIZE: 0.067" x 0.073"

PIN DESCRIPTION

Pin No.	Name	I/O	Description
	D_i	I	The D flip-flop data inputs.
1	\bar{E}	I	Enable. When the enable is LOW, data on the D_i inputs is transferred to the Q_i outputs on the LOW-to-HIGH clock transition. When the enable is HIGH, the Q_i outputs do not change regardless of the data or clock input transitions.
9	CP	I	Clock Pulse for the register. Enters data on the LOW-to-HIGH transition.
	Q_i	O	The TRUE register outputs.
	\bar{Q}_i	O	The complement register outputs.

FUNCTION TABLE

Inputs			Outputs	
\bar{E}	D_i	CP	Q_i	\bar{Q}_i
H	X	X	NC	NC
L	X	H	NC	NC
L	X	L	NC	NC
L	L	↑	L	H
L	H	↑	H	L

H = HIGH

L = LOW

X = Don't Care

↑ = LOW-to-HIGH Transition

NC = No Change

 \bar{Q}_i on Am25S08 Only

APPLICATIONS

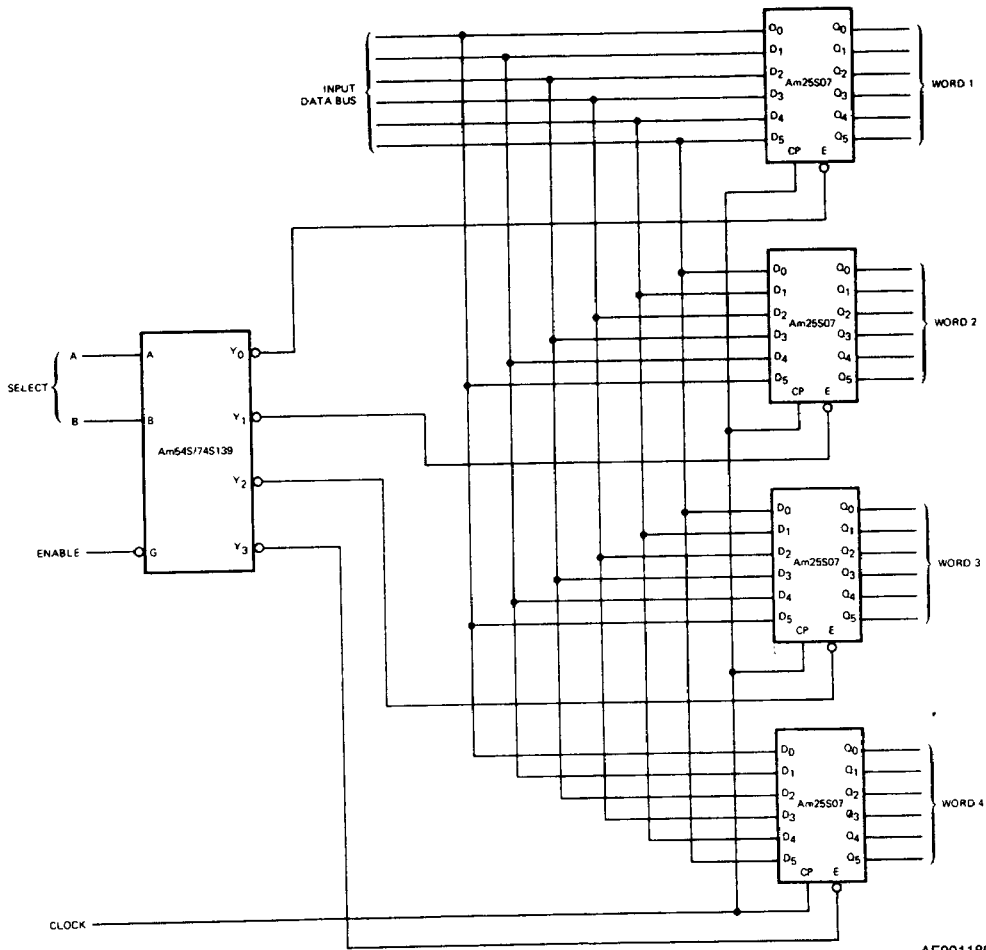

AF001180

Selective Register Loading of Data on Synchronous Clock.

ABSOLUTE MAXIMUM RATINGS

Storage Temperature	-65°C to +150°C
Temperature (Ambient) Under Bias	-55°C to +125°C
Supply Voltage to Ground Potential (Pin 16 to Pin 8) Continuous	-0.5V to +7.0V
DC Voltage Applied to Outputs For High Output State	-0.5V to +V _{CC} max
DC Input Voltage	-0.5V to +5.5V
DC Output Current, Into Outputs	30mA
DC Input Current	-30mA to +5.0mA

Stresses above those listed under **ABSOLUTE MAXIMUM RATINGS** may cause permanent device failure. Functionality at or above these limits is not implied. Exposure to absolute maximum ratings for extended periods may affect device reliability.

OPERATING RANGES

Commercial (C) Devices

Temperature	0°C to +70°C
Supply Voltage	+4.75V to +5.25V

Military (M) Devices

Temperature	-55°C to +125°C
Supply Voltage	+4.5V to +5.5V

Operating ranges define those limits over which the functionality of the device is guaranteed.

DC CHARACTERISTICS over operating range unless otherwise specified

Parameters	Description	Test Conditions (Note 2)	Min	Typ (Note 1)	Max	Units	
V _{OH}	Output HIGH Voltage	V _{CC} = MIN., I _{OH} = -1mA V _{IN} = V _{IH} or V _{IL}	XC	2.7	3.4		Volts
			XM	2.5	3.4		
V _{OL}	Output LOW Voltage	V _{CC} = MIN., I _{OL} = 20mA V _{IN} = V _{IH} or V _{IL}			0.5	Volts	
V _{IH}	Input HIGH Level	Guaranteed input logical HIGH voltage for all inputs	2.0			Volts	
V _{IL}	Input LOW Level	Guaranteed input logical LOW voltage for all inputs			0.8	Volts	
V _I	Input Clamp Voltage	V _{CC} = MIN., I _{IN} = -18mA			-1.2	Volts	
I _{IL} (Note 3)	Unit Load Input LOW Current	V _{CC} = MAX., V _{IN} = 0.5V			-2	mA	
I _{IH} (Note 3)	Unit Load Input HIGH Current	V _{CC} = MAX., V _{IN} = 2.7V			50	μA	
I _I	Input HIGH Current	V _{CC} = MAX., V _{IN} = 5.5V			1.0	mA	
I _{SC}	Output Short Circuit Current (Note 4)	V _{CC} = MAX.	-40		-100	mA	
I _{CC}	Power Supply Current (Note 5)	V _{CC} = MAX.	S07	90	144	mA	
			S08	60	96		

Notes: 1. Typical limits are at V_{CC} = 5.0V, 25°C ambient and maximum loading.

2. For conditions shown as MIN. or MAX., use the appropriate value specified under Operating Ranges for the applicable device type.

3. Actual input currents = Unit Load Current x Input Load Factor (See Loading Rules).

4. Not more than one output should be shorted at a time. Duration of the short circuit test should not exceed one second.

5. Outputs open; enable grounded; data inputs at 4.5V, measured after a momentary ground, then 4.5V applied to the clock input.

SWITCHING CHARACTERISTICS ($T_A = +25^\circ\text{C}$)

Parameters	Description	Test Conditions	Min	Typ	Max	Units
t_{PLH}	Clock to Output	$V_{CC} = 5.0\text{V}, C_L = 15\text{pF}, R_L = 280\Omega$	4	8	12	ns
t_{PHL}	Clock to Output		4	11.5	17	ns
t_{pw}	Clock Pulse Width		7			ns
t_s	Data		5.5			ns
t_e	Enable		9			ns
t_h	Data		3			ns
t_n	Enable		3			ns

Am25S07 LOADING RULES
(In STTL Unit Loads)

Input/Output	Pin Nos.	Input Unit Load	Fan-out	
			Output HIGH	Output LOW
E	1	1	-	-
Q ₀	2	-	20	10
D ₀	3	1	-	-
D ₁	4	1	-	-
Q ₁	5	-	20	10
D ₂	6	1	-	-
Q ₂	7	-	20	10
GND	8	-	-	-
CP	9	1	-	-
Q ₃	10	-	20	10
D ₃	11	1	-	-
Q ₄	12	-	20	10
D ₄	13	1	-	-
D ₅	14	1	-	-
Q ₅	15	-	20	10
V _{CC}	16	-	-	-

Am25S08 LOADING RULES
(In STTL Unit Loads)

Input/Output	Pin Nos.	Input Unit Load	Fan-out	
			Output HIGH	Output LOW
E	1	1	-	-
Q ₀	2	-	20	10
\bar{Q}_0	3	-	20	10
D ₀	4	1	-	-
D ₁	5	1	-	-
\bar{Q}_1	6	-	20	10
Q ₁	7	-	20	10
GND	8	-	-	-
CP	9	1	-	-
Q ₂	10	-	20	10
\bar{Q}_2	11	-	20	10
D ₂	12	1	-	-
D ₃	13	1	-	-
\bar{Q}_3	14	-	20	10
Q ₃	15	-	20	10
V _{CC}	16	-	-	-

A Schottky TTL Unit Load is defined as 50 μA measured at 2.7V HIGH and -2.0mA measured at 0.5V LOW.

9

SCHOTTKY INPUT/OUTPUT CURRENT INTERFACE CONDITIONS

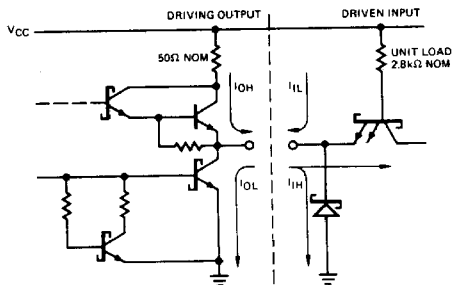

IC000150

Note: Actual current flow direction shown.