

Powerex, Inc., 200 Hillis Street, Youngwood, Pennsylvania 15697-1800 (412) 925-7272

Phase Control Modules
345-800 Amperes/400-3000 Volts

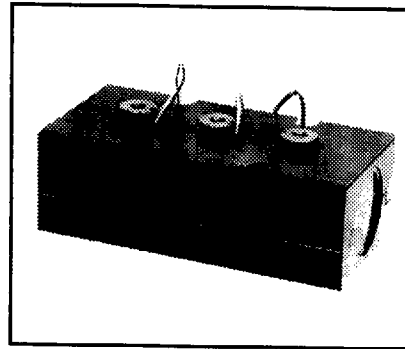
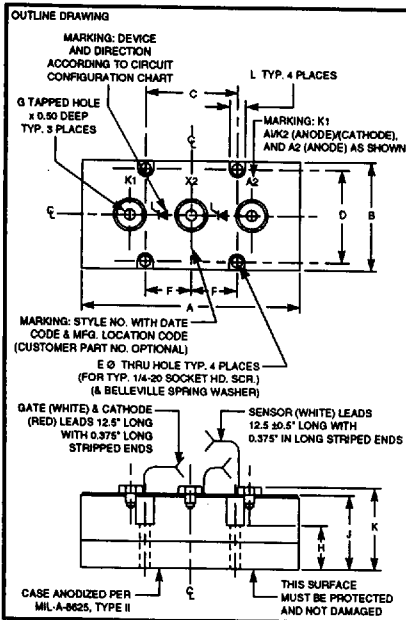

POW-R-BRIK™
Phase Control Modules
345-800 Amperes/400-3000 Volts

Outline Drawing

Z7A Outline

Dimension	Inches	Millimeters
A	6.30	153.16
B	3.02	76.70
C	3.15	80.01
D	2.47	62.73
E	0.328 Dia.	Dia. 8.33
F	1.83	46.48
G	5/16-18 UNC-2B	5/16-18 UNC-2B
H	1.27	32.25
J	2.09	53.08
K	2.25	57.15
L	0.56	14.22

Mounting Bolt (E) Torque Limit is 11 ft.-lb.

Electrical terminal (G) torque limit is 11 ft.-lb. for type Z7A and 20 ft.-lb. for Z9A.

Apply a thin coating of thermal joint compound to heat sink surface prior to module mounting.

Module weights: Z7A weighs 6 lbs. while the Z9A module weighs 11 lbs.

If incoming tests are done for isolation voltage, the voltage should be applied in a slow manner rather than abruptly imposed on the device. The voltage should be applied between the top terminals, which must be shorted together, and the metal case.

The metal case is anodized and provides added voltage isolation capability if not damaged; factory hi-pot test is achieved without the benefit of the anodized coating.

Z9A Outline

Dimension	Inches	Millimeters
A	7.50	190.50
B	3.70	93.98
C	3.15	80.01
D	3.15	80.01
E	0.328 Dia.	Dia. 8.33
F	2.03	51.56
G	3/8-16 UNC-2B	3/8-16 UNC-2B
H	1.51	38.35
J	2.52	64.00
K	2.75	69.85
L	0.56	14.22

Ordering Information:

Select the complete thirteen digit module part number you desire from the Configuration Reference Description.

Example: P3Z7ACT700W16 is a 1600 Volt, 375 Ampere Average, Dual SCR POW-R-BRIK™ Module with the standard thermistor.

Description:

Powerex POW-R-BRIK™ Modules are designed for medium and high current power control applications. POW-R-BRIK™ Modules feature an electrically isolated package that simplifies system packaging, installation and cooling. POW-R-BRIK™ Modules utilize Compression Bonded Encapsulation (CBE) mounting and double side cooling of the semiconductor elements. The Z7A outline POW-R-BRIK™ uses 33mm or 38mm elements and the Z9A outline POW-R-BRIK™ uses 50mm elements. Standard circuit configurations include Dual SCR, Dual Diode, SCR/Diode, and Diode/SCR. Additional circuit configurations, e.g. Single Element, Common Cathode, Common Anode, and special element types, e.g. Fast Switch SCRs, Fast Recovery Diodes, GTOs, and Transistors are available.

Features:

- Electrically Isolated Packaging
- Anodized Aluminum Housing
- Internal Copper Contacting
- Gold Element Contacting
- Internal Temperature Sensor
- Compression Element Contacting

Applications:

- AC Motor Starters
- DC Motor Controls
- Resistance Welding Controls
- Mining Power Centers
- High Voltage Motor Starters
- Transportation Systems

POW-R-BRIK™
Phase Control Modules
 345-800 Amperes/400-3000 Volts

Configuration Reference:

The POW-R-BRIK™ part number system takes the form *P3 Z7A CT7 00 W16* where:

- *P3* is the configuration number. The configurations are shown pictorially in the right hand column.
- *Z7A* is the package type per the outline drawings *Z7A* and *Z9A* on this data sheet.
- *CT7* denotes the element code. The Element Code Reference at the end of this data sheet provides information on the standard element codes including the corresponding disc device using the element. Refer to the appropriate disc package data sheets in the Powerex Semiconductor Data Book for additional device specifications.
- *00* denotes special features:
 - 00 – module includes standard thermistor
 - XT – no thermistor
 - AA-ZZ – denotes unique customer specification
- *W16* denotes voltage code per the table below. Note that not all voltage ratings are available for every element. Refer to the Element Code Reference for available voltage ranges for a given element.

Elements	Voltage
Voltage Rating	Code
400	V04
600	V06
800	V08
1000	W10
1200	W12
1400	W14
1600	W16
1800	W18
2000	W20
2200	W22
2400	W24
2600	W26
2800	W28
3000	W30

Circuit Configurations:

P1 - DIODE
 P4 - FAST DIODE*

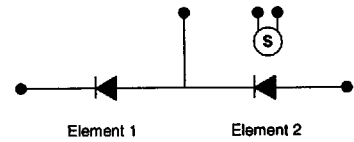

P2 - SCR/DIODE
 P5 - FAST SCR/FAST DIODE*

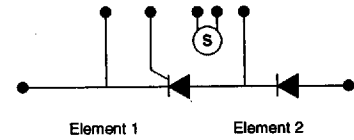

P3 - SCR/SCR
 P6 - FAST SCR/FAST SCR*

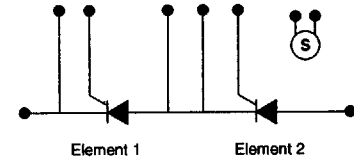

P7 - DIODE/SCR
 P8 - FAST DIODE/FAST SCR*

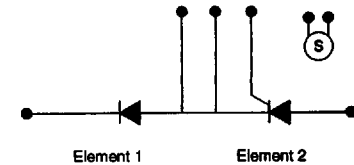

* Consult Factory for Available Ratings.

POW-R-BRIK™
Phase Control Modules
 345-800 Amperes/400-3000 Volts

Typical Thermistor Circuit

Thermistor temperatures can be measured using the following circuit arrangement in conjunction with a 5 volt source. Resistance values for R_1 and R_2 are specified for two operating temperature ranges.

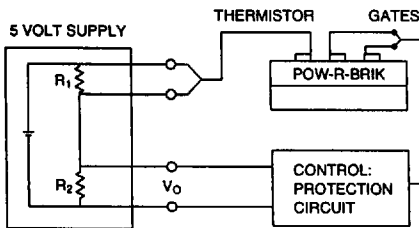

- Temperature range, 75°C through 125°C
 $R_1 = 3.5K$ ohms
 $R_2 = 840$ ohms
 $V_0 = 2.5$ volts at 100°C
- Temperature range, 90°C through 140°C
 $R_1 = 2.2K$ ohms
 $R_2 = 500$ ohms
 $V_0 = 2.45$ volts at 115°C

The output signal (V_0) is approximately 30 mv/°C over the temperature range indicated.

POW-R-BRIK™ Thermistor Characteristics

Thermistor Resistance Ohms	Thermistor Temp. °C	Element Average Temperature	
		Steady State °C (Min.)	Dynamic °C (Max.)
①	②	③	
12093	40	43	50
7337	50	53	60
4990	60	63	70
3324	70	73	80
2262	80	83	90
1569	90	93	100
1316	95	98	105
1109	100	103	110
938	105	108	115
797	110	113	120
680	115	118	125
582	120	123	130
500	125	128	135
431	130	133	140

- Curve matched ±2% over temperature range of +40°C to +125°C. Resistance tolerance specified at +125°C, ±6%.
- Without self heating, 10mW maximum thermistor dissipation.
- Use "Sensor at T_1 " ohms from characteristics for recommended steady state overload trip resistance.

TRANSIENT THERMAL IMPEDANCE CHARACTERISTICS (JUNCTION-TO-CASE) Z7A

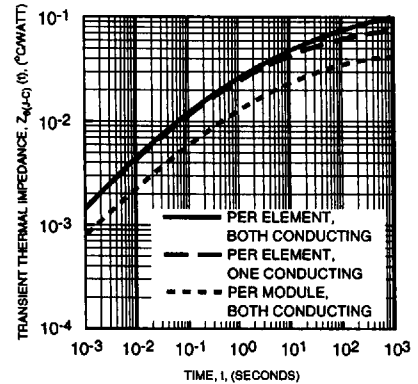

TRANSIENT THERMAL IMPEDANCE CHARACTERISTICS (JUNCTION-TO-CASE) Z9A

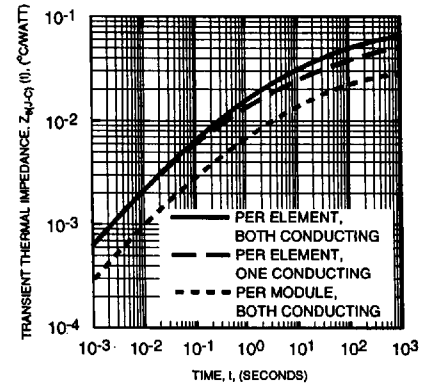



Powerex, Inc., 200 Hillis Street, Youngwood, Pennsylvania 15697-1800 (412) 925-7272

POW-R-BRIK™
Phase Control Modules
345-800 Amperes/400-3000 Volts

Maximum Ratings and Electrical Characteristics

Part Number	Voltage Gate Current, Speed of Element*												Isolation Voltage**		Strike Distance		
	Voltage					Gate		Current				Speed					
	V _{DRM} /V _{RRM} ^①		V _{RSM}		dv/dt ^②	V _{GT}	I _{GT}	di/dt ^③	I _{DRM} /I _{RRM} ^①		I _{TSM} /I _{FSM} ^⑤		SCR Diode		V _{RMS}	I _{RMS}	Terminals to Case
E1 (V)	E2 (V)	E1 (V)	E2 (V)	(V/μs)	(V)	(mA)	(A/μs)	E1 (mA)	E2 (mA)	E1 (kA)	E2 (kA)	t _q (μs)	t _r (μs)	(V)	(mA)	(In.)	(In.)

Diode/Diode

P1Z7AAR700W__	3000	3000	3100	3100	—	—	—	—	50	50	7	7	—	15	3000	1.10	0.70	1.00
P1Z7ABR700W__	2200	2200	2300	2300	—	—	—	—	50	50	9	9	—	10	2500	0.92	0.70	1.00
P1Z9AAR900W__	3000	3000	3100	3100	—	—	—	—	150	150	16	16	—	20	3000	1.70	1.00	1.15
P1Z9ACR900W__	1200	1200	1300	1300	—	—	—	—	150	150	30	30	—	15	2500	1.50	1.00	1.15
P1Z9ADR900V__	600	600	700	700	—	—	—	—	150	150	50	50	—	10	2500	1.50	1.00	1.15

Half Control SCR/Rectifier^①

P2Z7ABB700W__	2200	2200	2300	2300	300	3	150	600	30	30	9	9	150	10	2500	0.92	0.70	1.00
P2Z7ACB700W__	1600	1600	1700	1700	300	3	150	600	30	30	10	14	150	8	2500	0.92	0.70	1.00
P2Z9AAA900W__	3000	3000	3100	3100	300	3	200	600	150	150	15	16	400	20	3000	1.70	1.00	1.15
P2Z9ABA900W__	2200	2200	2100	2100	300	3	200	600	75	75	17	16	250	20	2500	1.50	1.00	1.15
P2Z9ACA900W__	1600	1600	1700	1700	300	3	200	600	75	75	25	16	150	20	2500	1.50	1.00	1.15

Full Control SCR/SCR

P3Z7ABT700W__	2200	2200	2300	2300	300	3	150	600	30	30	9	9	150	—	2500	0.92	0.70	1.00
P3Z7ACT700W__	1600	1600	1700	1700	300	3	150	600	30	30	10	10	150	—	2500	0.92	0.70	1.00
P3Z7AAT800W__	3000	3000	3100	3100	300	3	150	600	35	35	9	9	200	—	2500	0.92	0.70	1.00
P3Z7ABT800W__	2200	2200	2300	2300	300	3	150	600	35	35	12	12	200	—	2500	0.92	0.70	1.00
P3Z7ACT800W__	1400	1400	1500	1500	300	3	150	600	35	35	15	15	200	—	2500	0.92	0.70	1.00
P3Z9AAT900W__	3000	3000	3100	3100	300	3	200	600	150	150	15	15	400	—	3000	1.70	1.00	1.15
P3Z9ABT900W__	2200	2200	2100	2100	300	3	200	600	75	75	17	17	250	—	2500	1.50	1.00	1.15
P3Z9ACT900W__	1600	1600	1700	1700	300	3	200	600	75	75	25	25	150	—	2500	1.50	1.00	1.15

Half Control Rectifier/SCR^⑧

P7Z7ABB700W__	2200	2200	2300	2300	300	3	150	600	30	30	9	9	150	10	2500	0.92	0.70	1.00
P7Z7ABC700W__	1600	1600	1700	1700	300	3	150	600	30	30	14	10	150	8	2500	0.92	0.70	1.00
P7Z9AAA900W__	3000	3000	3100	3100	300	3	200	600	150	150	16	15	400	20	3000	1.70	1.00	1.15
P7Z9AAB900W__	2200	2200	2100	2100	300	3	200	600	75	75	16	17	250	20	2500	1.50	1.00	1.15
P7Z9AAC900W__	1600	1600	1700	1700	300	3	200	600	75	75	16	25	150	20	2500	1.50	1.00	1.15

- ① Applies for zero or negative gate bias.
- ② Higher dv/dt ratings available, consult factory.
- ③ With recommended gate drive.
- ④ Per JEDEC standard RS-397, 5.2.2.8.
- ⑤ Per JEDEC RS-397, 5.2.2.1.
- ⑥ Bottom side cooled.
- ⑦ Consult recommended mounting procedures.
- ⑧ Designs are available for "Current Source Inverter" applications, consult factory.
- ⑨ Reflects substantial derating necessary with single 0.08°C/W or 0.10°C/W sink.
- * Element location indicated by E1 or E2.
- ** Hi-Pot. 60Hz, 1 min. test



Powerex, Inc., 200 Hillis Street, Youngwood, Pennsylvania 15697-1800 (412) 925-7272

POW-R-BRIK™
Phase Control Modules
 345-800 Amperes/400-3000 Volts

Part Number	Current and Thermal Ratings of Module								Circuit Currents				Element Data Model*		
	Current			Thermal					Units per Sink →	1 AC Switch	3 AC Switch ^③	2 1Ø Bridge	3 3Ø Bridge ^④	E1	E2
	I _{T(av)} ^① @T _C (A)	Maximum Power Dissipation (W)	T _j (°C)	Sensor @T _j (Ω)	R _{θ(J-C)} per Module (°C/W)	R _{θ(C-S)} per Module ^⑦ (°C/W)	R _{θ(C-A)} (°C/W)	T _A (°C)							

Diode/Diode

P1Z7AAR700W__	355	105	1125	150	315	0.04	0.010	0.10	40	—	—	385	400	AR7	AR7
P1Z7ABR700W__	435	105	1125	150	315	0.04	0.010	0.10	40	—	—	440	465	BR7	BR7
P1Z9AAR900W__	590	105	1500	150	315	0.03	0.008	0.08	40	—	—	570	600	AR9	AR9
P1Z9ACR900W__	740	105	1500	150	315	0.03	0.008	0.08	40	—	—	670	705	CR9	CR9
P1Z9ADR900V__	800	110	1330	150	315	0.03	0.008	0.08	40	—	—	775	805	DR9	DR9

Half Control SCR/Diode^⑧

P2Z7ABB700W__	380	85	1100	130	530	0.04	0.010	0.10	40	560	275	330	350	BT7	BR7
P2Z7ACB700W__	395	85	1100	130	530	0.04	0.010	0.10	40	590	290	345	365	CT7	BR7
P2Z9AAA900W__	430	85	1325	125	640	0.03	0.008	0.08	40	630	310	370	390	AT9	AR9
P2Z9ABA900W__	520	85	1465	130	530	0.03	0.008	0.08	40	740	365	435	460	BT9	AR9
P2Z9ACA900W__	590	85	1465	130	530	0.03	0.008	0.08	40	800	385	470	495	CT9	AR9

Full Control SCR/SCR

P3Z7ABT700W__	345	85	1095	130	530	0.04	0.010	0.10	40	505	250	300	315	BT7	BT7
P3Z7ACT700W__	375	85	1095	130	530	0.04	0.010	0.10	40	550	270	320	335	CT7	CT7
P3Z7AAT800W__	300	85	1095	130	530	0.04	0.010	0.10	40	445	220	255	265	AT8	AT8
P3Z7ABT800W__	390	85	1095	130	530	0.04	0.010	0.10	40	560	275	330	345	BT8	BT8
P3Z7ACT800W__	450	85	1095	130	530	0.04	0.010	0.10	40	630	300	385	405	CT8	CT8
P3Z9AAT900W__	355	85	1295	125	640	0.03	0.008	0.08	40	535	260	310	330	AT9	AT9
P3Z9ABT900W__	470	85	1460	130	530	0.03	0.008	0.08	40	675	335	400	420	BT9	BT9
P3Z9ACT900W__	600	85	1460	130	530	0.03	0.008	0.08	40	815	375	460	480	CT9	CT9

Half Control SCR/Diode^⑧

P7Z7ABB700W__	380	85	1100	130	530	0.04	0.010	0.10	40	560	275	330	350	BR7	BT7
P7Z7ABC700W__	395	85	1100	130	530	0.04	0.010	0.10	40	590	290	345	365	BR7	CT7
P7Z9AAA900W__	430	85	1325	125	640	0.03	0.008	0.08	40	630	310	370	390	AR9	AT9
P7Z9AAB900W__	520	85	1465	130	530	0.03	0.008	0.08	40	740	365	435	460	AR9	BT9
P7Z9AAC900W__	590	85	1465	130	530	0.03	0.008	0.08	40	800	385	470	495	AR9	CT9

- ① Applies for zero or negative gate bias.
- ② Higher dv/dt ratings available, consult factory.
- ③ With recommended gate drive.
- ④ Per JEDEC standard RS-397, 5.2.2.6.
- ⑤ Per JEDEC RS-397, 5.2.2.1.
- ⑥ Bottom side cooled.
- ⑦ Consult recommended mounting procedures.
- ⑧ Designs are available for "Current Source Inverter" applications, consult factory.
- ⑨ Reflects substantial derating necessary with single 0.08°C/W or 0.10°C/W sink.
- * Reference element data model on the following page.



Powerex, Inc., 200 Hillis Street, Youngwood, Pennsylvania 15697-1800 (412) 925-7272

POW-R-BRIK™
 Phase Control Modules
 345-800 Amperes/400-3000 Volts

Element Code Reference

Element Code	Element Type	Comparable Disc Device	Available Voltage Range	Coefficients for V_{TM} , V_F , Model ^{① ②}			
				A	B	C	D
AR7	33mm Diode	R7S0 __ 08XX00	2200-3000	0.89605	-0.08108	0.00045	0.02836
BR7	33mm Diode	R7S0 __ 12XX00	1200-2200	0.63200	-0.02192	0.00013	0.02065
CR7 ^③	33mm Diode	R7S0 __ 16XX00	800-1200	0.45000	0.02800	0.00008	0.01128
AR9	50mm Diode	R9G0 __ 12XX00	2200-3000	0.39964	0.05540	0.00024	0.00319
CR9	50mm Diode	R9G0 __ 18XX00	800-1200	0.60627	-0.00168	0.00005	0.00766
DR9	50mm Diode	R9G0 __ 22XX00	400-800	0.46319	0.02950	0.00006	0.00061
BT7	33mm SCR	T7S0 __ 6504DN	1400-2200	0.74419	0.00380	0.000325	0.01882
CT7	33mm SCR	T7S0 __ 7504DN	800-1600	0.58729	0.06654	0.000416	0.00060
AT8	38mm SCR	T820 __ 6003DH	2200-3000	1.02841	0.13475	0.001179	-0.03631
BT8	38mm SCR	T820 __ 7503DH	1200-2200	0.88287	-0.07743	0.00010	0.03081
CT8	38mm SCR	T820 __ 9003DH	800-1400	1.08412	-0.13881	-0.00013	0.03756
AT9	50mm SCR	T9G0 __ 0803DH	2200-3000	1.43303	-0.10092	0.000620	0.01789
BT9	50mm SCR	T9G0 __ 1003DH	1200-2200	0.96195	-0.08755	0.000074	0.03286
CT9	50mm SCR	T9G0 __ 1203DH	800-1600	0.55570	0.05740	0.000135	0.00104
9HP ^③	50mm SCR	T9GH __ 0903DH	1200-2200	0.95642	-0.00285	0.000225	-0.00178

① V_{TM} , $V_F = A + B \times \ln(I) + C \times I + D \times \sqrt{I}$ (I = Amps Peak)

② Coefficients are for $T_j = 130^\circ\text{C}$, 50A through 3000A Peak

③ Module ratings for these elements are not shown, consult factory.



Powerex, Inc., Hillis Street, Youngwood, Pennsylvania 15697 (412) 925-7272
 Powerex Europe, S.A., 428 Avenue G. Durand, BP107, 72003 Le Mans, France (43) 41.14.14

Taping

STANDARD SPECIFICATIONS FOR TAPING OF MOLDED PACKAGE THYRISTORS AND TRIACS

TO-92 Package

Thyristor
CR02AM, CR03AM, CR04AM
Triac
BCR1AM

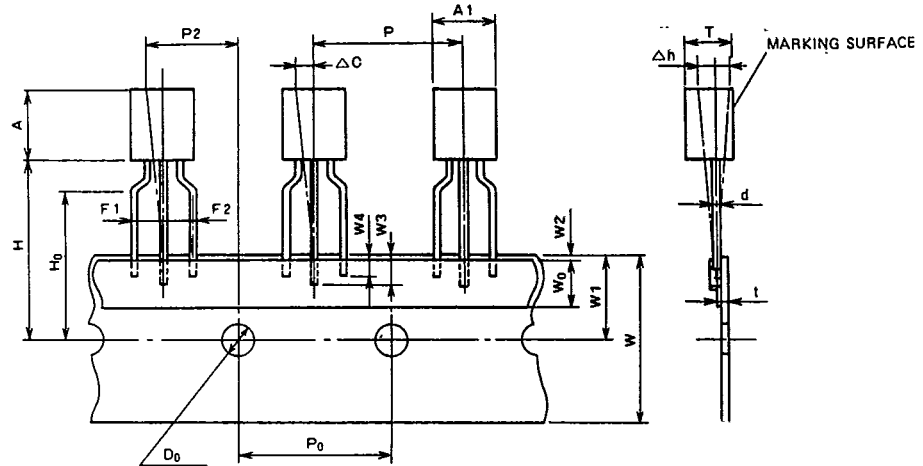

Taping dimensions

Description of symbol	Symbol	Dimensions (Unit:mm)	Remark
Product width	A1	5.0 MAX	
Product height	A	5.0 MAX	
Product thickness	T	3.7 MAX	
Lead wire diameter	d	0.6 MAX	
Sticker lead wire length (1)	W3	2.5 MIN	
Sticker lead wire length (2)	W4	2.0 MIN	
Pitch between products	P	12.7 ± 1.0	
Feed hole pitch	P ₀	12.7 ± 0.3	The cumulative pitch error is ± 1mm per 20 pitches.
Feed hole deviation (1)	P2	6.35 ± 1.3	
Distance between lead wires	F1, F2	2.5 ± 0.4	
Defective product (1)	Δh	0 ± 2.0	
Tape width	W	18.0 ± $\begin{smallmatrix} 1.0 \\ 0.5 \end{smallmatrix}$	
Sticker tape width	W ₀	6.0 ± 0.5	
Feed hole deviation (2)	W1	9.0 ± 0.5	
Sticker tape deviation	W2	0.5 MAX	
Position of product bottom surface	H	17.5 MIN	
Lynch height of lead wire	H ₀	16.0 ± 0.5	
Feed hole diameter	D ₀	4.0 ± 0.2	
Tape thickness	t	0.7 ± 0.2	
Defective product (2)	ΔC	0 ± 1.0	



Powerex, Inc., Hills Street, Youngwood, Pennsylvania 15697 (412) 925-7272
 Powerex Europe, S.A., 428 Avenue G. Durand, BP107, 72003 Le Mans, France (43) 41.14.14

Powerex Semiconductor Data Book
 Taping

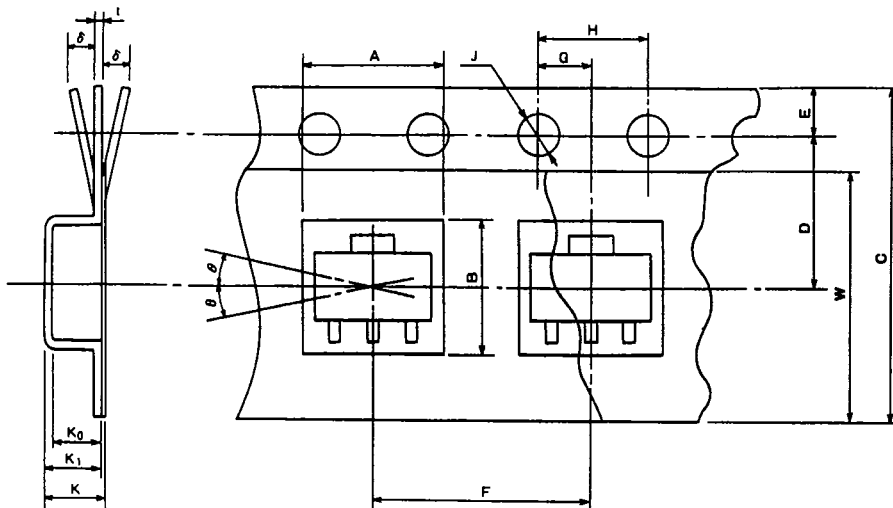

SOT-89 Package

Thyristor
 CR08AS

Taping dimensions

Description of symbol		Symbol	Dimensions/angles Unit:mm	Remark
Parts Insertion	Height	A	5.0 ± 0.1	Cross-section of the surface 0.5mm above the Inner bottom
	Width	B	4.6 ± 0.1	Cross-section of the surface 0.5mm above the inner bottom
Concave square hole	Depth	K ₀	1.8 ± 0.1	Inner space
	Pitch	F	8.0 ± 0.1	Cumulative error +0.1/-0.3 MAX/10 pitches
Round feed hole	Diameter	J	$\phi 1.5 \pm 0.05$	
	Pitch	H	4.0 ± 0.1	Cumulative error +0.1/-0.3 MAX/10 pitches
	Position	E	1.5 ± 0.1	Distance between the tape edge and the hole center
Distance between center lines	Vertical	G	2.0 ± 0.5	Center line of concave square hole and round feed hole
	Horizontal	D	5.65 ± 0.05	Center line of concave square hole and round feed hole
Cover tape	Width	W	$9.5 + 0.3/-0$	Thickness: 0.1 MAX
Carrier tape	Width	C	12 ± 0.2	Warp ± 0.3 MAX
	Thickness	t	0.3 ± 0.05	
	Package hole depth	K ₁	2.1 ± 0.1	
Device	Package dimensions	—	—	As shown in (e)
	Inclination	θ	30° MAX.	
Total Thickness		K	2.3 ± 0.1	Total thickness including cover and carrier tapes