

**N-Channel Enhancement-Mode MOSFET**

$V_{DS}$  30V  $R_{DS(ON)}$  8mΩ  $I_D$  70A

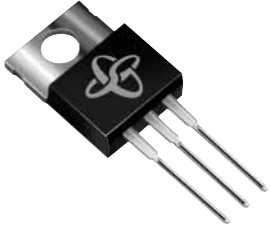

**TRENCH GENFET®**

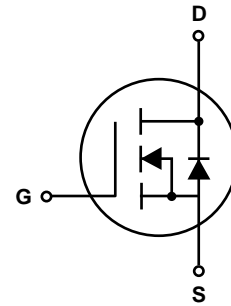

**TO-220AB**

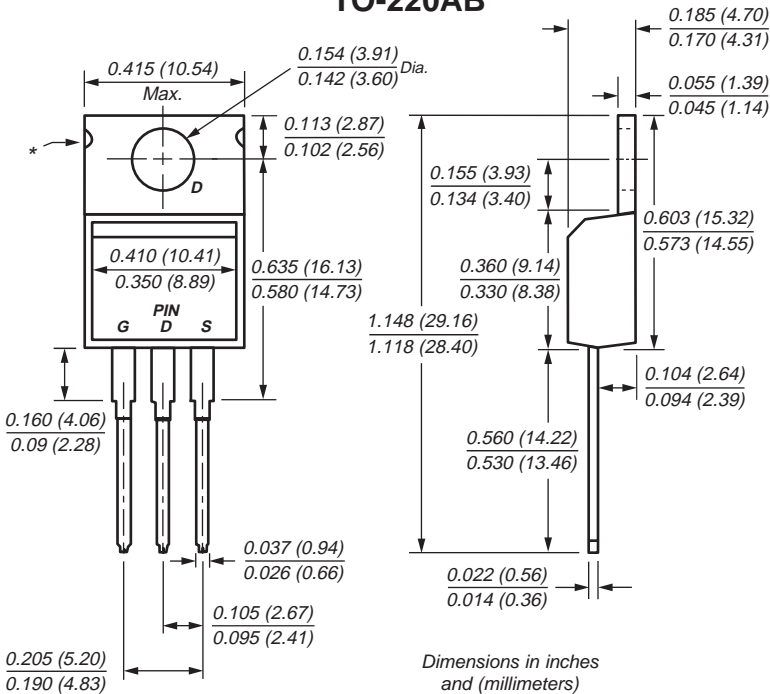

**Features**

- Advanced Process Technology
- High Density Cell Design for Ultra Low On-Resistance
- Specially Designed for Low Voltage DC/DC Converters
- Fast Switching for High Efficiency

**Mechanical Data**

**Case:** JEDEC TO-220AB molded plastic body

**Terminals:** Leads solderable per MIL-STD-750, Method 2026

**High temperature soldering guaranteed:** 250°C/10 seconds, 0.17" (4.3mm) from case

**Mounting Torque:** 10 in-lbs maximum

**Weight:** 2.0g

\* May be notched or flat

**Maximum Ratings and Thermal Characteristics** ( $T_C = 25^\circ\text{C}$  unless otherwise noted)

Parameter	Symbol	Limit	Unit
Drain-Source Voltage	$V_{DS}$	30	V
Gate-Source Voltage	$V_{GS}$	±20	
Continuous Drain Current <sup>(1)</sup>	$I_D$	70	A
Pulsed Drain Current	$I_{DM}$	200	
Maximum Power Dissipation	$P_D$	$T_C = 25^\circ\text{C}$ 25 $T_C = 100^\circ\text{C}$	W
Operating Junction and Storage Temperature Range	$T_J, T_{stg}$	-55 to 150	°C
Lead Temperature (1/8" from case for 5 sec.)	$T_L$	275	°C
Junction-to-Case Thermal Resistance	$R_{\theta JC}$	2.0	°C/W
Junction-to-Ambient Thermal Resistance	$R_{\theta JA}$	62.5	°C/W

**Notes:** (1) Maximum DC current limited by the package

**N-Channel Enhancement-Mode MOSFET**

**Electrical Characteristics** (T<sub>J</sub> = 25°C unless otherwise noted)

Parameter	Symbol	Test Condition	Min	Typ	Max	Unit
<b>Static</b>						
Drain-Source Breakdown Voltage	BV <sub>DSS</sub>	V <sub>GS</sub> = 0V, I <sub>D</sub> = 250μA	30	—	—	V
Gate Threshold Voltage	V <sub>GS(th)</sub>	V <sub>DS</sub> = V <sub>GS</sub> , I <sub>D</sub> = 250μA	1.0	—	3.0	V
Gate-Body Leakage	I <sub>GSS</sub>	V <sub>DS</sub> = 0V, V <sub>GS</sub> = ±20V	—	—	±100	nA
Zero Gate Voltage Drain Current	I <sub>DSS</sub>	V <sub>DS</sub> = 30V, V <sub>GS</sub> = 0V	—	—	1	μA
On-State Drain Current <sup>(2)</sup>	I <sub>D(on)</sub>	V <sub>DS</sub> ≥ 5V, V <sub>GS</sub> = 10V	70	—	—	A
Drain-Source On-State Resistance <sup>(2)</sup>	R <sub>DSON</sub>	V <sub>GS</sub> = 10V, I <sub>D</sub> = 35A	—	6	8	mΩ
		V <sub>GS</sub> = 4.5V, I <sub>D</sub> = 30A	—	9	11	
Forward Transconductance <sup>(2)</sup>	g <sub>fs</sub>	V <sub>DS</sub> = 15V, I <sub>D</sub> = 35A	—	61	—	S
<b>Dynamic</b>						
Total Gate Charge	Q <sub>g</sub>	V <sub>DS</sub> = 15V, V <sub>GS</sub> = 5V, I <sub>D</sub> = 35A	—	34	48	nC
Gate-Source Charge	Q <sub>gs</sub>	V <sub>DS</sub> = 15V, V <sub>GS</sub> = 10V I <sub>D</sub> = 35A	—	63	95	
Gate-Drain Charge	Q <sub>gd</sub>		—	11	—	
Turn-On Delay Time	t <sub>d(on)</sub>	V <sub>DD</sub> = 15V, R <sub>L</sub> = 15Ω I <sub>D</sub> ≅ 1A, V <sub>GEN</sub> = 10V R <sub>G</sub> = 6Ω	—	9	14	ns
Rise Time	t <sub>r</sub>		—	9	14	
Turn-Off Delay Time	t <sub>d(off)</sub>		—	100	167	
Fall Time	t <sub>f</sub>		—	31	62	
Input Capacitance	C <sub>iss</sub>	V <sub>GS</sub> = 0V	—	3400	—	pF
Output Capacitance	C <sub>oss</sub>	V <sub>DS</sub> = 15V	—	618	—	
Reverse Transfer Capacitance	C <sub>rss</sub>	f = 1.0MHz	—	300	—	
<b>Source-Drain Diode</b>						
Max Diode Forward Current	I <sub>S</sub>	—	—	—	35	A
Diode Forward Voltage <sup>(2)</sup>	V <sub>SD</sub>	I <sub>S</sub> = 35A, V <sub>GS</sub> = 0V	—	0.9	1.3	V

**Notes:**

(1) Maximum DC current limited by the package

(2) Pulse test; pulse width ≤ 300 μs, duty cycle ≤ 2%

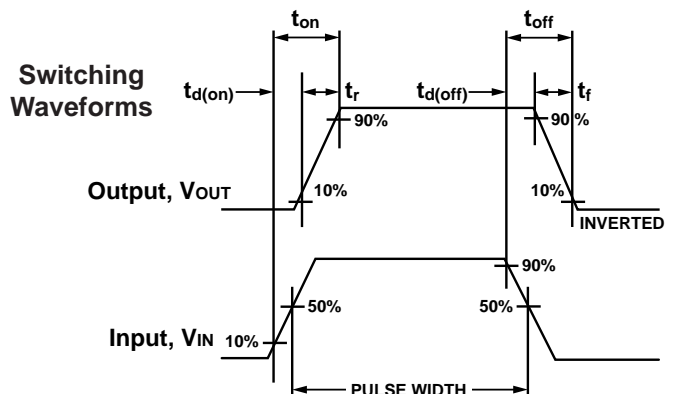
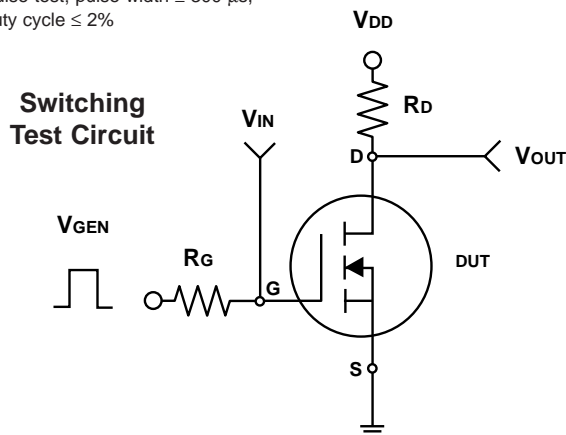

N-Channel Enhancement-Mode MOSFET

Ratings and Characteristic Curves (T<sub>A</sub> = 25°C unless otherwise noted)

Fig. 1 – Output Characteristics

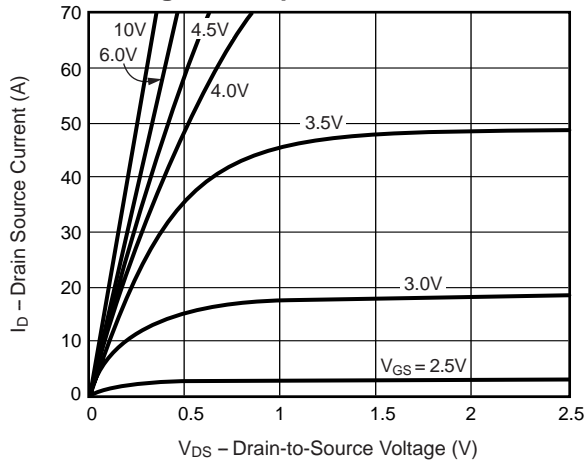

Fig. 2 – Transfer Characteristics

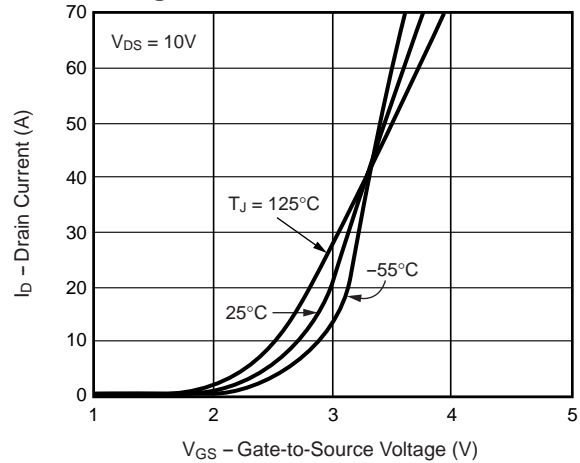

Fig. 3 – Threshold Voltage vs. Temperature

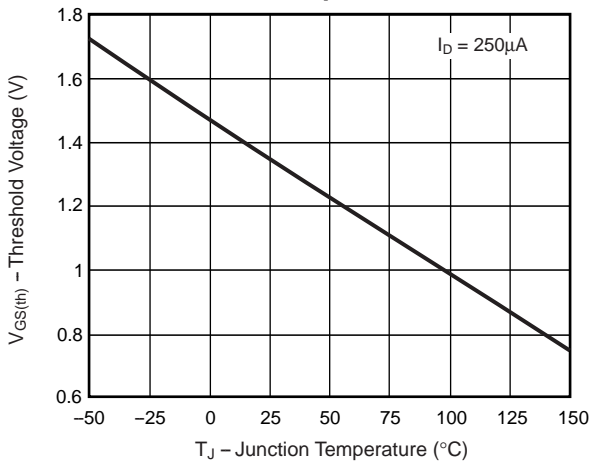

Fig. 4 – On-Resistance vs. Drain Current

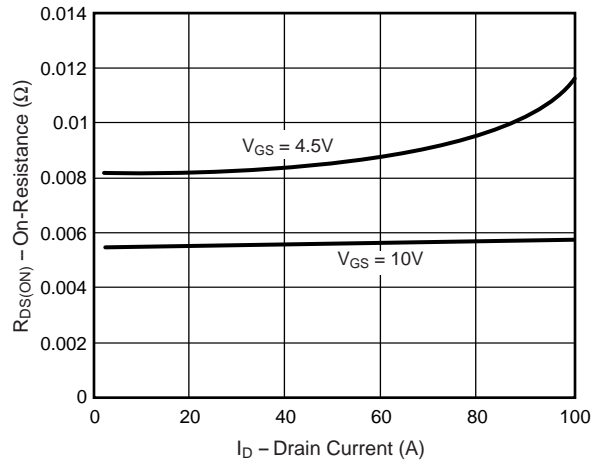
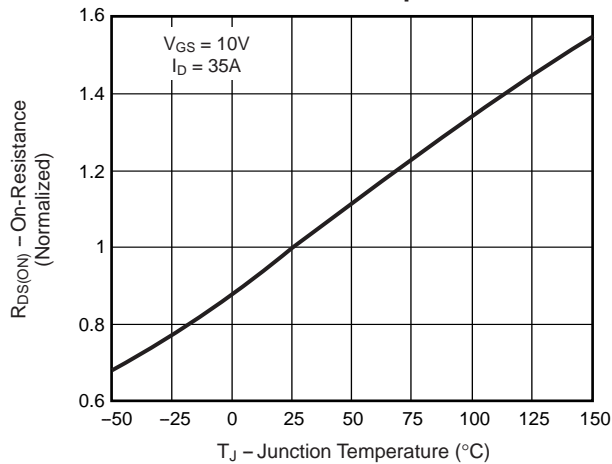

Fig. 5 – On-Resistance vs. Junction Temperature



N-Channel Enhancement-Mode MOSFET

Ratings and Characteristic Curves (T<sub>A</sub> = 25°C unless otherwise noted)

Fig. 6 – On-Resistance vs. Gate-to-Source Voltage

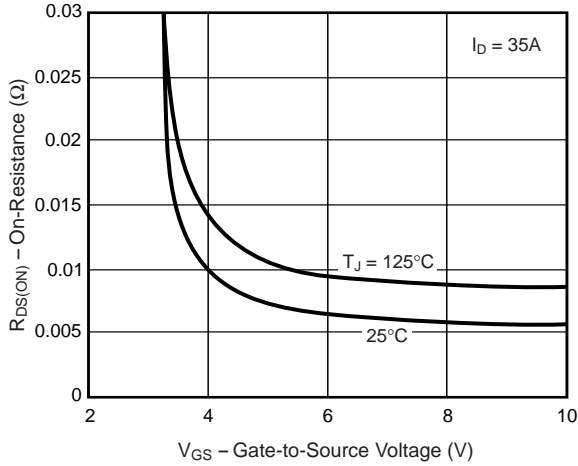

Fig. 7 – Gate Charge

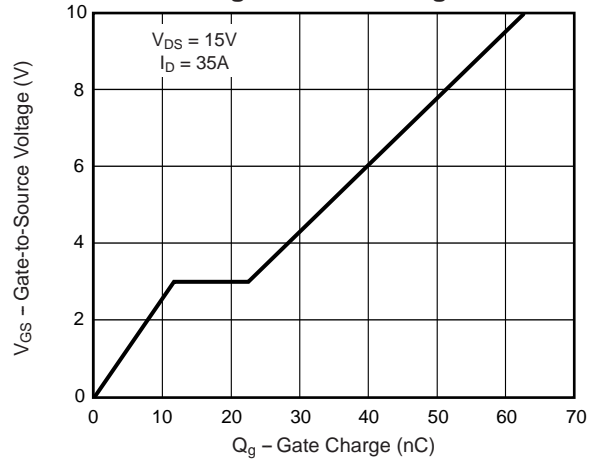

Fig. 8 – Capacitance

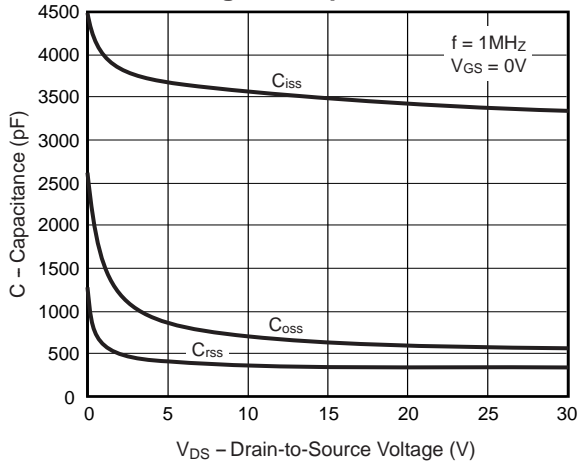
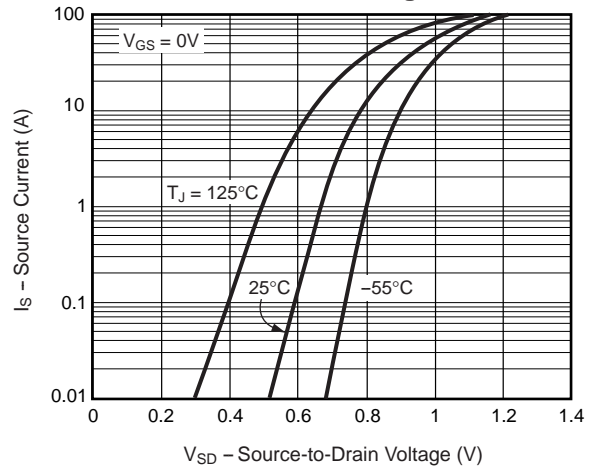

Fig. 9 – Source-Drain Diode Forward Voltage



**N-Channel Enhancement-Mode MOSFET**

**Ratings and Characteristic Curves** ( $T_A = 25^\circ\text{C}$  unless otherwise noted)

**Fig. 10 – Breakdown Voltage vs. Junction Temperature**

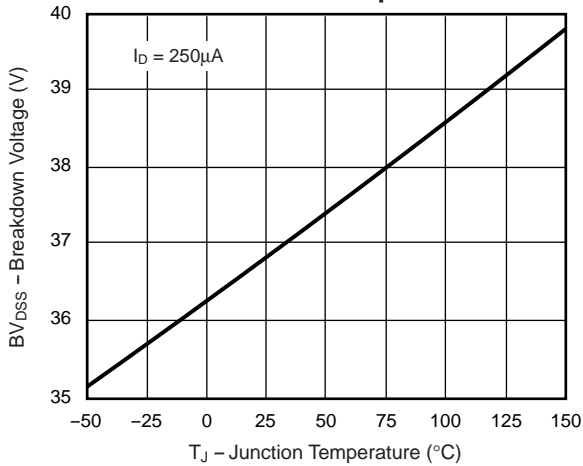

**Fig. 11 – Thermal Impedance**

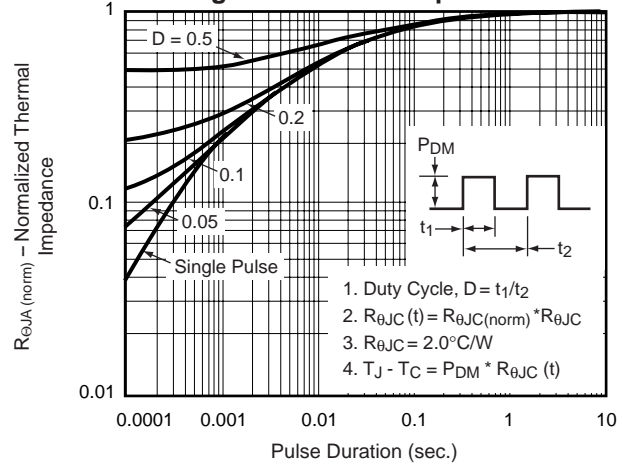

**Fig. 12 – Power vs. Pulse Duration**

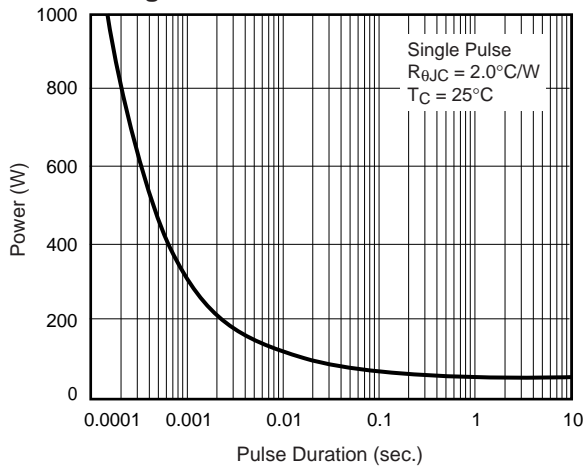

**Fig. 13 – Maximum Safe Operating Area**

