

# 500mA Low Dropout Linear Regulator

## FEATURES

- Low Dropout Voltage of 650mV at 500mA Output Current (3V Output Version).
- Guaranteed 500mA Output Current.
- Maximum Input Voltage is 8V
- Low Ground Current at 65 $\mu$ A.
- 2% Accuracy Output Voltage of 1.5V/1.8V/ 2.0V /2.5V /2.7V/ 3.0V/ 3.3V/ 3.5V/ 3.7V/ 3.8V/ 5.0V/ 5.2V.
- Only needs 4.7 $\mu$ F Output Capacitor for Stability.
- Current and Thermal Limiting.

## APPLICATIONS

- CD-ROM Drivers.
- LAN Cards.
- Microprocessor.
- RAM Module.
- Wireless Communication Systems.
- Battery Powered Systems.

## DESCRIPTION

The AIC1723A is a 3-pin low dropout linear regulator. The superior characteristics of the AIC1723A include zero base current loss, very low dropout voltage, and 2% accuracy output voltage. Typical ground current remains approximately 65  $\mu$  A, for loading ranging from zero to maximum. Dropout voltage turns substantially low when output current is 500mA. Built-in output current limiting and thermal limiting provide maximal protection to the AIC1723A against fault conditions.

The AIC1723A is available with popular SOT-23, SOT-223, SOT-89 and TO-252 packages.

## TYPICAL APPLICATION CIRCUIT

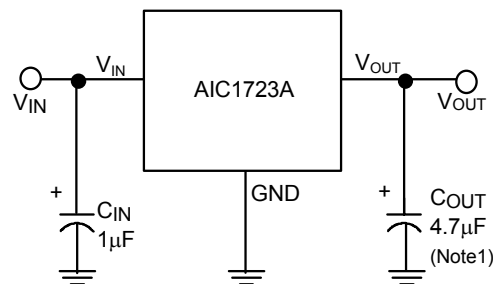

Low Dropout Linear Regulator

## ORDERING INFORMATION

AIC1723A-XXXX XX

PACKING TYPE  
TR: TAPE & REEL  
TB: TUBE

PACKAGE TYPE  
E: TO-252  
U: SOT-23  
X: SOT-89  
Y: SOT-223

C: Commercial  
P: Lead Free Commercial  
G: Green Package  
(Only for TO-252,  
SOT-89 & SOT-223)

OUTPUT VOLTAGE  
15: 1.5V  
18: 1.8V  
20: 2.0V  
25: 2.5V  
27: 2.7V  
30: 3.0V  
33: 3.3V  
35: 3.5V  
37: 3.7V  
38: 3.8V  
50: 5.0V  
52: 5.2V

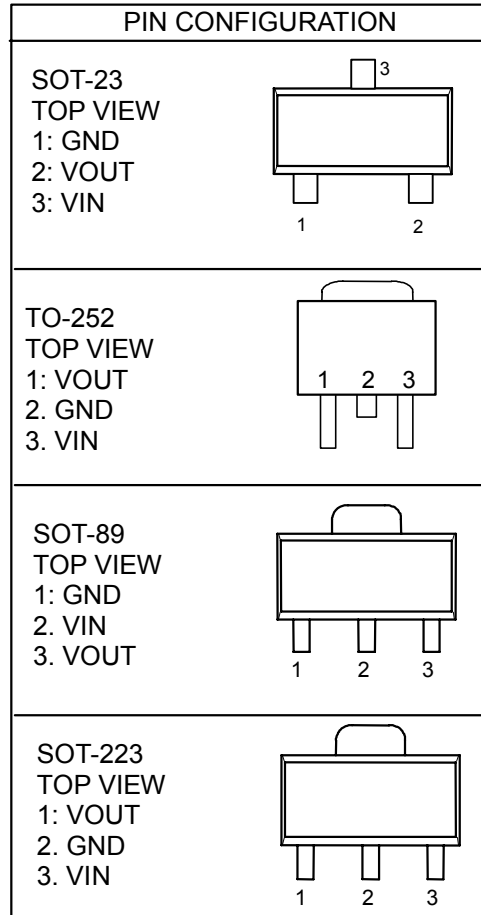

Example: AIC1723A-18CETR

→ 1.8V Version, in TO-252 Package & Tape & Reel Packing Type

AIC1723A-18PYTR

→ 1.8V Version, in SOT-223 Lead Free Package & Tape & Reel Packing Type

### SOT-23 MARKING

Part No.	CU	PU	Part No.	CU	PU
AIC1723A-15XU	BT15	BT15P	AIC1723A-33XU	BT33	BT33P
AIC1723A-18XU	BT18	BT18P	AIC1723A-35XU	BT35	BT35P
AIC1723A-20XU	BT20	BT20P	AIC1723A-37XU	BT37	BT37P
AIC1723A-25XU	BT25	BT25P	AIC1723A-38XU	BT38	BT38P
AIC1723A-27XU	BT27	BT27P	AIC1723A-50XU	BT50	BT50P
AIC1723A-30XU	BT30	BT30P	AIC1723A-52XU	BT52	BT52P

**● SOT-89 MARKING**

Part No.	CX	PX	GX	Part No.	CX	PX	GX
AIC1723A-15XX	AV15	AV15P	AV15G	AIC1723A-33XX	AV33	AV33P	AV33G
AIC1723A-18XX	AV18	AV18P	AV18G	AIC1723A-35XX	AV35	AV35P	AV35G
AIC1723A-20XX	AV20	AV20P	AV20G	AIC1723A-37XX	AV37	AV37P	AV37G
AIC1723A-25XX	AV25	AV25P	AV25G	AIC1723A-38XX	AV38	AV38P	AV38G
AIC1723A-27XX	AV27	AV27P	AV27G	AIC1723A-50XX	AV50	AV50P	AV50G
AIC1723A-30XX	AV30	AV30P	AV30G	AIC1723A-52XX	AV52	AV52P	AV52G

**● SOT-223 MARKING**

Part No.	CY	PY	GY	Part No.	CY	PY	GY
AIC1723A-15XY	BU15	BU15P	BU15G	AIC1723A-33XY	BU33	BU33P	BU33G
AIC1723A-18XY	BU18	BU18P	BU18G	AIC1723A-35XY	BU35	BU35P	BU35G
AIC1723A-20XY	BU20	BU20P	BU20G	AIC1723A-37XY	BU37	BU37P	BU37G
AIC1723A-25XY	BU25	BU25P	BU25G	AIC1723A-38XY	BU38	BU38P	BU38G
AIC1723A-27XY	BU27	BU27P	BU27G	AIC1723A-50XY	BU50	BU50P	BU50G
AIC1723A-30XY	BU30	BU30P	BU30G	AIC1723A-52XY	BU52	BU52P	BU52G

**■ ABSOLUTE MAXIMUM RATINGS**

Input Supply Voltage .....	-0.3~8V	
Operating Temperature Range .....	-40°C~ 85°C	
Junction Temperature .....	125°C	
Storage Temperature Range .....	-65°C~150°C	
Lead Temperature (Soldering, 10sec) .....	260°C	
Thermal Resistance Junction to Case	SOT-23 Package .....	130°C/W
	TO-252 Package .....	12.5°C/W
	SOT-89 Package .....	30°C/W
	SOT-223 Package .....	15°C/W
Thermal Resistance Junction to Ambient	SOT-23 Package .....	180°C/W
(Assume no Ambient Airflow, no Heatsink)	TO-252 Package .....	100°C/W
	SOT-89 Package .....	160°C/W
	SOT-223 Package .....	130°C/W

**Absolute Maximum Rating** are those value beyond which the life of a device may be impaired.

**■ TEST CIRCUIT**

Refer to the TYPICAL APPLICATION CIRCUIT

■ **ELECTRICAL CHARACTERISTICS** ( $T_A=25^{\circ}\text{C}$ ,  $C_{IN}=1\mu\text{F}$ ,  $C_{OUT}=4.7\mu\text{F}$ , unless otherwise specified.) (Note 2)

PARAMETER	TEST CONDITIONS	MIN.	TYP.	MAX.	UNIT
Output Voltage	$V_{IN}=8\text{V}$ , No Load	-2		+2	%
Line Regulation	$I_L=1\text{mA}$ , $1.8\text{V}\leq V_{OUT}\leq 3.2\text{V}$		3	10	mV
	$3.3\text{V}\leq V_{OUT}\leq 5.2\text{V}$	$V_{IN}=4\text{V}\sim 8\text{V}$ $V_{IN}=5.5\text{V}\sim 8\text{V}$	3	15	
Load Regulation (Note 3)	$I_L=0.1\sim 500\text{mA}$ $1.8\text{V}\leq V_{OUT}\leq 3.9\text{V}$		10	30	mV
	$4.0\text{V}\leq V_{OUT}\leq 5.2\text{V}$	$V_{IN}=5\text{V}$ $V_{IN}=7\text{V}$	20	50	
Current Limit (Note 4)	$V_{IN}=7\text{V}$ , $V_{OUT}=0\text{V}$	500			mA
Dropout Voltage (Note 5)	$I_L=500\text{mA}$	$4.0\text{V}\leq V_{OUT}\leq 5.2\text{V}$	510	710	mV
		$3.0\text{V}\leq V_{OUT}\leq 3.9\text{V}$	650	850	
		$2.5\text{V}\leq V_{OUT}\leq 2.9\text{V}$	780	980	
		$2.0\text{V}\leq V_{OUT}\leq 2.4\text{V}$	1100	1300	
		$1.8\text{V}\leq V_{OUT}\leq 1.9\text{V}$	1400	1600	
Ground Current	$I_O=0.1\text{mA}\sim I_{MAX}$ $1.8\text{V}\leq V_{OUT}\leq 3.9\text{V}$		65	90	$\mu\text{A}$
	$4.0\text{V}\leq V_{OUT}\leq 5.2\text{V}$	$V_{IN}=5\sim 8\text{V}$ $V_{IN}=7\sim 8\text{V}$	65	90	
Thermal Shutdown Hysteresis	Guaranteed by design		20		$^{\circ}\text{C}$

Note 1: To avoid output oscillation, aluminum electrolytic output capacitor is recommended and ceramic capacitor is not suggested.

Note 2: Specifications are production tested at  $T_A=25^{\circ}\text{C}$ . Specifications over the  $-40^{\circ}\text{C}$  to  $85^{\circ}\text{C}$  operating temperature range are assured by design, characterization and correlation with Statistical Quality Controls (SQC).

Note 3: Regulation is measured at constant junction temperature, using pulse testing with a low ON time.

Note 4: Current limit is measured by pulsing a short time.

Note 5: Dropout voltage is defined as the input to output differential at which the output voltage drops 100mV below the value measured with a 1V differential.

**TYPICAL PERFORMANCE CHARACTERISTICS**

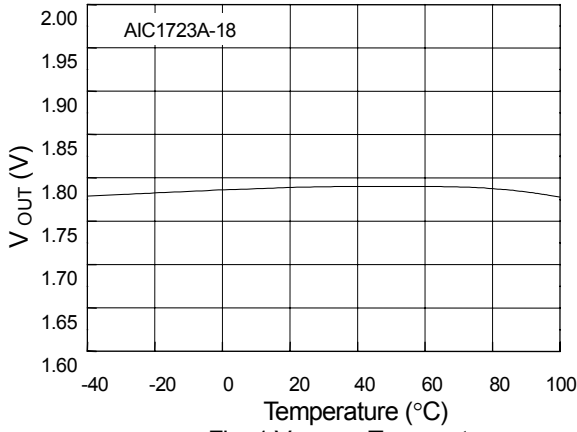

Fig. 1 V<sub>OUT</sub> vs. Temperature

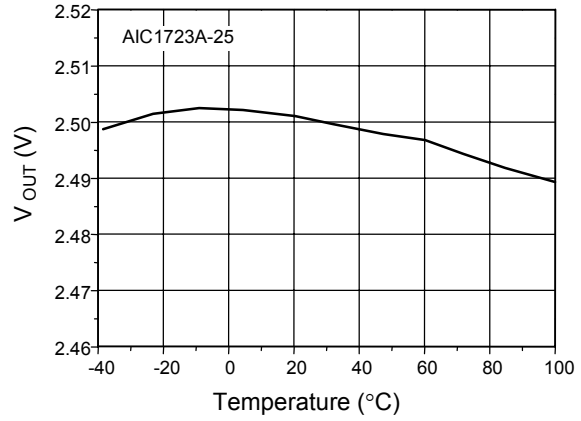

Fig. 2 V<sub>OUT</sub> vs. Temperature

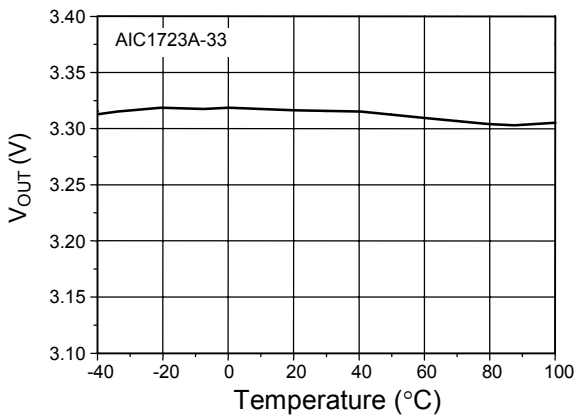

Fig. 3 V<sub>OUT</sub> vs. Temperature

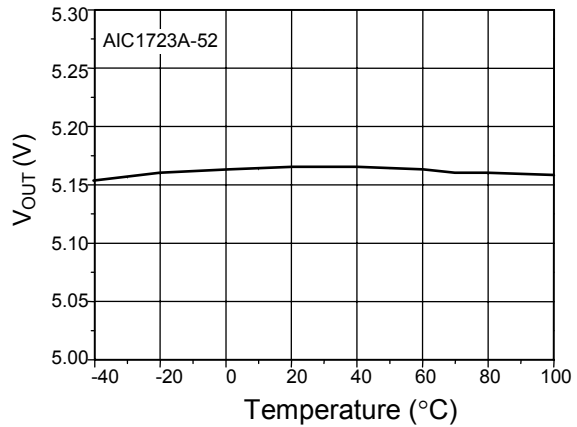

Fig. 4 V<sub>OUT</sub> vs. Temperature

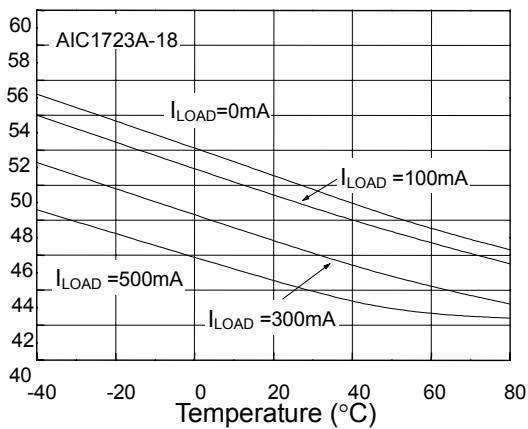

Fig. 5 Ground Current vs. Temperature

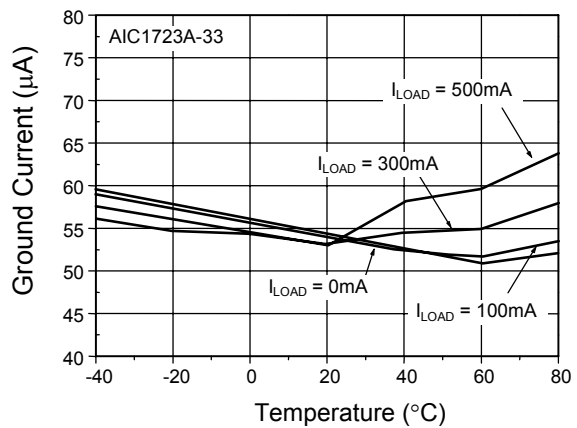

Fig. 6 Ground Current vs. Temperature

■ TYPICAL PERFORMANCE CHARACTERISTICS (Continued)

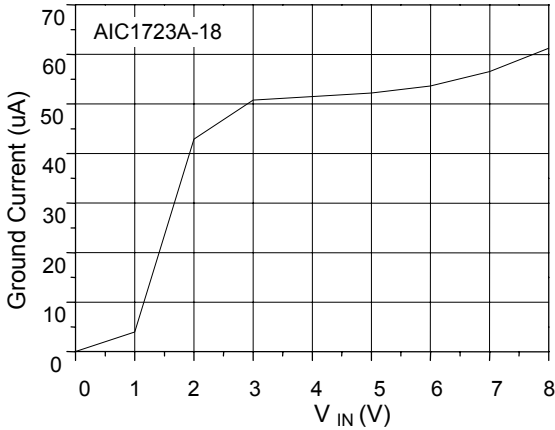

Fig. 7 Ground Current vs.  $V_{IN}$

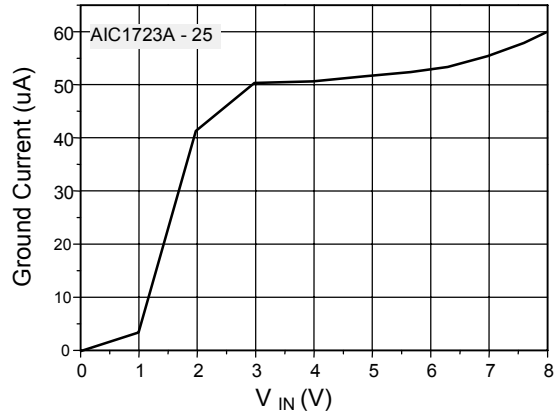

Fig. 8 Ground Current vs.  $V_{IN}$

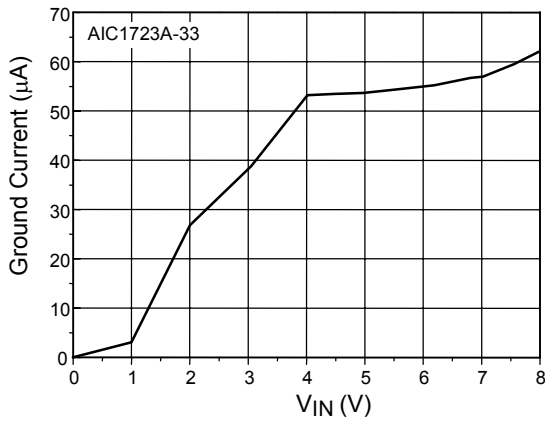

Fig. 9 Ground Current vs.  $V_{IN}$

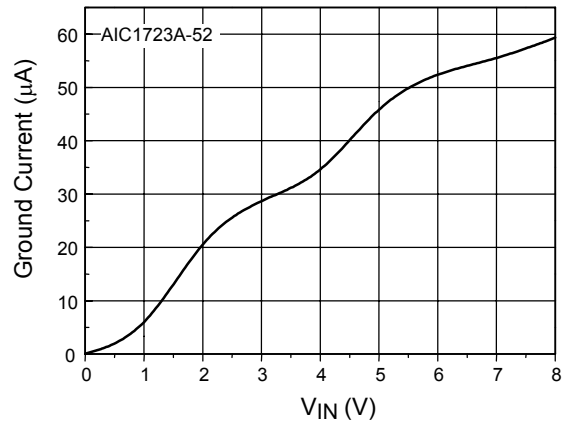

Fig. 10 Ground Current vs.  $V_{IN}$

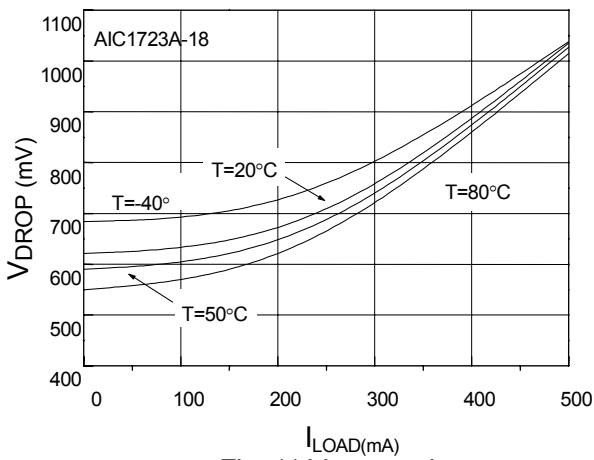

Fig. 11  $V_{DROP}$  vs.  $I_{LOAD}$

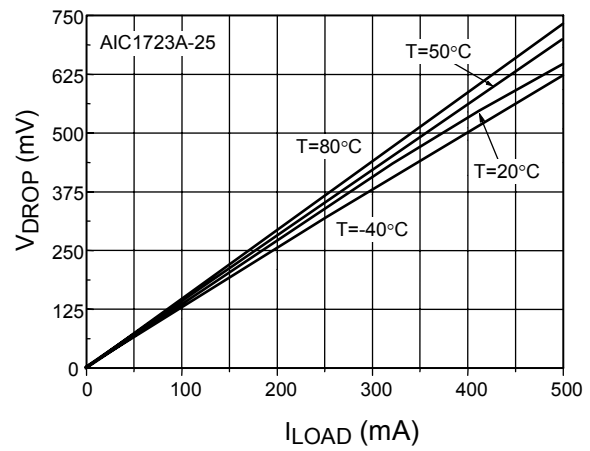

Fig. 12  $V_{DROP}$  vs.  $I_{LOAD}$

**TYPICAL PERFORMANCE CHARACTERISTICS (Continued)**

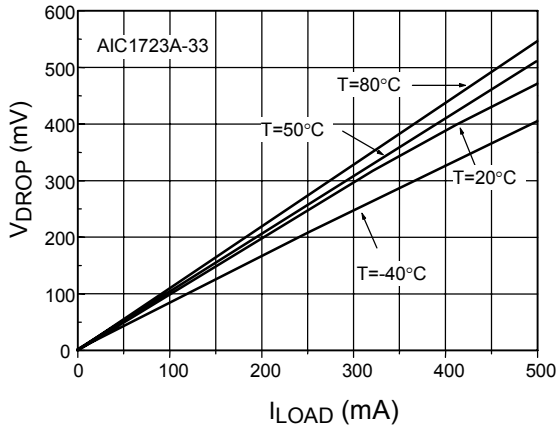

Fig. 13 V<sub>DROP</sub> vs. I<sub>LOAD</sub>

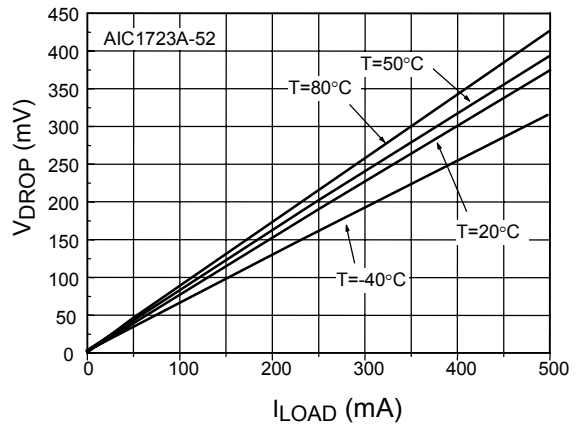

Fig. 14 V<sub>DROP</sub> vs. I<sub>LOAD</sub>

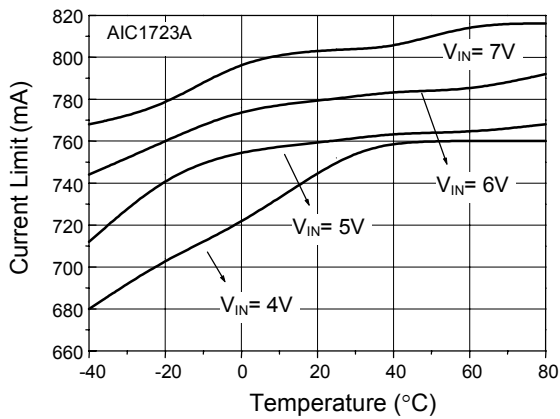
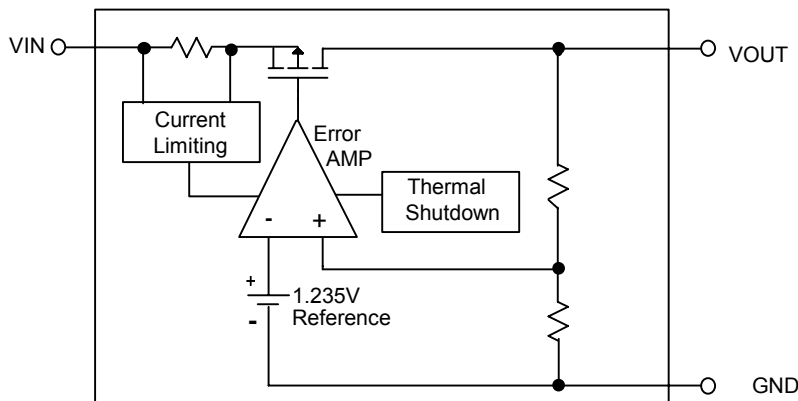

Fig. 15 Current Limit vs. Temperature

**BLOCK DIAGRAM**



## ■ PIN DESCRIPTIONS

VOUT PIN - Output pin.

GND PIN - Power GND.

VIN PIN - Power Supply Input.

## ■ APPLICATION INFORMATION

### INPUT-OUTPUT CAPACITORS

Linear regulators require input and output capacitors to maintain stability. Input capacitor at 1 $\mu$ F with 4.7 $\mu$ F aluminum electrolytic output capacitor is recommended.

### POWER DISSIPATION

The AIC1723A obtains thermal-limiting circuitry, which is designed to protect the device against overload condition. For continuous load condition, maximum rating of junction temperature must not be exceeded. It is important to pay more attention in thermal resistance. It includes junction to case, junction to ambient. The maximum power dissipation of AIC1723A depends on the thermal resistance of its case and circuit board, the temperature difference between the die junction and ambient air, and the rate of airflow. The rate of temperature rise is greatly affected by the mounting pad configuration on the PCB, the board material, and the ambient temperature. When the IC mounting with good thermal

conductivity is used, the junction temperature will be low even when large power dissipation applies.

The power dissipation across the device is

$$P = I_{OUT} (V_{IN} - V_{OUT}).$$

The maximum power dissipation is:

$$P_{MAX} = \frac{(T_{J-max} - T_A)}{R\theta_{JA}}$$

Where  $T_{J-max}$  is the maximum allowable junction temperature (125°C), and  $T_A$  is the ambient temperature suitable in application.

As a general rule, the lower temperature is, the better reliability of the device is. So the PCB mounting pad should provide maximum thermal conductivity to maintain low device temperature. GND pin performs a dual function for providing an electrical connection to ground and channeling heat away. Therefore, connecting the GND pin to ground with a large pad or ground plane would increase the power dissipation and reduce the device temperature.

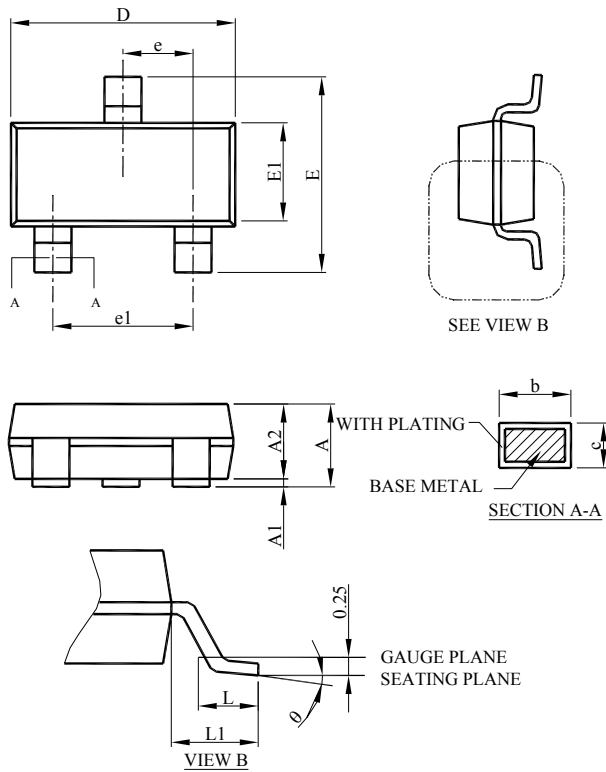

**PHYSICAL DIMENSIONS (unit: mm)**
**SOT-23**

SYMBOL	SOT-23	
	MILLIMETERS	
	MIN.	MAX.
A	0.95	1.45
A1	0.05	0.15
A2	0.90	1.30
b	0.30	0.50
c	0.08	0.22
D	2.80	3.00
E	2.60	3.00
E1	1.50	1.70
e	0.95 BSC	
e1	1.90 BSC	
L	0.30	0.60
L1	0.60 REF	
$\theta$	0°	8°

**Note:**

- 1.Refer to JEDEC MO-178.
- 2.Dimension D and E1 do not include mold flash, protrusions or gate burrs. Mold flash, protrusion or gate burrs shall not exceed 10 mil per side.
- 3.Controlling dimension is millimeter, converted inch dimensions are not necessarily exact.

● TO-252

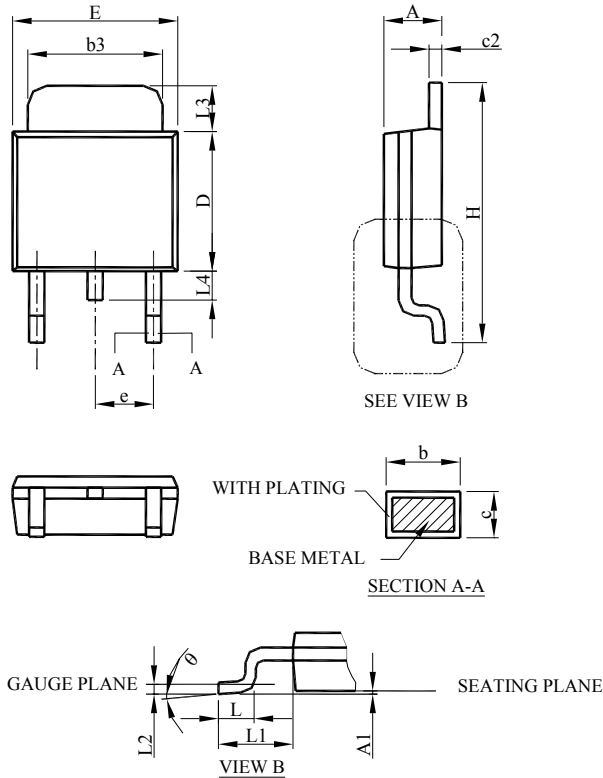

SYMBOL	TO-252-3L	
	MILLIMETERS	
	MIN.	MAX.
A	2.19	2.38
A1	0.00	0.13
b	0.64	0.89
b3	4.95	5.46
c	0.46	0.61
c2	0.46	0.89
D	5.33	6.22
E	6.35	6.73
e	2.28 BSC	
H	9.40	10.41
L	1.40	1.78
L1	2.67 REF	
L2	0.51 BSC	
L3	0.89	2.03
L4	--	1.02
$\theta$	0°	8°

- Note:
1. Refer to JEDEC TO-252AA and AB.
  2. Dimension D and E do not include mold flash, protrusions or gate burrs. Mold flash, protrusion or gate burrs shall not exceed 6 mil per side.
  3. Controlling dimension is millimeter, converted inch dimensions are not necessarily exact.

● SOT-89

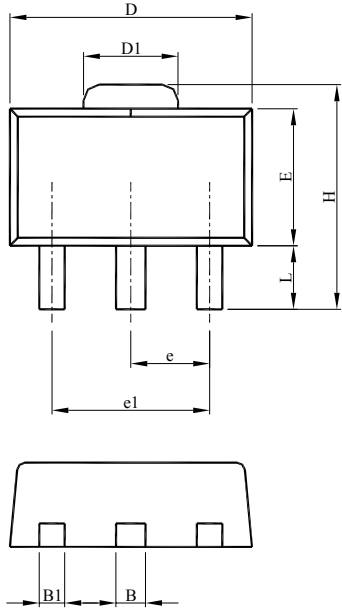

SOT-89		
MILLIMETERS		
SYMBOL	MIN.	MAX.
A	1.40	1.60
B	0.44	0.56
B1	0.36	0.48
C	0.35	0.44
D	4.40	4.60
D1	1.50	1.83
E	2.29	2.60
e	1.50 BSC	
e1	3.00 BSC	
H	3.94	4.25
L	0.89	1.20

Note:  
 1.Refer to JEDEC TO-243AA.  
 2.Controlling dimension is millimeter, converted inch dimensions are not necessarily exact.

● SOT-223

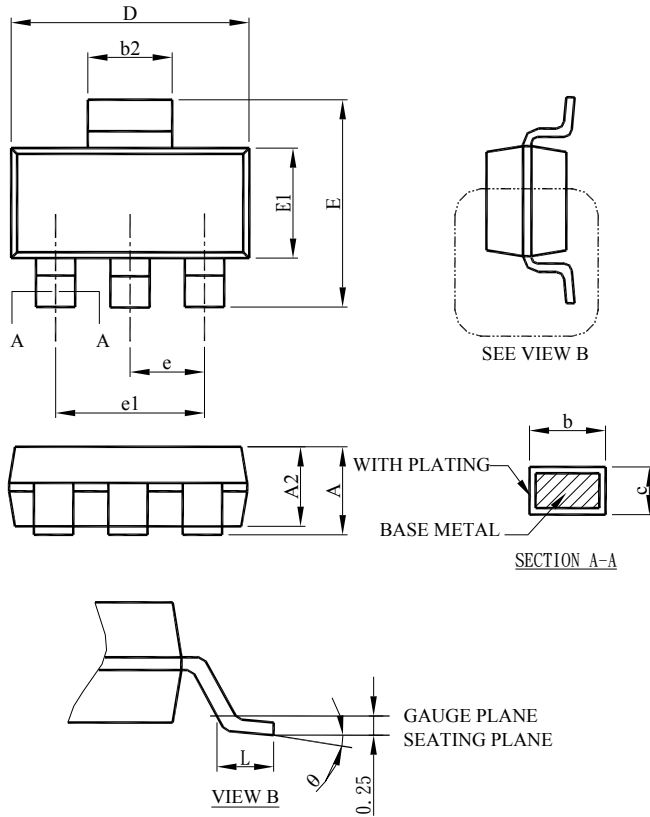

SYMBOL	SOT-223	
	MILLIMETERS	
	MIN.	MAX.
A		1.80
A1	0.02	0.10
A2	1.55	1.65
b	0.66	0.84
b2	2.90	3.10
c	0.23	0.33
D	6.30	6.70
E	6.70	7.30
E1	3.30	3.70
e	2.30 BSC	
e1	4.60 BSC	
L	0.90	
θ	0°	8°

Note:

- 1.Refer to JEDEC TO-261AA.
- 2.Dimension D and E1 are determined at the outermost extremes of the plastic body exclusive of mold flash, tie bar burrs, gate burrs, and interlead flash, but including any mismatch between the top and bottom of the plastic body.
- 3.Controlling dimension is millimeter, converted inch dimensions are not necessarily exact.

Note:

Information provided by AIC is believed to be accurate and reliable. However, we cannot assume responsibility for use of any circuitry other than circuitry entirely embodied in an AIC product; nor for any infringement of patents or other rights of third parties that may result from its use. We reserve the right to change the circuitry and specifications without notice.

Life Support Policy: AIC does not authorize any AIC product for use in life support devices and/or systems. Life support devices or systems are devices or systems which, (i) are intended for surgical implant into the body or (ii) support or sustain life, and whose failure to perform, when properly used in accordance with instructions for use provided in the labeling, can be reasonably expected to result in a significant injury to the user.