

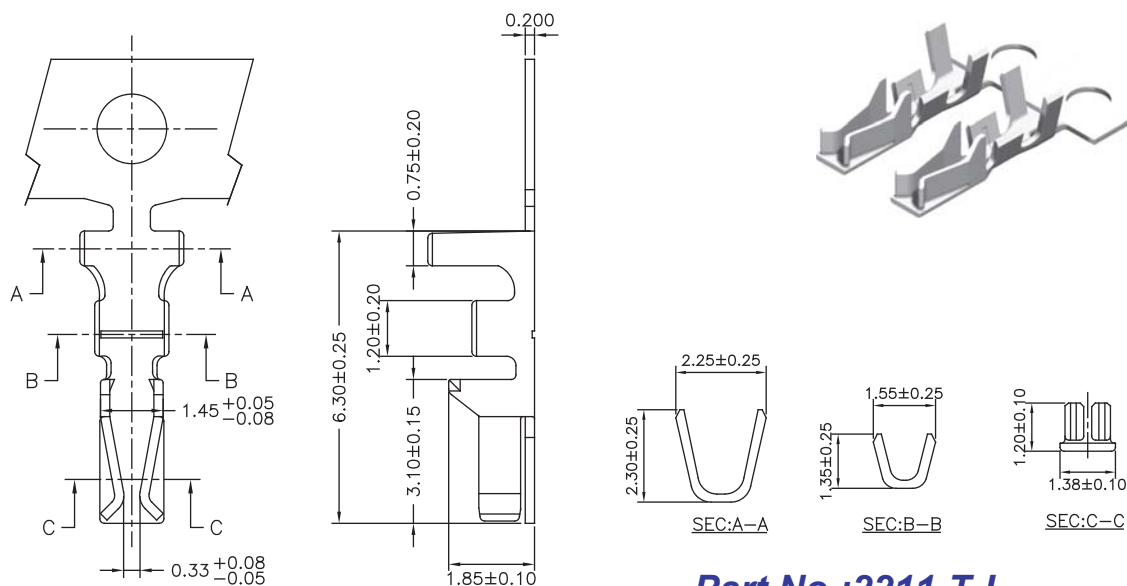

2.0mm Terminal / Housing



Part No.:2211-T-L

Wire Range	Insulation O.D.	Material	Finish
AWG#22-#30	1.45mm(max)	Phosphor Bronze	Tin Plated

Specifications

Current Rating: 3A AC,DC
 Voltage Rating: 250V AC,DC
 Temperature Range: -25°C to +85°C
 Contact Resistance: 30mΩ Max
 Insulation Resistance: 1000MΩ Min
 Withstanding Voltage: 1000V AC/minute
 Material:Nylon 66,UL94V-0

Part No.	Dimensions	
	A	B
2008H-02W-L	2.00	4.60
2008H-03W-L	4.00	6.60
2008H-04W-L	6.00	8.60
2008H-05W-L	8.00	10.60
2008H-06W-L	10.00	12.60
2008H-07W-L	12.00	14.60
2008H-08W-L	14.00	16.60
2008H-09W-L	16.00	18.60
2008H-10W-L	18.00	20.60
2008H-11W-L	20.00	22.60
2008H-12W-L	22.00	24.60
2008H-13W-L	24.00	26.60
2008H-14W-L	26.00	28.60
2008H-15W-L	28.00	30.60
2008H-16W-L	30.00	32.60

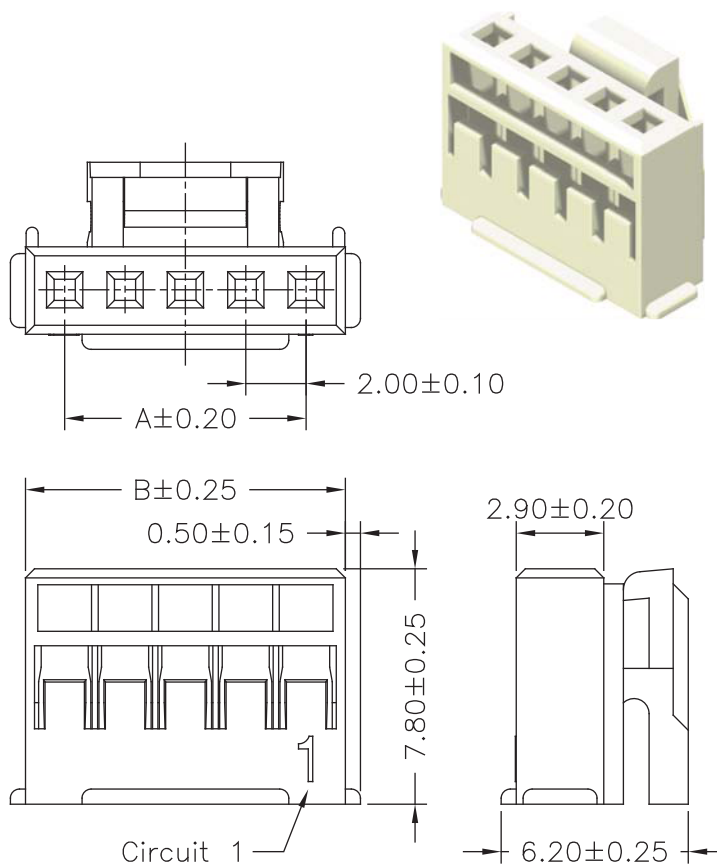

Part No.:2008H-XXW-L



2.0mm Wafer Right Angle / Straight Type

Specifications

Current Rating: 3A AC,DC
 Voltage Rating: 250V AC,DC
 Temperature Range: -25°C to +85°C
 Contact Resistance: 30mΩ Max
 Insulation Resistance: 1000MΩ Min
 Withstanding Voltage: 1000V AC/minute
 Terminal: Brass / Gold Plated
 Material:Nylon 46,UL94V-0

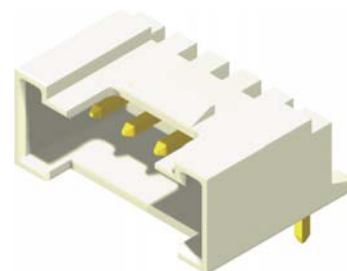

Part No.	Dimensions	
	A	B
2008R-02GW-U	2.00	6.00
2008R-03GW-U	4.00	8.00
2008R-04GW-U	6.00	10.00
2008R-05GW-U	8.00	12.00
2008R-06GW-U	10.00	14.00
2008R-07GW-U	12.00	16.00
2008R-08GW-U	14.00	18.00
2008R-09GW-U	16.00	20.00
2008R-10GW-U	18.00	22.00
2008R-11GW-U	20.00	24.00
2008R-12GW-U	22.00	26.00
2008R-13GW-U	24.00	28.00
2008R-14GW-U	26.00	30.00
2008R-15GW-U	28.00	32.00
2008R-16GW-U	30.00	34.00

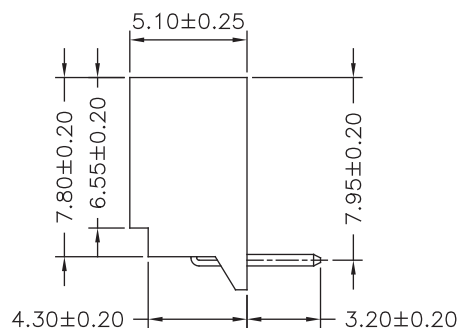
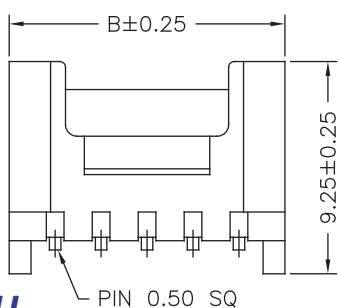
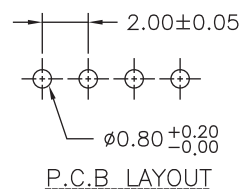
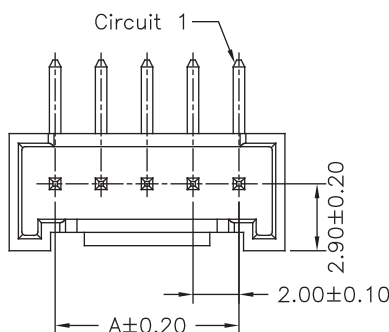

Part No.:2008R-XXGW-U

Specifications

Current Rating: 3A AC,DC
 Voltage Rating: 250V AC,DC
 Temperature Range: -25°C to +85°C
 Contact Resistance: 30mΩ Max
 Insulation Resistance: 1000MΩ Min
 Withstanding Voltage: 1000V AC/minute
 Terminal: Brass / Gold Plated
 Material:Nylon 46,UL94V-0

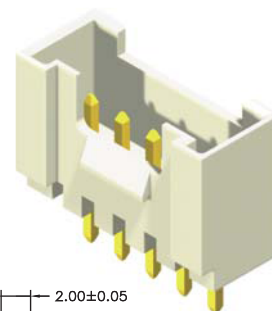

Part No.	Dimensions	
	A	B
2008S-02GW-U	2.00	6.00
2008S-03GW-U	4.00	8.00
2008S-04GW-U	6.00	10.00
2008S-05GW-U	8.00	12.00
2008S-06GW-U	10.00	14.00
2008S-07GW-U	12.00	16.00
2008S-08GW-U	14.00	18.00
2008S-09GW-U	16.00	20.00
2008S-10GW-U	18.00	22.00
2008S-11GW-U	20.00	24.00
2008S-12GW-U	22.00	26.00
2008S-13GW-U	24.00	28.00
2008S-14GW-U	26.00	30.00
2008S-15GW-U	28.00	32.00
2008S-16GW-U	30.00	34.00

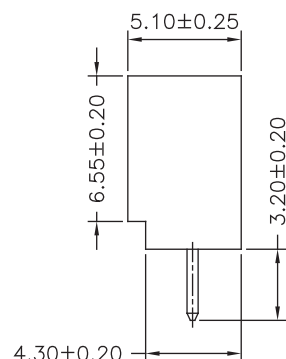
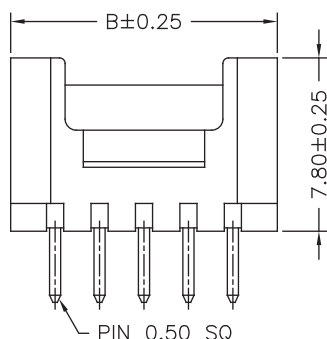
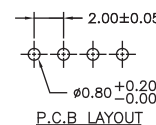
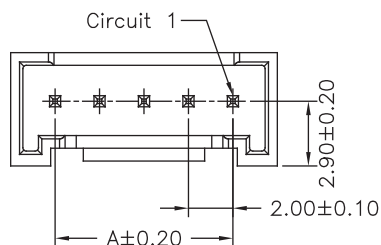

Part No.:2008S-XXGW-U