



# 1075ksps, 12-Bit, Parallel-Output ADCs with $\pm 10V$ , $\pm 5V$ , and 0 to +5V Analog Input Ranges

## General Description

The MAX1307/MAX1311/MAX1315 12-bit, analog-to-digital converters (ADCs) feature a 1075ksps sampling rate, a 20MHz input bandwidth, and three analog input ranges. The MAX1307 provides a 0 to +5V input range, with  $\pm 6V$  fault-tolerant inputs. The MAX1311 provides a  $\pm 5V$  input range with  $\pm 16.5V$  fault-tolerant inputs. The MAX1315 provides a  $\pm 10V$  input range with  $\pm 16.5V$  fault-tolerant inputs.

The MAX1307/MAX1311/MAX1315 include an on-chip 2.5V reference. These devices also accept an external +2V to +3V reference.

All devices operate from a +4.75 to +5.25V analog supply, and a +2.7V to +5.25V digital supply. The devices consume 36mA total supply current when fully operational. A 0.62 $\mu$ A shutdown mode is available to save power during idle periods.

A 20MHz, 12-bit, parallel data bus provides the conversion results. An internal 15MHz oscillator, or an externally applied clock, drives conversions.

Each device is available in a 48-pin 7mm x 7mm TQFP package and operates over the extended (-40°C to +85°C) temperature range.

## Applications

Industrial Process Control and Automation  
Vibration and Waveform Analysis  
Data-Acquisition Systems

## Pin Configuration

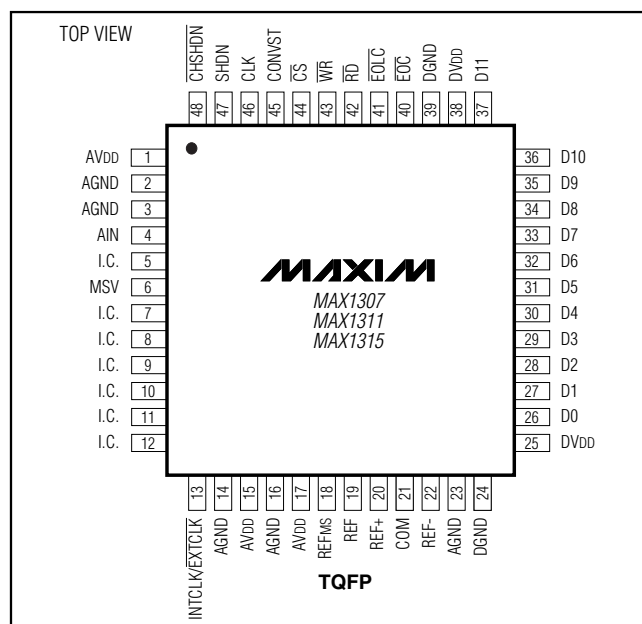

## Features

- ◆  $\pm 1$  LSB INL,  $\pm 0.9$  LSB DNL (max)
- ◆ 84dBc SFDR, -86dBc THD, 71dB SINAD,  $f_{IN} = 500$ kHz at -0.4dBFS
- ◆ Extended Input Ranges
  - 0 to +5V (MAX1307)
  - 5V to +5V (MAX1311)
  - 10V to +10V (MAX1315)
- ◆ Fault-Tolerant Inputs
  - $\pm 6V$  (MAX1307)
  - $\pm 16.5V$  (MAX1311/MAX1315)
- ◆ Fast 0.72 $\mu$ s Conversion Time
- ◆ 12-Bit, 20MHz Parallel Interface
- ◆ Internal or External Clock
- ◆ +2.5V Internal Reference or +2.0V to +3.0V External Reference
- ◆ +5V Analog Supply, +3V to +5V Digital Supply
  - 36mA Analog Supply Current
  - 1.3mA Digital Supply Current
  - Shutdown Mode
- ◆ 48-Pin TQFP Package (7mm x 7mm Footprint)

## Ordering Information

PART	TEMP RANGE	PIN-PACKAGE
MAX1307ECM	-40°C to +85°C	48 TQFP
MAX1311ECM	-40°C to +85°C	48 TQFP
MAX1315ECM	-40°C to +85°C	48 TQFP

## Selector Guide

PART	INPUT RANGE (V)	CHANNEL COUNT	PKG CODE
MAX1307EC	0 to +5	1	C48-6
MAX1311EC	$\pm 5$	1	C48-6
MAX1315EC	$\pm 10$	1	C48-6

# 1075ksp/s, 12-Bit, Parallel-Output ADCs with $\pm 10V$ , $\pm 5V$ , and 0 to +5V Analog Input Ranges

## ABSOLUTE MAXIMUM RATINGS

AVDD to AGND .....	-0.3V to +6V	REFMS, REF, MSV to AGND .....	-0.3V to (AVDD + 0.3V)
DVDD to DGND .....	-0.3V to +6V	REF+, COM, REF- to AGND .....	-0.3V to (AVDD + 0.3V)
AGND to DGND .....	-0.3V to +0.3V	Maximum Current into Any Pin Except AVDD, DVDD, AGND, DGND .....	$\pm 50mA$
CH0, I.C. to AGND (MAX1307) .....	$\pm 6V$	Continuous Power Dissipation (TA = +70°C)	
CH0, I.C. to AGND (MAX1311) .....	$\pm 16.5V$	TQFP (derate 22.7mW/°C above +70°C) .....	1818.2mW
CH0, I.C. to AGND (MAX1315) .....	$\pm 16.5V$	Operating Temperature Range .....	-40°C to +85°C
D0-D11 to DGND .....	-0.3V to (DVDD + 0.3V)	Junction Temperature .....	+150°C
EOC, EOLC, RD, WR, CS to DGND .....	-0.3V to (DVDD + 0.3V)	Storage Temperature Range .....	-65°C to +150°C
CONVST, CLK, SHDN, CHSHDN to DGND .....	-0.3V to (DVDD + 0.3V)	Lead Temperature (soldering, 10s) .....	+300°C
INTCLK/EXTCLK to AGND .....	-0.3V to (AVDD + 0.3V)		

Stresses beyond those listed under "Absolute Maximum Ratings" may cause permanent damage to the device. These are stress ratings only, and functional operation of the device at these or any other conditions beyond those indicated in the operational sections of the specifications is not implied. Exposure to absolute maximum rating conditions for extended periods may affect device reliability.

## ELECTRICAL CHARACTERISTICS

(AVDD = +5V, DVDD = +3V, AGND = DGND = 0, VREF = VREFMS = +2.5V (external reference), CREF = CREFMS = 0.1 $\mu$ F, CREF+ = CREF- = 0.1 $\mu$ F, CREF+to-REF- = 2.2 $\mu$ F || 0.1 $\mu$ F, CCOM = 2.2 $\mu$ F || 0.1 $\mu$ F, CMSV = 2.2 $\mu$ F || 0.1 $\mu$ F (unipolar devices), MSV = AGND (bipolar devices), fCLK = 16.67MHz 50% duty cycle, INTCLK/EXTCLK = AGND (external clock), SHDN = DGND, TA = TMIN to TMAX, unless otherwise noted. Typical values are at TA = +25°C.) (See Figures 3 and 4)

PARAMETER	SYMBOL	CONDITIONS	MIN	TYP	MAX	UNITS
<b>STATIC PERFORMANCE (Note 1)</b>						
Resolution	N		12			Bits
Integral Nonlinearity	INL			$\pm 0.5$	$\pm 1.0$	LSB
Differential Nonlinearity	DNL	No missing codes		$\pm 0.3$	$\pm 0.9$	LSB
Offset Error		Unipolar, 0x000 to 0x001		$\pm 3$	$\pm 10$	LSB
		Bipolar, 0xFFF to 0x000		$\pm 3$	$\pm 15$	
Offset-Error Temperature Drift		Unipolar, 0x000 to 0x001		7		ppm/°C
		Bipolar, 0xFFF to 0x000		7		
Gain Error				$\pm 2$	$\pm 16$	LSB
Gain-Error Temperature Drift				4		ppm/°C
<b>DYNAMIC PERFORMANCE AT fIN = 500kHz, AIN = -0.4dBFS</b>						
Signal-to-Noise Ratio	SNR		68	71		dB
Signal-to-Noise Plus Distortion	SINAD		68	71		dB
Total Harmonic Distortion	THD			-86	-80	dBc
Spurious-Free Dynamic Range	SFDR			84		dBc
<b>ANALOG INPUTS (AIN)</b>						
Input Voltage	VAIN	MAX1307		0	+5	V
		MAX1311		-5	+5	
		MAX1315		-10	+10	
Input Resistance (Note 2)	RAIN	MAX1307		7.58		k $\Omega$
		MAX1311		8.66		
		MAX1315		14.26		
Input Current (Note 2)	IAIN	MAX1307	VCH = +5V	0.54	0.72	mA
			VCH = 0V	-0.157	-0.12	
		MAX1311	VCH = +5V	0.29	0.39	
			VCH = -5V	-1.16	-0.87	
		MAX1315	VCH = +10V	0.56	0.74	
			VCH = -10V	-1.13	-0.85	

# 1075ksps, 12-Bit, Parallel-Output ADCs with $\pm 10V$ , $\pm 5V$ , and 0 to +5V Analog Input Ranges

MAX1307/MAX1311/MAX1315

## ELECTRICAL CHARACTERISTICS (continued)

( $V_{DD} = +5V$ ,  $DV_{DD} = +3V$ ,  $AGND = DGND = 0$ ,  $V_{REF} = V_{REFMS} = +2.5V$  (external reference),  $C_{REF} = C_{REFMS} = 0.1\mu F$ ,  $C_{REF+} = C_{REF-} = 0.1\mu F$ ,  $C_{REF+-to-REF-} = 2.2\mu F \parallel 0.1\mu F$ ,  $C_{COM} = 2.2\mu F \parallel 0.1\mu F$ ,  $C_{MSV} = 2.2\mu F \parallel 0.1\mu F$  (unipolar devices),  $MSV = AGND$  (bipolar devices),  $f_{CLK} = 16.67MHz$  50% duty cycle,  $INTCLK/EXTCLK = AGND$  (external clock),  $SHDN = DGND$ ,  $T_A = T_{MIN}$  to  $T_{MAX}$ , unless otherwise noted. Typical values are at  $T_A = +25^\circ C$ .) (See Figures 3 and 4)

PARAMETER	SYMBOL	CONDITIONS	MIN	TYP	MAX	UNITS
Input Capacitance	$C_{AIN}$			15		pF
<b>TRACK/HOLD</b>						
External-Clock Throughput Rate	$f_{TH}$	(Note 3)		1075		ksps
Internal-Clock Throughput Rate	$f_{TH}$	(Note 3)		983		ksps
Small-Signal Bandwidth				20		MHz
Full-Power Bandwidth				20		MHz
Aperture Delay	$t_{AD}$			8		ns
Aperture Jitter	$t_{AJ}$			50		psRMS
<b>INTERNAL REFERENCE</b>						
REF Output Voltage	$V_{REF}$		2.475	2.500	2.525	V
Reference Output-Voltage Temperature Drift				30		ppm/ $^\circ C$
REF <sub>MS</sub> Output Voltage	$V_{REFMS}$		2.475	2.500	2.525	V
REF+ Output Voltage	$V_{REF+}$			3.850		V
COM Output Voltage	$V_{COM}$			2.600		V
REF- Output Voltage	$V_{REF-}$			1.350		V
Differential Reference Voltage	$V_{REF+} - V_{REF-}$			2.500		V
<b>EXTERNAL REFERENCE (REF and REF<sub>MS</sub> are externally driven)</b>						
REF Input Voltage Range	$V_{REF}$		2.0	2.5	3.0	V
REF Input Resistance	$R_{REF}$	(Note 4)		5		k $\Omega$
REF Input Capacitance				15		pF
REF <sub>MS</sub> Input Voltage Range	$V_{REFMS}$		2.0	2.5	3.0	V
REF <sub>MS</sub> Input Resistance	$R_{REFMS}$	(Note 5)		5		k $\Omega$
REF <sub>MS</sub> Input Capacitance				15		pF
REF+ Output Voltage	$V_{REF+}$	$V_{REF} = +2.5V$		3.850		V
COM Output Voltage	$V_{COM}$	$V_{REF} = +2.5V$		2.600		V
REF- Output Voltage	$V_{REF-}$	$V_{REF} = +2.5V$		1.350		V
Differential Reference Voltage	$V_{REF+} - V_{REF-}$	$V_{REF} = +2.5V$		2.500		V
<b>DIGITAL INPUTS (<math>\overline{RD}</math>, <math>\overline{WR}</math>, <math>\overline{CS}</math>, <math>CLK</math>, <math>SHDN</math>, <math>CHSHDN</math>, <math>CONVST</math>)</b>						
Input-Voltage High	$V_{IH}$		0.7 x $DV_{DD}$			V
Input-Voltage Low	$V_{IL}$		0.3 x $DV_{DD}$			V
Input Hysteresis			20			mV

# 1075ksps, 12-Bit, Parallel-Output ADCs with $\pm 10V$ , $\pm 5V$ , and 0 to +5V Analog Input Ranges

## ELECTRICAL CHARACTERISTICS (continued)

( $AV_{DD} = +5V$ ,  $DV_{DD} = +3V$ ,  $AGND = DGND = 0$ ,  $V_{REF} = V_{REFMS} = +2.5V$  (external reference),  $C_{REF} = C_{REFMS} = 0.1\mu F$ ,  $C_{REF+} = C_{REF-} = 0.1\mu F$ ,  $C_{REF+to-REF-} = 2.2\mu F \parallel 0.1\mu F$ ,  $C_{COM} = 2.2\mu F \parallel 0.1\mu F$ ,  $C_{MSV} = 2.2\mu F \parallel 0.1\mu F$  (unipolar devices),  $MSV = AGND$  (bipolar devices),  $f_{CLK} = 16.67MHz$  50% duty cycle,  $INTCLK/EXTCLK = AGND$  (external clock),  $SHDN = DGND$ ,  $T_A = T_{MIN}$  to  $T_{MAX}$ , unless otherwise noted. Typical values are at  $T_A = +25^{\circ}C$ .) (See Figures 3 and 4)

PARAMETER	SYMBOL	CONDITIONS	MIN	TYP	MAX	UNITS
Input Capacitance	$C_{IN}$			15		pF
Input Current	$I_{IN}$	$V_{IN} = 0$ or $DV_{DD}$		0.02	$\pm 1$	$\mu A$
<b>CLOCK-SELECT INPUT (INTCLK/EXTCLK)</b>						
Input-Voltage High	$V_{IH}$		0.7 x $AV_{DD}$			V
Input-Voltage Low	$V_{IL}$		0.3 x $AV_{DD}$			V
<b>DIGITAL OUTPUTS (D0–D11, EOC, EOLC)</b>						
Output-Voltage High	$V_{OH}$	$I_{SOURCE} = 0.8mA$ , Figure 1	$DV_{DD} - 0.6$			V
Output-Voltage Low	$V_{OL}$	$I_{SINK} = 1.6mA$ , Figure 1			0.4	V
D0–D11 Tri-State Leakage Current		$\overline{RD} = \text{high}$ or $\overline{CS} = \text{high}$		0.06	1	$\mu A$
D0–D11 Tri-State Output Capacitance		$\overline{RD} = \text{high}$ or $\overline{CS} = \text{high}$		15		pF
<b>POWER SUPPLIES</b>						
Analog Supply Voltage	$AV_{DD}$		4.75		5.25	V
Digital Supply Voltage	$DV_{DD}$		2.70		5.25	V
Analog Supply Current	$I_{AVDD}$	MAX1307		36	39	mA
		MAX1311		34	36	
		MAX1315		34	36	
Digital Supply Current ( $C_{LOAD} = 100pF$ ) (Note 6)	$I_{DVDD}$	MAX1307		1.3	2.6	mA
		MAX1311		1.3	2.6	
		MAX1315		1.3	2.6	
Shutdown Current (Note 7)	$I_{AVDD}$	$SHDN = DV_{DD}$ , $V_{CH} = \text{float}$		0.6	10	$\mu A$
	$I_{DVDD}$	$SHDN = DV_{DD}$ , $\overline{RD} = \overline{WR} = \text{high}$		0.02	1	
Power-Supply Rejection Ratio	PSRR	$AV_{DD} = +4.75V$ to $+5.25V$		50		dB
<b>TIMING CHARACTERISTICS (Figure 1)</b>						
Time to Conversion Result	$t_{CONV}$	Internal clock, Figure 6		800	900	ns
		External clock, Figure 7		12		CLK cycles
CONVST Pulse-Width Low (Acquisition Time)	$t_{ACQ}$	Figures 6, 7 (Note 8)	0.1		1000.0	$\mu s$
$\overline{CS}$ to $\overline{RD}$	$t_{CTR}$	Figures 6, 7		(Note 9)		ns
$\overline{RD}$ to $\overline{CS}$	$t_{RTC}$	Figures 6, 7		(Note 9)		ns
Data Access Time ( $\overline{RD}$ Low to Valid Data)	$t_{ACC}$	Figures 6, 7			30	ns
Bus Relinquish Time ( $\overline{RD}$ High)	$t_{REQ}$	Figures 6, 7	5		30	ns
CLK Rise to EOC Delay	$t_{EOCD}$	Figure 7		20		ns
CLK Rise to EOLC Fall Delay	$t_{EOLCD}$	Figure 7		20		ns
CONVST Fall to EOLC Rise Delay	$t_{CVEOLCD}$	Figures 6, 7		20		ns

# 1075ksps, 12-Bit, Parallel-Output ADCs with ±10V, ±5V, and 0 to +5V Analog Input Ranges

MAX1307/MAX1311/MAX1315

## ELECTRICAL CHARACTERISTICS (continued)

(AVDD = +5V, DVDD = +3V, AGND = DGND = 0, VREF = VREFMS = +2.5V (external reference), CREF = CREFMS = 0.1μF, CREF+ = CREF- = 0.1μF, CREF+-to-REF- = 2.2μF || 0.1μF, CCOM = 2.2μF || 0.1μF, CMSV = 2.2μF || 0.1μF (unipolar devices), MSV = AGND (bipolar devices), fCLK = 16.67MHz 50% duty cycle, INTCLK/EXTCLK = AGND (external clock), SHDN = DGND, TA = TMIN to TMAX, unless otherwise noted. Typical values are at TA = +25°C.) (See Figures 3 and 4)

PARAMETER	SYMBOL	CONDITIONS	MIN	TYP	MAX	UNITS
EOC Pulse Width	tEOC	Internal clock, Figure 6	50			ns
		External clock, Figure 7		1		CLK cycles
External CLK Period	tCLK	Figure 7	0.05		10.00	μs
External CLK High Period	tCLKH	Logic sensitive to rising edges, Figure 7	20			ns
External CLK Low Period	tCLKL	Logic sensitive to rising edges, Figure 7	20			ns
External Clock Frequency	fCLK	(Note 10)	0.1		20.0	MHz
Internal Clock Frequency	fINT			15		MHz
CONVST High to CLK Edge	tCNTC	Figure 7	20			ns

**Note 1:** For the MAX1307, VIN = 0 to +5V. For the MAX1311, VIN = -5V to +5V. For the MAX1315, VIN = -10V to +10V.

**Note 2:** The analog input resistance is terminated to an internal bias point (Figure 5). Calculate the analog input current using:

$$I_{AIN} = \frac{V_{AIN} - V_{BIAS}}{R_{AIN}}$$

for AIN within the input voltage range.

**Note 3:** Throughput rate is a function of clock frequency (fCLK). The external clock throughput rate is specified with fCLK = 16.67MHz and the internal clock throughput rate is specified with fCLK = 15MHz. See the *Data Throughput* section for more information.

**Note 4:** The REF input resistance is terminated to an internal +2.5V bias point (Figure 2). Calculate the REF input current using:

$$I_{REF} = \frac{V_{REF} - 2.5V}{R_{REF}}$$

for VREF within the input voltage range.

**Note 5:** The REFMS input resistance is terminated to an internal +2.5V bias point (Figure 2). Calculate the REFMS input current using:

$$I_{REFMS} = \frac{V_{REFMS} - 2.5V}{R_{REFMS}}$$

for VREFMS within the input voltage range.

**Note 6:** The analog input is driven with a -0.4dBFS 500kHz sine wave.

**Note 7:** Shutdown current is measured with the analog input floating. The large amplitude of the maximum shutdown-current specification is due to automated test equipment limitations.

**Note 8:** CONVST must remain low for at least the acquisition period. The maximum acquisition time is limited by internal capacitor droop.

**Note 9:** CS to WR and CS to RD are internally AND together. Setup and hold times do not apply.

**Note 10:** Minimum CLK frequency is limited only by the internal T/H droop rate. Limit the time between the rising edge of CONVST and the falling edge of EOLC to a maximum of 1ms.

# 1075ksp/s, 12-Bit, Parallel-Output ADCs with $\pm 10V$ , $\pm 5V$ , and 0 to +5V Analog Input Ranges

## Typical Operating Characteristics

( $V_{DD} = +5V$ ,  $DV_{DD} = +3V$ ,  $AGND = DGND = 0$ ,  $V_{REF} = V_{REFMS} = +2.5V$  (external reference),  $C_{REF} = C_{REFMS} = 0.1\mu F$ ,  $C_{REF+} = C_{REF-} = 0.1\mu F$ ,  $C_{REF+to-REF-} = 2.2\mu F \parallel 0.1\mu F$ ,  $C_{COM} = 2.2\mu F \parallel 0.1\mu F$ ,  $C_{MSV} = 2.2\mu F \parallel 0.1\mu F$  (unipolar devices),  $MSV = AGND$  (bipolar devices),  $f_{CLK} = 16.67MHz$  50% duty cycle,  $INTCLK/EXTCLK = AGND$  (external clock),  $f_{IN} = 500kHz$ ,  $A_{IN} = -0.4dBFS$ .  $T_A = +25^\circ C$ , unless otherwise noted.) (Figures 3 and 4)

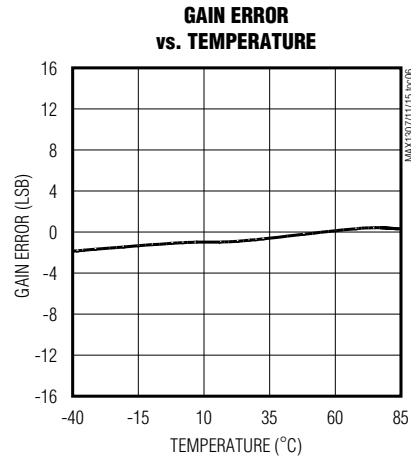
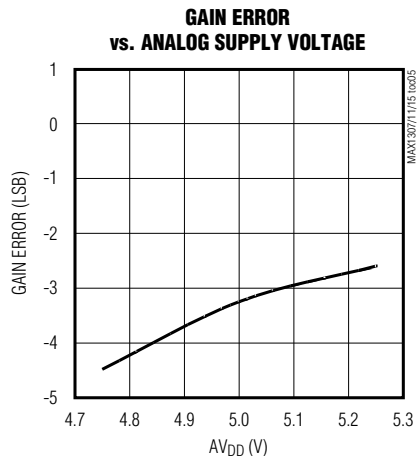
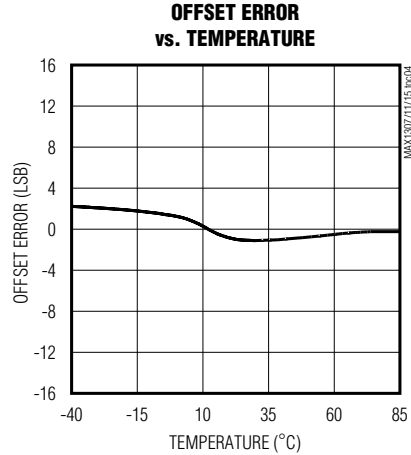
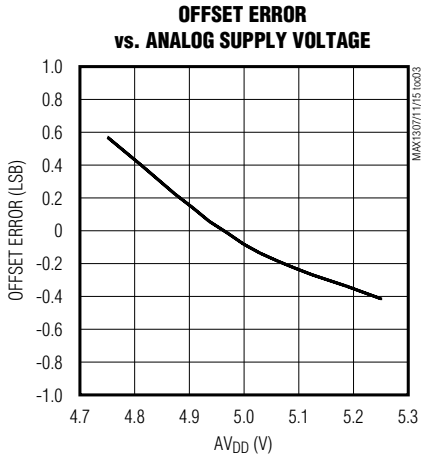
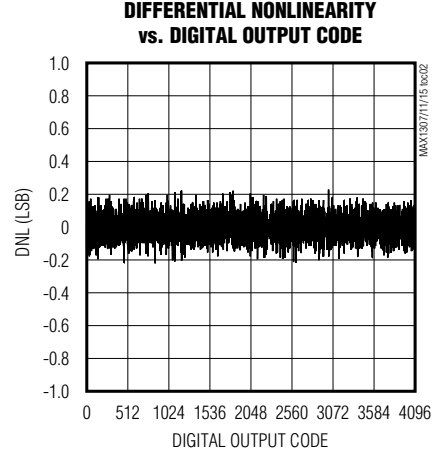
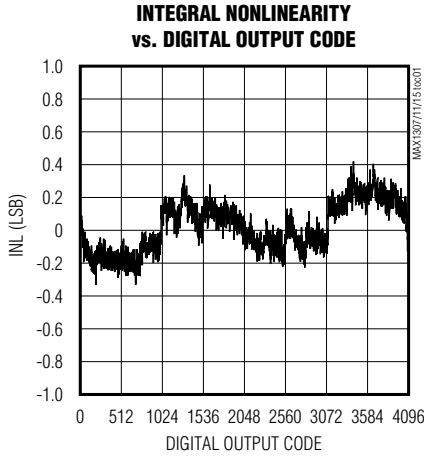

# 1075ksps, 12-Bit, Parallel-Output ADCs with $\pm 10V$ , $\pm 5V$ , and 0 to +5V Analog Input Ranges

## Typical Operating Characteristics (continued)

( $AV_{DD} = +5V$ ,  $DV_{DD} = +3V$ ,  $AGND = DGND = 0$ ,  $V_{REF} = V_{REFMS} = +2.5V$  (external reference),  $C_{REF} = C_{REFMS} = 0.1\mu F$ ,  $C_{REF+} = C_{REF-} = 0.1\mu F$ ,  $C_{REF+to-REF-} = 2.2\mu F \parallel 0.1\mu F$ ,  $C_{COM} = 2.2\mu F \parallel 0.1\mu F$ ,  $C_{MSV} = 2.2\mu F \parallel 0.1\mu F$  (unipolar devices),  $MSV = AGND$  (bipolar devices),  $f_{CLK} = 16.67MHz$  50% duty cycle,  $INTCLK/EXTCLK = AGND$  (external clock),  $f_{IN} = 500kHz$ ,  $A_{IN} = -0.4dBFS$ .  $T_A = +25^{\circ}C$ , unless otherwise noted.) (Figures 3 and 4)

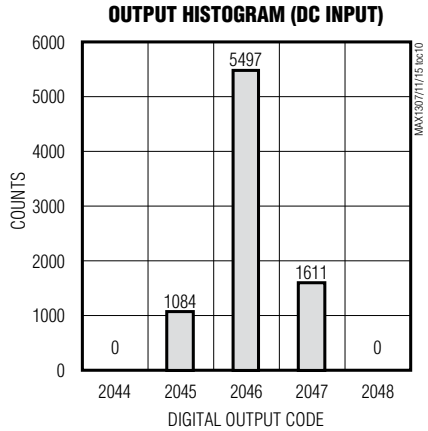
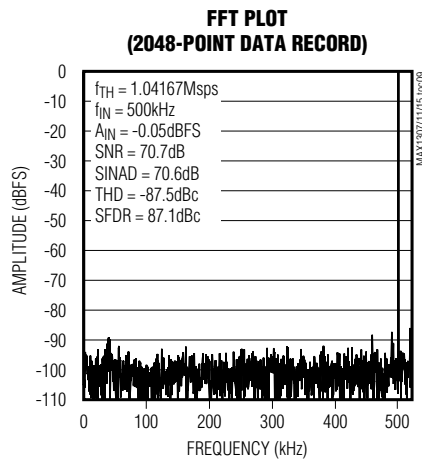
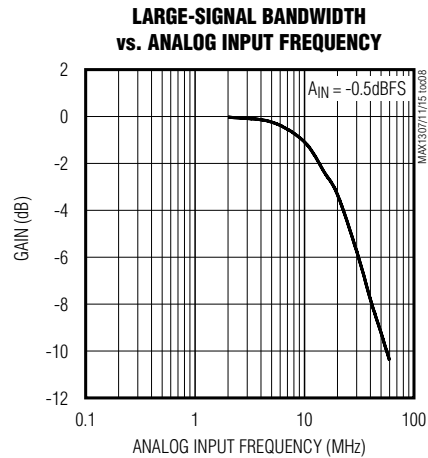
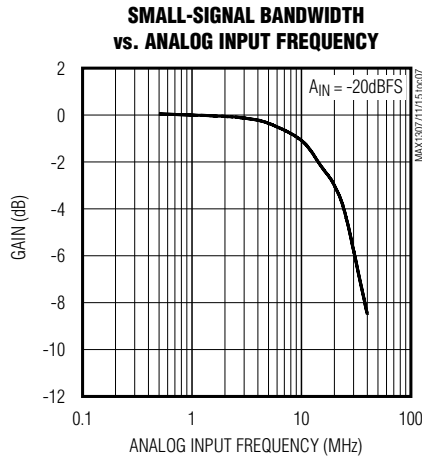

MAX1307/MAX1311/MAX1315

# 1075ksps, 12-Bit, Parallel-Output ADCs with $\pm 10V$ , $\pm 5V$ , and 0 to +5V Analog Input Ranges

## Typical Operating Characteristics (continued)

(AVDD = +5V, DVDD = +3V, AGND = DGND = 0, VREF = VREFMS = +2.5V (external reference), CREF = CREFMS = 0.1 $\mu$ F, CREF+ = CREF- = 0.1 $\mu$ F, CREF+-to-REF- = 2.2 $\mu$ F || 0.1 $\mu$ F, CCOM = 2.2 $\mu$ F || 0.1 $\mu$ F, CMSV = 2.2 $\mu$ F || 0.1 $\mu$ F (unipolar devices), MSV = AGND (bipolar devices), fCLK = 16.67MHz 50% duty cycle, INTCLK/EXTCLK = AGND (external clock), fIN = 500kHz, AIN = -0.4dBFS. TA = +25°C, unless otherwise noted.) (Figures 3 and 4)

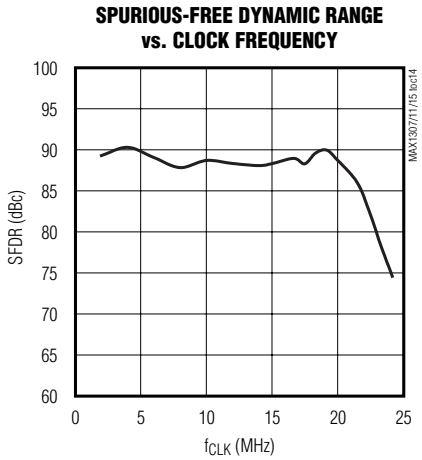
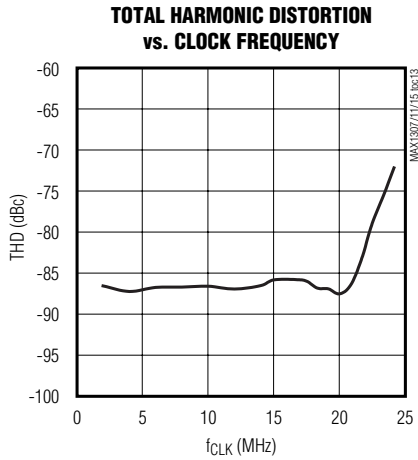
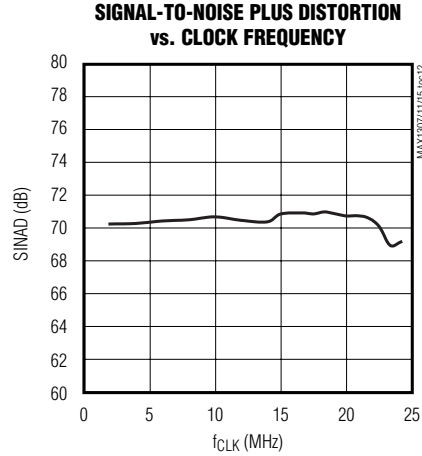
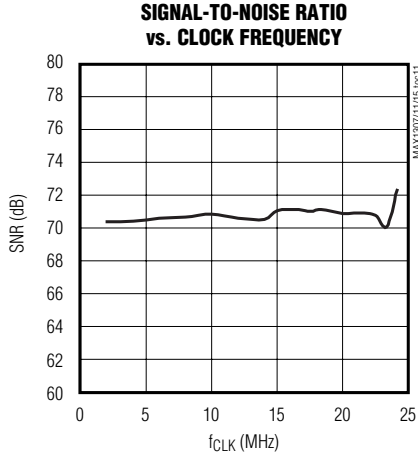



# 1075ksps, 12-Bit, Parallel-Output ADCs with $\pm 10V$ , $\pm 5V$ , and 0 to +5V Analog Input Ranges

## Typical Operating Characteristics (continued)

( $V_{DD} = +5V$ ,  $DV_{DD} = +3V$ ,  $AGND = DGND = 0$ ,  $V_{REF} = V_{REFMS} = +2.5V$  (external reference),  $C_{REF} = C_{REFMS} = 0.1\mu F$ ,  $C_{REF+} = C_{REF-} = 0.1\mu F$ ,  $C_{REF+to-REF-} = 2.2\mu F \parallel 0.1\mu F$ ,  $C_{COM} = 2.2\mu F \parallel 0.1\mu F$ ,  $C_{MSV} = 2.2\mu F \parallel 0.1\mu F$  (unipolar devices),  $MSV = AGND$  (bipolar devices),  $f_{CLK} = 16.67MHz$  50% duty cycle,  $INTCLK/EXTCLK = AGND$  (external clock),  $f_{IN} = 500kHz$ ,  $A_{IN} = -0.4dBFS$ .  $T_A = +25^\circ C$ , unless otherwise noted.) (Figures 3 and 4)

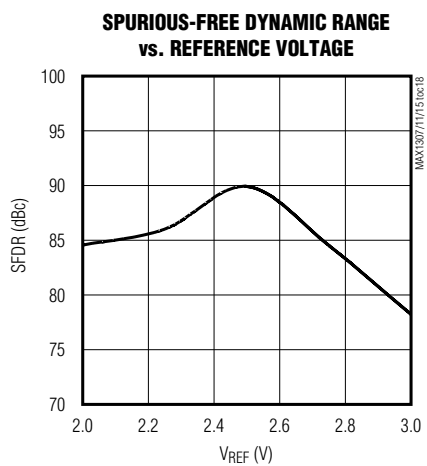
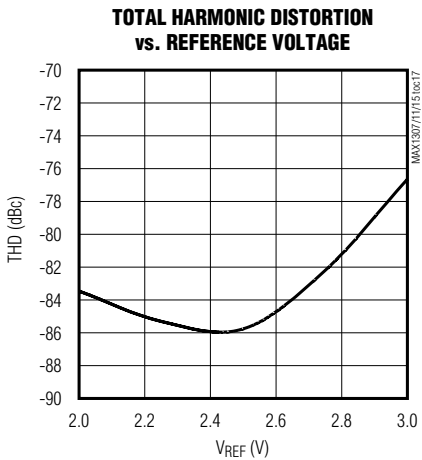
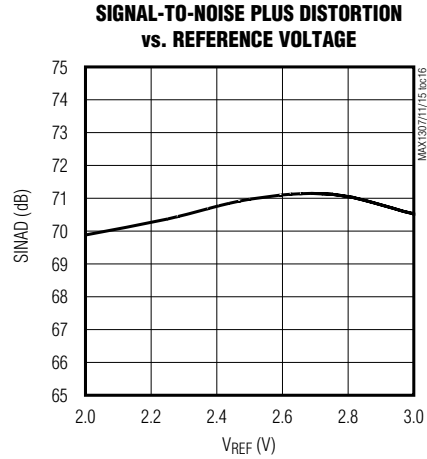
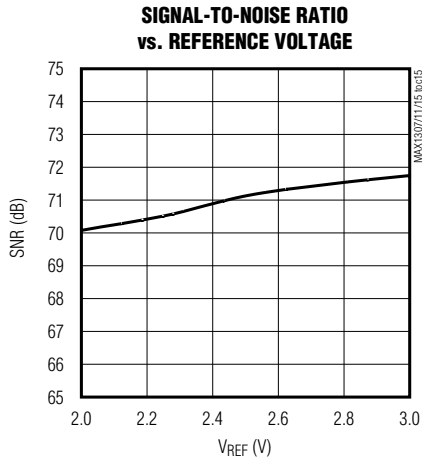

MAX1307/MAX1311/MAX1315

# 1075ksps, 12-Bit, Parallel-Output ADCs with $\pm 10V$ , $\pm 5V$ , and 0 to +5V Analog Input Ranges

## Typical Operating Characteristics (continued)

( $AV_{DD} = +5V$ ,  $DV_{DD} = +3V$ ,  $AGND = DGND = 0$ ,  $V_{REF} = V_{REFMS} = +2.5V$  (external reference),  $C_{REF} = C_{REFMS} = 0.1\mu F$ ,  $C_{REF+} = C_{REF-} = 0.1\mu F$ ,  $C_{REF+to-REF-} = 2.2\mu F \parallel 0.1\mu F$ ,  $C_{COM} = 2.2\mu F \parallel 0.1\mu F$ ,  $C_{MSV} = 2.2\mu F \parallel 0.1\mu F$  (unipolar devices),  $MSV = AGND$  (bipolar devices),  $f_{CLK} = 16.67MHz$  50% duty cycle,  $INTCLK/EXTCLK = AGND$  (external clock),  $f_{IN} = 500kHz$ ,  $A_{IN} = -0.4dBFS$ .  $T_A = +25^\circ C$ , unless otherwise noted.) (Figures 3 and 4)

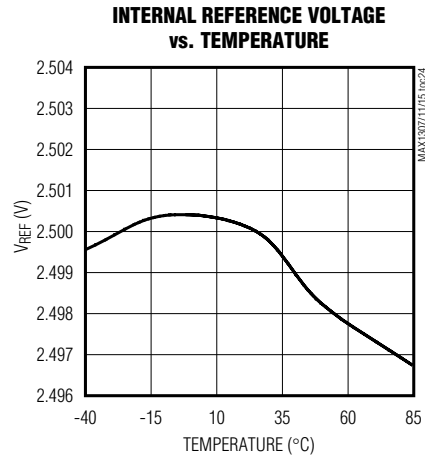
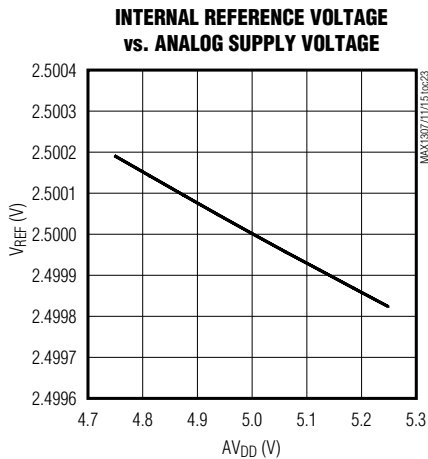
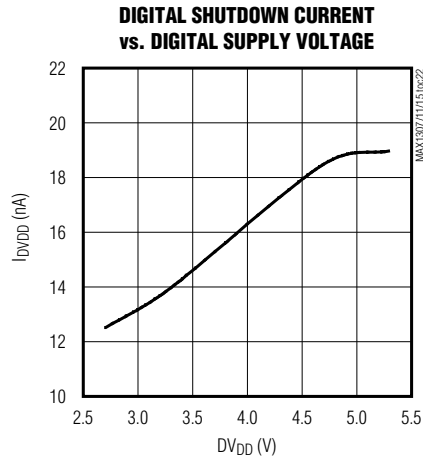
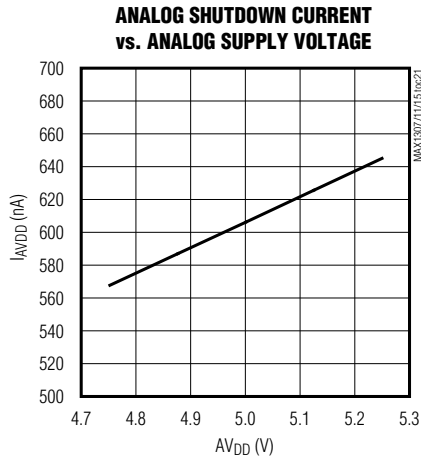
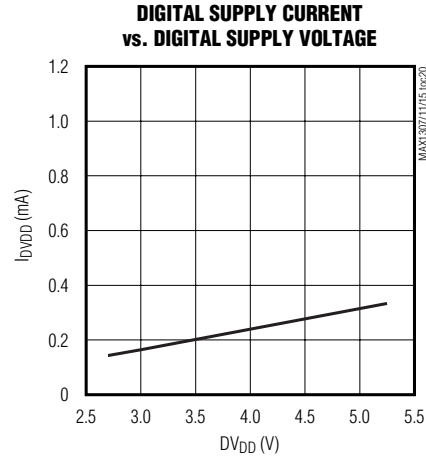
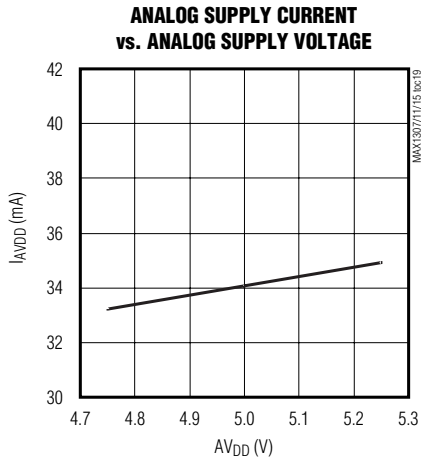

# 1075kps, 12-Bit, Parallel-Output ADCs with $\pm 10V$ , $\pm 5V$ , and 0 to +5V Analog Input Ranges

## Typical Operating Characteristics (continued)

( $AV_{DD} = +5V$ ,  $DV_{DD} = +3V$ ,  $AGND = DGND = 0$ ,  $V_{REF} = V_{REFMS} = +2.5V$  (external reference),  $C_{REF} = C_{REFMS} = 0.1\mu F$ ,  $C_{REF+} = C_{REF-} = 0.1\mu F$ ,  $C_{REF++to-REF-} = 2.2\mu F \parallel 0.1\mu F$ ,  $C_{COM} = 2.2\mu F \parallel 0.1\mu F$ ,  $C_{MSV} = 2.2\mu F \parallel 0.1\mu F$  (unipolar devices),  $MSV = AGND$  (bipolar devices),  $f_{CLK} = 16.67MHz$  50% duty cycle,  $INTCLK/EXTCLK = AGND$  (external clock),  $f_{IN} = 500kHz$ ,  $A_{IN} = -0.4dBFS$ .  $T_A = +25^\circ C$ , unless otherwise noted.) (Figures 3 and 4)

**INTERNAL CLOCK CONVERSION TIME vs. ANALOG SUPPLY VOLTAGE**

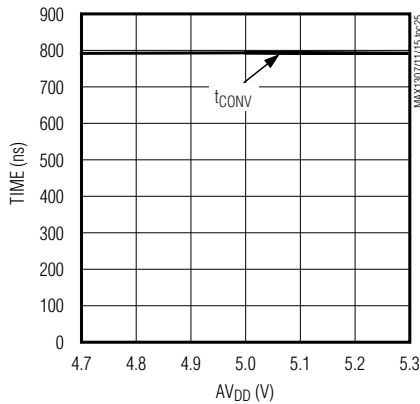

**INTERNAL CLOCK CONVERSION TIME vs. TEMPERATURE**

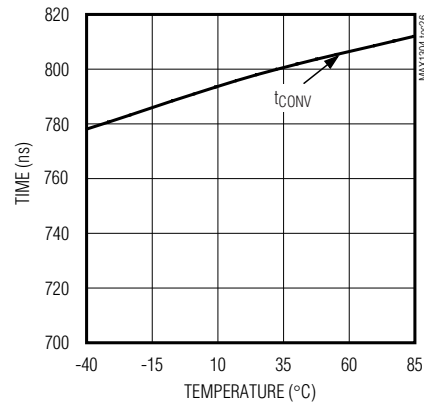

**ANALOG INPUT CHANNEL CURRENT vs. ANALOG INPUT CHANNEL VOLTAGE**

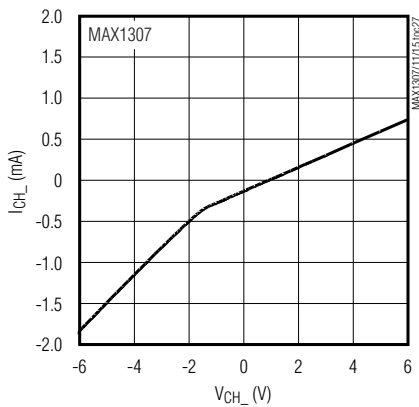

**ANALOG INPUT CHANNEL CURRENT vs. ANALOG INPUT CHANNEL VOLTAGE**

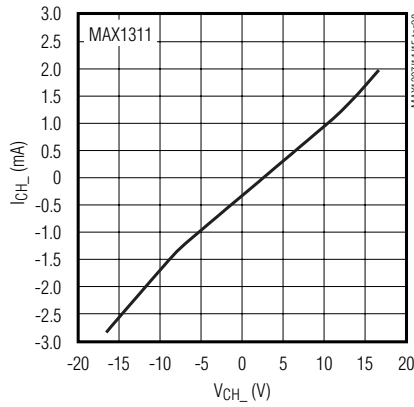

**ANALOG INPUT CHANNEL CURRENT vs. ANALOG INPUT CHANNEL VOLTAGE**

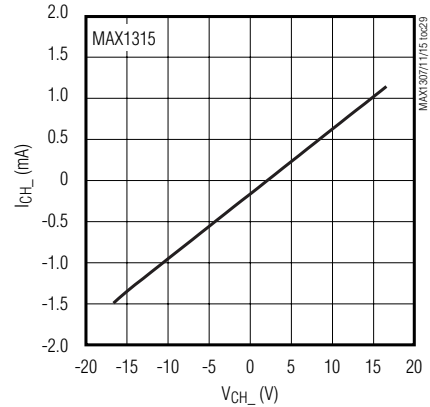

# 1075ksps, 12-Bit, Parallel-Output ADCs with $\pm 10V$ , $\pm 5V$ , and 0 to +5V Analog Input Ranges

## Pin Description

PIN	NAME	FUNCTION
1, 15, 17	AV <sub>DD</sub>	Analog Power Input. AV <sub>DD</sub> is the power input for the analog section of the converter. Apply +5V to AV <sub>DD</sub> . Connect all AV <sub>DD</sub> pins together. See the <i>Layout, Grounding, and Bypassing</i> section for additional information.
2, 3, 14, 16, 23	AGND	Analog Ground. AGND is the power return for AV <sub>DD</sub> . Connect all AGND pins together.
4	A <sub>IN</sub>	Analog Input
6	MSV	Midscale Voltage Bypass. For the unipolar MAX1307, connect a 2.2 $\mu$ F and a 0.1 $\mu$ F capacitor from MSV to AGND. For the bipolar MAX1311/MAX1315, connect MSV to AGND.
13	INTCLK/ EXTCLK	Clock-Mode Select Input. Connect INTCLK/EXTCLK to AV <sub>DD</sub> to select the internal clock. Connect INTCLK/EXTCLK to AGND to use an external clock connected to CLK.
18	REF <sub>MS</sub>	Midscale Reference Bypass/Input. REF <sub>MS</sub> connects through a 5k $\Omega$ resistor to the internal +2.5V bandgap reference buffer. For the MAX1307 unipolar devices, V <sub>REFMS</sub> is the input to the unity-gain buffer that drives MSV. MSV sets the midpoint of the input voltage range. For internal reference operation, bypass REF <sub>MS</sub> with a $\geq 0.01\mu$ F capacitor to AGND. For external reference operation, drive REF <sub>MS</sub> with an external voltage from +2V to +3V. For the MAX1311/MAX1315 bipolar devices, connect REF <sub>MS</sub> to REF. For internal reference operation, bypass the REF <sub>MS</sub> /REF node with a $\geq 0.01\mu$ F capacitor to AGND. For external reference operation, drive the REF <sub>MS</sub> /REF node with an external voltage from +2V to +3V.
19	REF	ADC Reference Bypass/Input. REF connects through a 5k $\Omega$ resistor to the internal +2.5V bandgap reference buffer. For internal reference operation, bypass REF with a $\geq 0.01\mu$ F capacitor. For external reference operation with the MAX1307 unipolar devices, drive REF with an external voltage from +2V to +3V. For external reference operation with the MAX1311/MAX1315 bipolar devices, connect REF <sub>MS</sub> to REF and drive the REF <sub>MS</sub> /REF node with an external voltage from +2V to +3V.
20	REF+	Positive Reference Bypass. Bypass REF+ with a 0.1 $\mu$ F capacitor to AGND. Also bypass REF+ to REF- with a 2.2 $\mu$ F and a 0.1 $\mu$ F capacitor. $V_{REF+} = V_{COM} + V_{REF} / 2$ .
21	COM	Reference Common Bypass. Bypass COM to AGND with a 2.2 $\mu$ F and a 0.1 $\mu$ F capacitor. $V_{COM} = 13 / 25 \times AV_{DD}$ .
22	REF-	Negative Reference Bypass. Bypass REF- with a 0.1 $\mu$ F capacitor to AGND. Also bypass REF- to REF+ with a 2.2 $\mu$ F and a 0.1 $\mu$ F capacitor. $V_{REF+} = V_{COM} - V_{REF} / 2$ .
24, 39	DGND	Digital Ground. DGND is the power return for DV <sub>DD</sub> . Connect all DGND pins together.
25, 38	DV <sub>DD</sub>	Digital Power Input. DV <sub>DD</sub> powers the digital section of the converter, including the parallel interface. Apply +2.7V to +5.25V to DV <sub>DD</sub> . Bypass DV <sub>DD</sub> to DGND with a 0.1 $\mu$ F capacitor. Connect all DV <sub>DD</sub> pins together.
26	D0	Digital Output 0 of 12-Bit Parallel Data Bus. High impedance when $\overline{RD} = 1$ or $\overline{CS} = 1$ .
27	D1	Digital Output 1 of 12-Bit Parallel Data Bus. High impedance when $\overline{RD} = 1$ or $\overline{CS} = 1$ .
28	D2	Digital Output 2 of 12-Bit Parallel Data Bus. High impedance when $\overline{RD} = 1$ or $\overline{CS} = 1$ .
29	D3	Digital Output 3 of 12-Bit Parallel Data Bus. High impedance when $\overline{RD} = 1$ or $\overline{CS} = 1$ .
30	D4	Digital Output 4 of 12-Bit Parallel Data Bus. High impedance when $\overline{RD} = 1$ or $\overline{CS} = 1$ .
31	D5	Digital Output 5 of 12-Bit Parallel Data Bus. High impedance when $\overline{RD} = 1$ or $\overline{CS} = 1$ .

# 1075ksps, 12-Bit, Parallel-Output ADCs with $\pm 10V$ , $\pm 5V$ , and 0 to +5V Analog Input Ranges

## Pin Description (continued)

PIN	NAME	FUNCTION
32	D6	Digital Output 6 of 12-Bit Parallel Data Bus. High impedance when $\overline{RD} = 1$ or $\overline{CS} = 1$ .
33	D7	Digital Output 7 of 12-Bit Parallel Data Bus. High impedance when $\overline{RD} = 1$ or $\overline{CS} = 1$ .
34	D8	Digital Output 8 of 12-Bit Parallel Data Bus. High impedance when $\overline{RD} = 1$ or $\overline{CS} = 1$ .
35	D9	Digital Output 9 of 12-Bit Parallel Data Bus. High impedance when $\overline{RD} = 1$ or $\overline{CS} = 1$ .
36	D10	Digital Output 10 of 12-Bit Parallel Data Bus. High impedance when $\overline{RD} = 1$ or $\overline{CS} = 1$ .
37	D11	Digital Output 11 of 12-Bit Parallel Data Bus. High impedance when $\overline{RD} = 1$ or $\overline{CS} = 1$ .
40	$\overline{EOC}$	End-of-Conversion Output. $\overline{EOC}$ goes low to indicate the end of a conversion. It returns high on the next rising CLK edge or the falling CONVST edge.
41	$\overline{EOLC}$	End-of-Last-Conversion Output. $\overline{EOLC}$ goes low to indicate the end of the last conversion. It returns high when CONVST goes low for the next conversion sequence.
42	$\overline{RD}$	Read Input. Pulling $\overline{RD}$ low initiates a read command of the parallel data bus.
43	$\overline{WR}$	Write Input. $\overline{WR}$ is not implemented. Connect $\overline{WR}$ to $\overline{RD}$ , $\overline{CS}$ , DGND, or DVDD.
44	$\overline{CS}$	Chip-Select Input. Pulling $\overline{CS}$ low activates the digital interface. Forcing $\overline{CS}$ high places D0–D11 in high-impedance mode.
45	CONVST	Conversion Start Input. Driving CONVST high initiates the conversion process. The analog inputs are sampled on the rising edge of CONVST.
46	CLK	External Clock Input. For external clock operation, connect INTCLK/EXTCLK to DGND and drive CLK with an external clock signal from 100kHz to 20MHz. For internal clock operation, connect INTCLK/EXTCLK to DVDD and connect CLK to DGND.
47	SHDN	Shutdown Input. Driving SHDN high initiates device shutdown. Connect SHDN to DGND for normal operation.
48	$\overline{CHSHDN}$	$\overline{CHSHDN}$ Is Not Implemented. Connect $\overline{CHSHDN}$ to DGND.
5, 7–12	I.C.	Internally Connected. Connect I.C. to AGND.

MAX1307/MAX1311/MAX1315

# 1075ksps, 12-Bit, Parallel-Output ADCs with $\pm 10V$ , $\pm 5V$ , and 0 to +5V Analog Input Ranges

## Detailed Description

The MAX1307/MAX1311/MAX1315 contain a 1075ksps 12-bit ADC with track and hold (T/H). Input scaling on the MAX1307/MAX1311/MAX1315 allows a 0 to +5V,  $\pm 5V$ , or  $\pm 10V$  analog input signal, respectively. Additionally, the MAX1307 features  $\pm 6V$  fault-tolerant inputs, while the MAX1311/MAX1315 feature  $\pm 16.5V$  fault-tolerant inputs. The MAX1307/MAX1311/MAX1315 include an on-chip +2.5V reference. These devices also accept an external +2V to +3V reference.

The conversion results are available in  $0.72\mu s$  with a sampling rate of 1075ksps. Internal or external clock capabilities offer greater flexibility. A high-speed, 20MHz parallel interface outputs the conversion results.

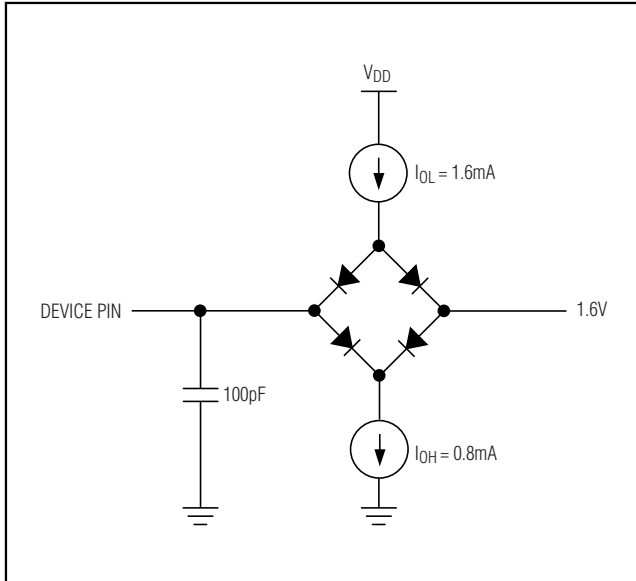

Figure 1. Digital Load Test Circuit

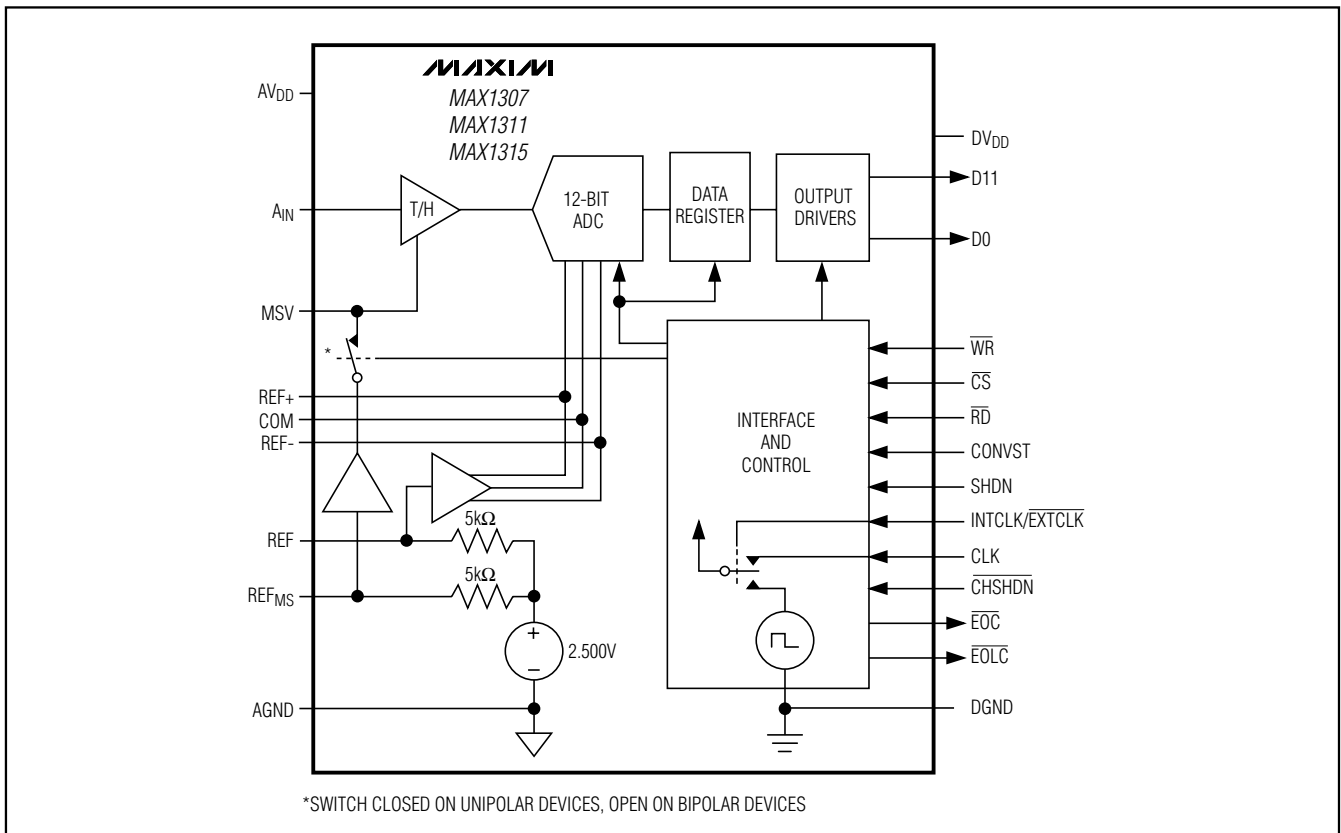

Figure 2. Functional Diagram

# 1075ksps, 12-Bit, Parallel-Output ADCs with $\pm 10V$ , $\pm 5V$ , and 0 to +5V Analog Input Ranges

MAX1307/MAX1311/MAX1315

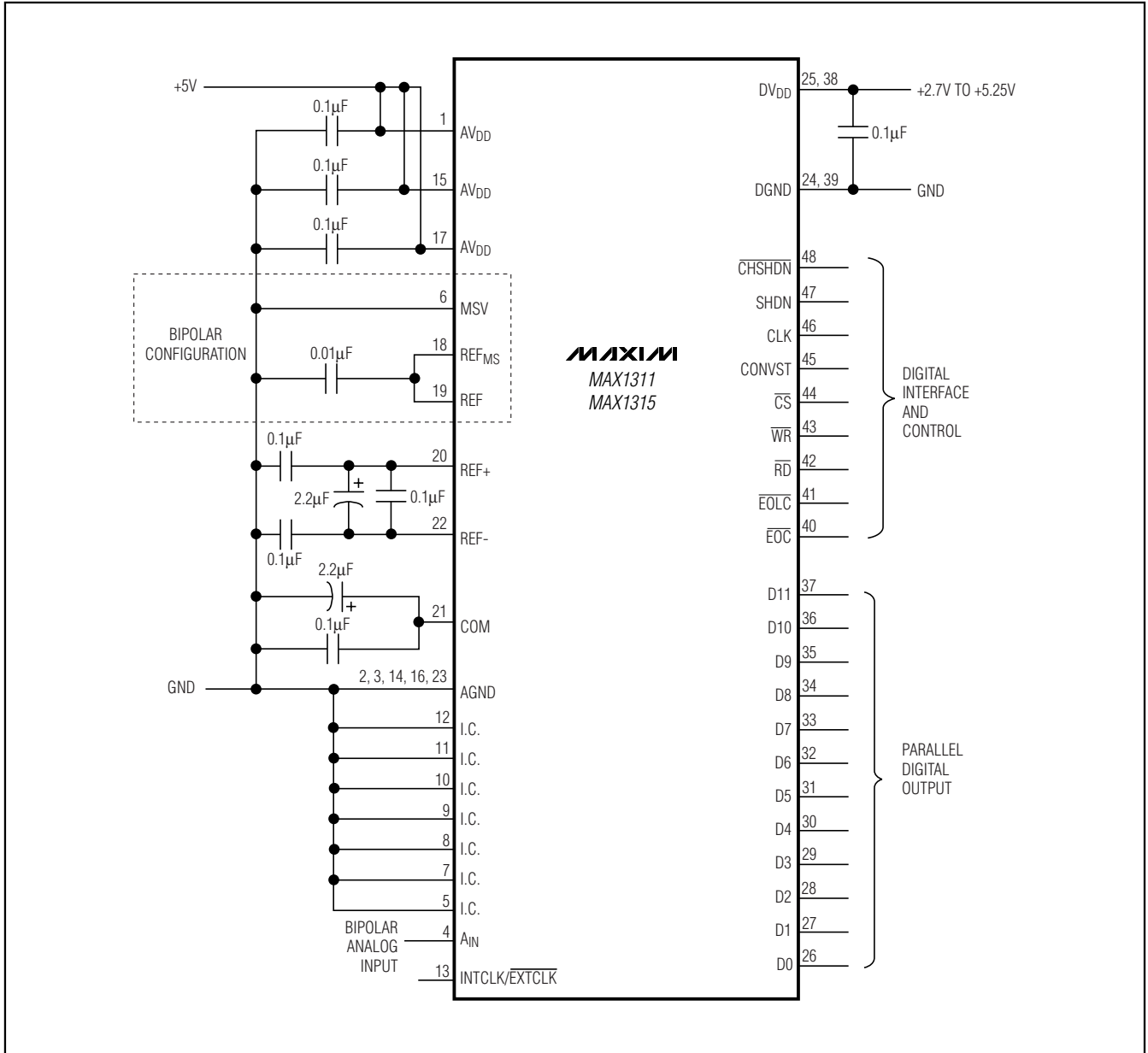

Figure 3. Typical Bipolar Operating Circuit

# 1075ksps, 12-Bit, Parallel-Output ADCs with $\pm 10V$ , $\pm 5V$ , and 0 to +5V Analog Input Ranges

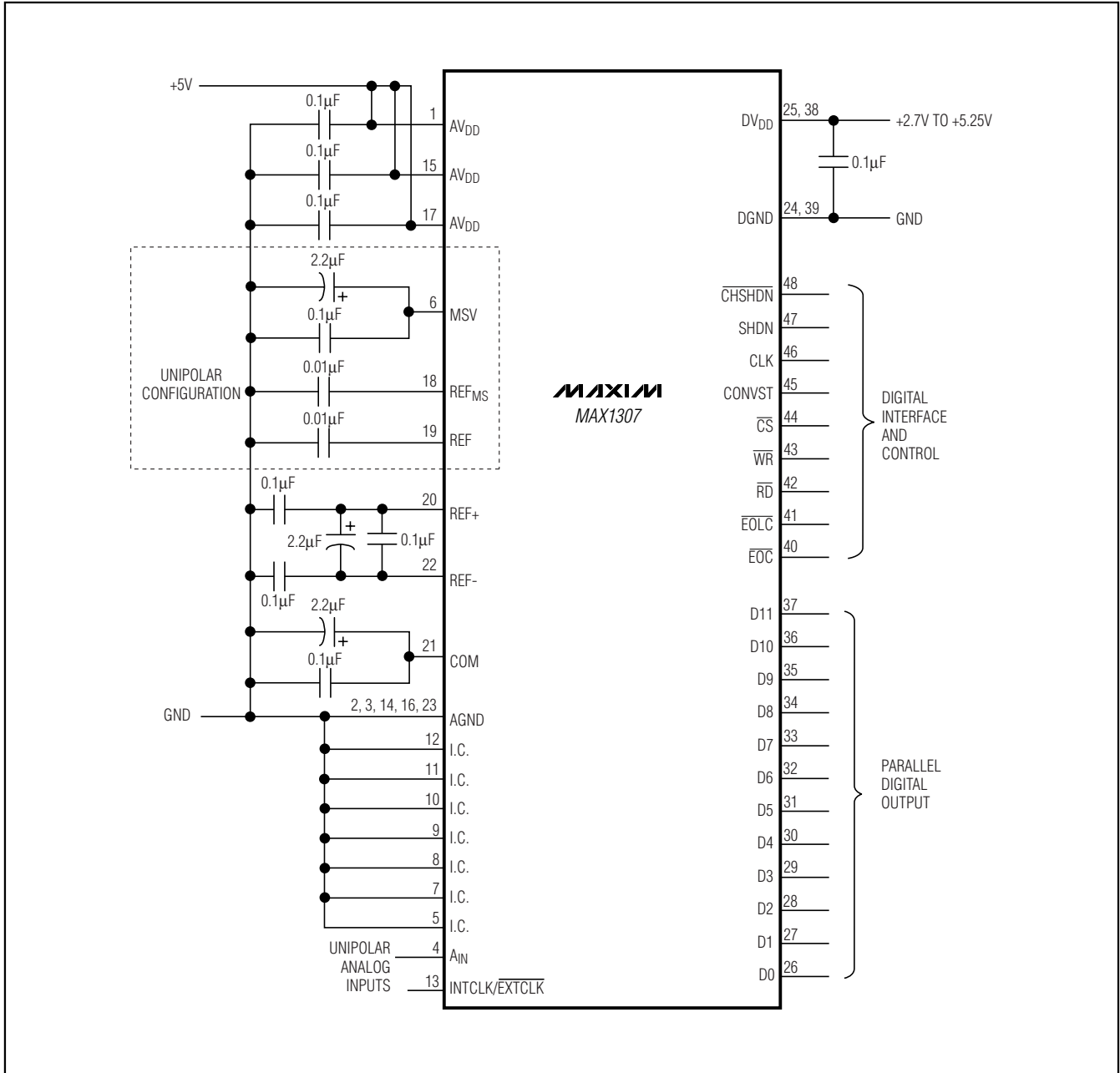

Figure 4. Typical Unipolar Operating Circuit



# 1075ksps, 12-Bit, Parallel-Output ADCs with $\pm 10V$ , $\pm 5V$ , and 0 to +5V Analog Input Ranges

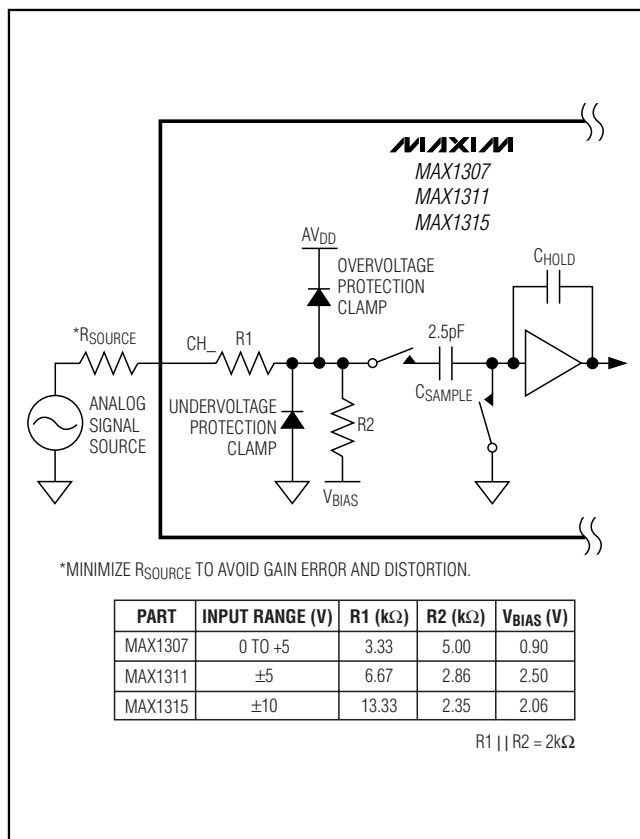

Figure 5. Equivalent Analog Input T/H Circuit

## Analog Input Track and Hold (T/H)

The input T/H circuit is controlled by the CONVST input. When CONVST is low, the T/H circuit tracks the analog input. When CONVST is high, the T/H circuit holds the analog input. The rising edge of CONVST is the analog input sampling instant. There is an aperture delay ( $t_{AD}$ ) of 8ns and a 50psRMS aperture jitter ( $t_{AJ}$ ).

To settle the charge on  $C_{SAMPLE}$  to 12-bit accuracy, use a minimum acquisition time ( $t_{ACQ}$ ) of 100ns. Therefore, CONVST must be low for at least 100ns. Although longer acquisition times allow the analog input to settle to its final value more accurately, the maximum acquisition time must be limited to 1ms. Accuracy with conversion times longer than 1ms cannot be guaranteed due to capacitor droop in the input circuitry.

Due to the analog input resistive divider formed by R1 and R2 in Figure 5, any significant analog input source resistance ( $R_{SOURCE}$ ) results in gain error. Furthermore,  $R_{SOURCE}$  causes distortion due to nonlinear analog input currents. Limit  $R_{SOURCE}$  to a maximum of 100Ω.

## Selecting an Input Buffer

To improve the input signal bandwidth under AC conditions, drive the input with a wideband buffer (>50MHz) that can drive the ADC's input capacitance (15pF) and settle quickly. For example, the MAX4431 or the MAX4265 can be used for 0 to +5V unipolar devices, or the MAX4350 can be used for  $\pm 5V$  bipolar inputs.

Most applications require an input buffer to achieve 12-bit accuracy. Although slew rate and bandwidth are important, the most critical input buffer specification is settling time. At the beginning of the acquisition, the ADC internal sampling capacitor array connects to the analog inputs, causing some disturbance. Ensure the amplifier is capable of settling to at least 12-bit accuracy during the acquisition time ( $t_{ACQ}$ ). Use a low-noise, low-distortion, wideband amplifier that settles quickly and is stable with the ADC's 15pF input capacitance.

Refer to the Maxim website at [www.maxim-ic.com](http://www.maxim-ic.com) for application notes on how to choose the optimum buffer amplifier for your ADC application.

## Input Bandwidth

The input-tracking circuitry has a 20MHz small-signal bandwidth, making it possible to digitize high-speed transient events and measure periodic signals with bandwidths exceeding the ADC's sampling rate by using undersampling techniques. To avoid high-frequency signals being aliased into the frequency band of interest, anti-alias filtering is recommended.

## Input Range and Protection

The MAX1307 provides a 0 to +5V input voltage range with fault protection of  $\pm 6V$ . The MAX1311 provides a  $\pm 5V$  input voltage range with fault protection of  $\pm 16.5V$ . The MAX1315 provides a  $\pm 10V$  input voltage range with fault protection of  $\pm 16.5V$ . Figure 5 shows the equivalent analog input circuit.

# 1075ksps, 12-Bit, Parallel-Output ADCs with $\pm 10V$ , $\pm 5V$ , and 0 to +5V Analog Input Ranges

## Data Throughput

The data throughput ( $f_{TH}$ ) of the MAX1307/MAX1311/MAX1315 is a function of the clock speed ( $f_{CLK}$ ). In internal clock mode,  $f_{CLK} = 15\text{MHz}$  (typ). In external clock mode, these devices accept an  $f_{CLK}$  between 100kHz and 20MHz. Figures 6 and 7 calculate  $f_{TH}$  as follows:

$$f_{TH} = \frac{1}{t_{ACQ} + t_{QUIET} + \frac{13}{f_{CLK}}}$$

where  $t_{QUIET}$  is the period of bus inactivity before the rising edge of CONVST ( $\geq 50\text{ns}$ ). See the *Starting a Conversion* section for more information.

## Clock Modes

The MAX1307/MAX1311/MAX1315 perform conversions using either an internal clock or external clock. There are 13 clock periods per conversion.

### Internal Clock

Internal clock mode frees the microprocessor from the burden of running the ADC conversion clock. For internal clock operation, connect INTCLK/EXTCLK to  $AV_{DD}$  and connect CLK to DGND. Note that INTCLK/EXTCLK is referenced to  $AV_{DD}$ , not  $DV_{DD}$ .

### External Clock

For external clock operation, connect INTCLK/EXTCLK to AGND and connect an external clock source to CLK. Note that INTCLK/EXTCLK is referenced to  $AV_{DD}$ , not  $DV_{DD}$ . The external clock frequency can be up to 20MHz. Linearity is not guaranteed with clock frequencies below 100kHz due to droop in the T/H circuits.

## Applications Information

### Digital Interface

Conversion results are available through the 12-bit digital interface (D0–D11). The interface includes the following control signals: chip select ( $\overline{CS}$ ), read ( $\overline{RD}$ ), end of conversion ( $\overline{EOC}$ ), end of last conversion ( $\overline{EOLC}$ ), conversion start (CONVST), shutdown (SHDN), internal clock select (INTCLK/EXTCLK), and external clock input (CLK). Figures 6 and 7 and the *Timing Characteristics* show the operation of the interface. D0–D11 go high impedance when  $\overline{RD} = 1$  or  $\overline{CS} = 1$ .

## Starting a Conversion

To start a conversion using internal clock mode, pull CONVST low for the acquisition time ( $t_{ACQ}$ ). The T/H acquires the signal while CONVST is low, and conversion begins on the rising edge of CONVST. The end-of-conversion ( $\overline{EOC}$ ) signal and end-of-last-conversion signal ( $\overline{EOLC}$ ) pulse low whenever a conversion result is available for reading (Figure 6).

To start a conversion using external clock mode, pull CONVST low for the acquisition time ( $t_{ACQ}$ ). The T/H acquires the signal while CONVST is low. The rising edge of CONVST is the sampling instant. Apply an external clock to CLK to start the conversion. To avoid T/H droop degrading the sampled analog input signals, the first CLK pulse must occur within  $10\mu\text{s}$  from the rising edge of CONVST. Additionally, the external clock frequency must be greater than 100kHz to avoid T/H droop degrading accuracy. The conversion result is available for read when  $\overline{EOC}$  or  $\overline{EOLC}$  goes low on the rising edge of the 13th clock cycle (Figure 7).

In both internal and external clock modes, hold CONVST high until the conversion result is read. If CONVST goes low in the middle of a conversion, the current conversion is aborted and a new conversion is initiated. Furthermore, there must be a period of bus inactivity ( $t_{QUIET}$ ) for 50ns or longer before the falling edge of CONVST for the specified ADC performance.

## Reading a Conversion Result

Figures 6 and 7 show the interface signals to initiate a read operation.  $\overline{CS}$  can be low at all times, low during the  $\overline{RD}$  cycles, or the same as  $\overline{RD}$ .

After initiating a conversion by bringing CONVST high, wait for  $\overline{EOC}$  or  $\overline{EOLC}$  to go low. In internal clock mode,  $\overline{EOC}$  or  $\overline{EOLC}$  goes low within 900ns. In external clock mode,  $\overline{EOC}$  or  $\overline{EOLC}$  goes low on the rising edge of the 13th CLK cycle. To read the conversion result, drive  $\overline{CS}$  and  $\overline{RD}$  low to latch data to the parallel digital output bus. Bring  $\overline{RD}$  high to release the digital bus.

# 1075kps, 12-Bit, Parallel-Output ADCs with $\pm 10V$ , $\pm 5V$ , and 0 to +5V Analog Input Ranges

MAX1307/MAX1311/MAX1315

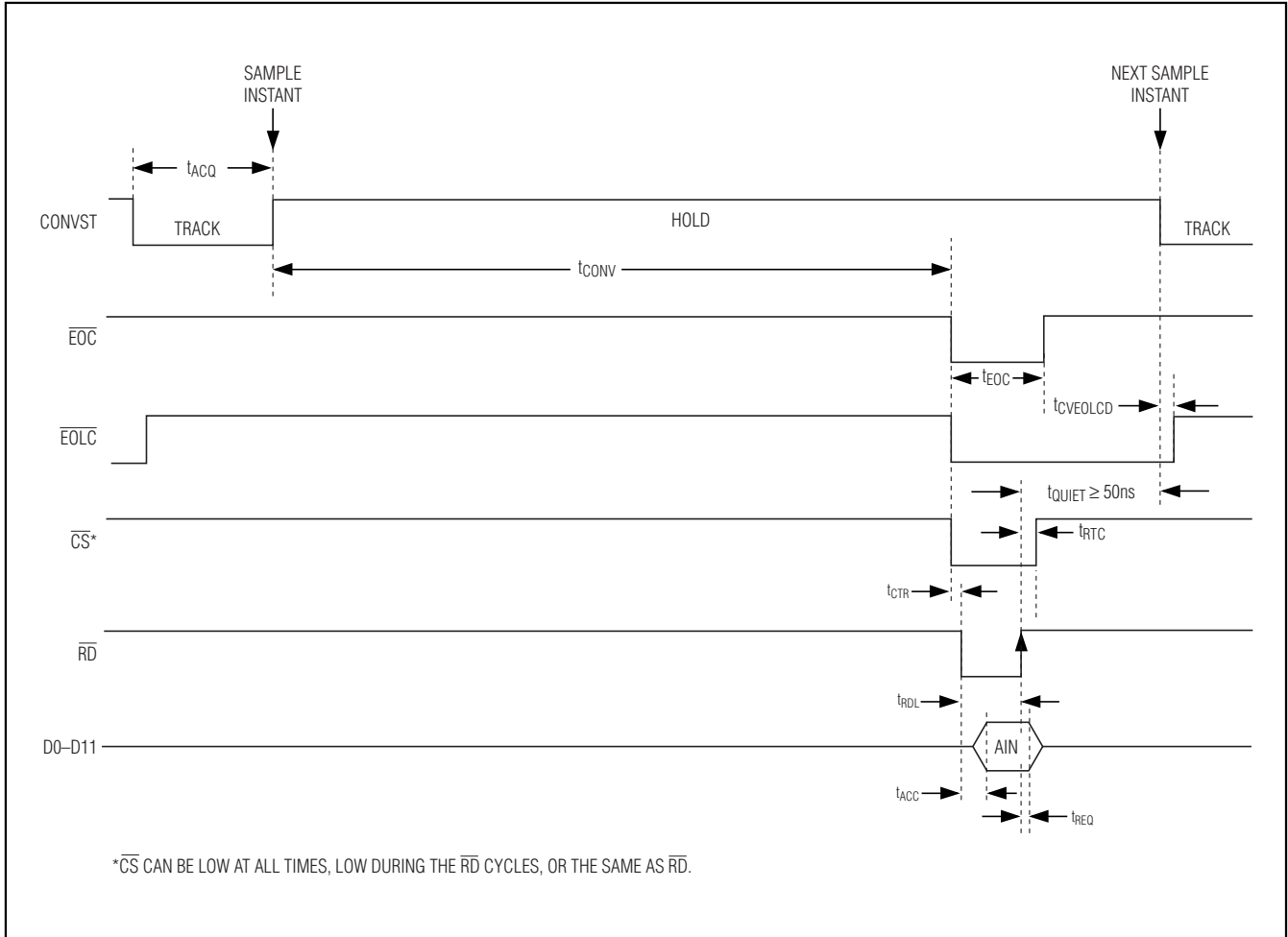

Figure 6. Reading a Conversion—Internal Clock

### Power-Up Reset

After applying power, allow a 1ms wake-up time to elapse and then initiate a conversion and discard the results. After the conversion is complete, accurate conversions can be obtained.

### Shutdown Modes

During shutdown the internal reference and analog circuits in the device shutdown and the analog supply current drops to 0.6 $\mu$ A (typ). Set SHDN high to enter shutdown mode.

$\overline{EOC}$  and  $\overline{EOLC}$  are high when the MAX1307/MAX1311/MAX1315 are shut down.

The state of the digital outputs D0–D11 is independent of the state of SHDN. If  $\overline{CS}$  and  $\overline{RD}$  are low, the digital outputs D0–D11 are active regardless of SHDN. The digital outputs only go high impedance when  $\overline{CS}$  or  $\overline{RD}$  is high. When the digital outputs are powered down, the digital supply current drops to 20nA.

Exiting shutdown (falling edge of SHDN) starts a conversion in the same way as the rising edge of CONVST. After coming out of shutdown, initiate a conversion and discard the results. Allow a 1ms wake-up time to expire before initiating the first accurate conversion.

# 1075kps, 12-Bit, Parallel-Output ADCs with $\pm 10V$ , $\pm 5V$ , and 0 to +5V Analog Input Ranges

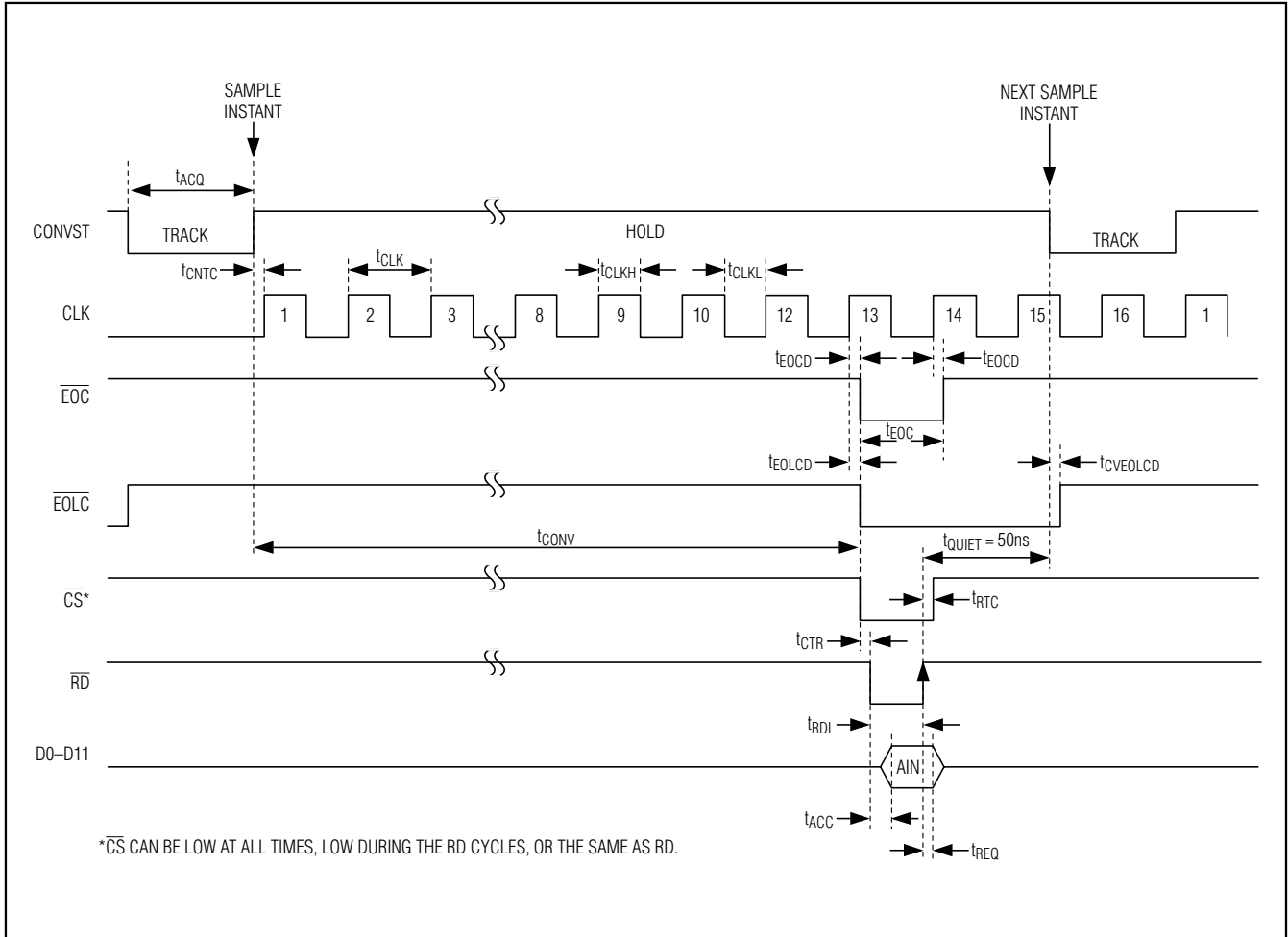

Figure 7. Reading a Conversion—External Clock

# 1075ksps, 12-Bit, Parallel-Output ADCs with ±10V, ±5V, and 0 to +5V Analog Input Ranges

## Reference

### Internal Reference

The internal reference circuits provide for analog input voltages of 0 to +5V for the unipolar MAX1307, ±5V for the bipolar MAX1311, or ±10V for the bipolar MAX1315. Install external capacitors for reference stability, as indicated in Table 1 and shown in Figures 3 and 4.

As illustrated in Figure 2, the internal reference voltage is 2.5V ( $V_{REF}$ ). This 2.5V is internally buffered to create the voltages at REF+ and REF-. Table 2 shows the voltages at COM, REF+, and REF-.

### External Reference

External reference operation is achieved by overriding the internal reference voltage. Override the internal reference voltage by driving REF with a +2.0V to +3.0V external reference. As shown in Figure 2, the REF input impedance is 5kΩ. For more information about using external references, see the *Transfer Functions* section.

## Midscale Voltage (MSV)

The voltage at MSV ( $V_{MSV}$ ) sets the midpoint of the ADC transfer functions. For the 0 to +5V input range (unipolar devices), the midpoint of the transfer function is +2.5V. For the ±5V and ±10V input range devices, the midpoint of the transfer function is zero.

As shown in Figure 2, there is a unity-gain buffer between REF<sub>MS</sub> and MSV in the unipolar MAX1307. This midscale buffer sets the midpoint of the unipolar transfer functions to either the internal +2.5V reference or an externally applied voltage at REF<sub>MS</sub>.  $V_{MSV}$  follows  $V_{REFMS}$  within ±3mV.

The midscale buffer is not active for the bipolar devices. For these devices, MSV must be connected to AGND or externally driven. REF<sub>MS</sub> must be bypassed with a 0.01μF capacitor to AGND.

See the *Transfer Functions* section for more information about MSV.

**Table 1. Reference Bypass Capacitors**

LOCATION	INPUT VOLTAGE RANGE	
	UNIPOLAR (μF)	BIPOLAR (μF)
MSV Bypass Capacitor to AGND	2.2    0.1	N/A
REF <sub>MS</sub> Bypass Capacitor to AGND	0.01	0.01
REF Bypass Capacitor to AGND	0.01	0.01
REF+ Bypass Capacitor to AGND	0.1	0.1
REF+ to REF- Capacitor	2.2    0.1	2.2    0.1
REF- Bypass Capacitor to AGND	0.1	0.1
COM Bypass Capacitor to AGND	2.2    0.1	2.2    0.1

N/A = Not applicable. Connect MSV directly to AGND.

**Table 2. Reference Voltages**

PARAMETER	EQUATION	CALCULATED VALUE (V) ( $V_{REF} = 2.000V,$ $AV_{DD} = 5.0V$ )	CALCULATED VALUE (V) ( $V_{REF} = 2.500V,$ $AV_{DD} = 5.0V$ )	CALCULATED VALUE (V) ( $V_{REF} = 3.000V,$ $AV_{DD} = 5.0V$ )
$V_{COM}$	$V_{COM} = 13 / 25 \times AV_{DD}$	2.600	2.600	2.600
$V_{REF+}$	$V_{REF+} = V_{COM} + V_{REF} / 2$	3.600	3.850	4.100
$V_{REF-}$	$V_{REF-} = V_{COM} - V_{REF} / 2$	1.600	1.350	1.100
$V_{REF+} - V_{REF-}$	$V_{REF} = V_{REF-} - V_{REF+}$	2.000	2.500	3.000

# 1075kps, 12-Bit, Parallel-Output ADCs with ±10V, ±5V, and 0 to +5V Analog Input Ranges

## Transfer Functions

### Unipolar 0 to +5V Devices

Table 3 and Figure 8 show the offset binary transfer function for the MAX1307 with a 0 to +5V input range. The full-scale input range (FSR) is two times the voltage at REF. The internal +2.5V reference gives a +5V FSR, while an external +2V to +3V reference allows an FSR of +4V to +6V, respectively. Calculate the LSB size using:

$$1 \text{ LSB} = \frac{2 \times V_{\text{REF}}}{2^{12}}$$

which equals 1.22mV when using a 2.5V reference.

**Table 3. 0 to 5V Unipolar Code Table**

BINARY DIGITAL OUTPUT CODE	DECIMAL EQUIVALENT DIGITAL OUTPUT CODE (CODE <sub>10</sub> )	INPUT VOLTAGE (V) ( $V_{\text{REF}} = +2.5\text{V}$ $V_{\text{REFMS}} = +2.5\text{V}$ )
1111 1111 1111 = 0xFFF	4095	+4.9994 ± 0.5 LSB
1111 1111 1110 = 0xFFE	4094	+4.9982 ± 0.5 LSB
1000 0000 0001 = 0x801	2049	+2.5018 ± 0.5 LSB
1000 0000 0000 = 0x800	2048	+2.5006 ± 0.5 LSB
0111 1111 1111 = 0x7FF	2047	+2.4994 ± 0.5 LSB
0000 0000 0001 = 0x001	1	+0.0018 ± 0.5 LSB
0000 0000 0000 = 0x000	0	+0.0006 ± 0.5 LSB

The input range is centered about  $V_{\text{MSV}}$ , internally set to +2.5V. For a custom midscale voltage, drive  $\text{REF}_{\text{MS}}$  with an external voltage source and  $\text{MSV}$  will follow  $\text{REF}_{\text{MS}}$ . Noise present on  $\text{MSV}$  or  $\text{REF}_{\text{MS}}$  directly couples into the ADC result. Use a precision, low-drift voltage reference with adequate bypassing to prevent  $\text{MSV}$  from degrading ADC performance. For maximum FSR, do not violate the absolute maximum voltage ratings of the analog inputs when choosing  $\text{MSV}$ .

Determine the input voltage as a function of  $V_{\text{REF}}$ ,  $V_{\text{MSV}}$ , and the output code in decimal using:

$$V_{\text{CH}_-} = \text{LSB} \times \text{CODE}_{10} + V_{\text{MSV}} - 2.500\text{V}$$

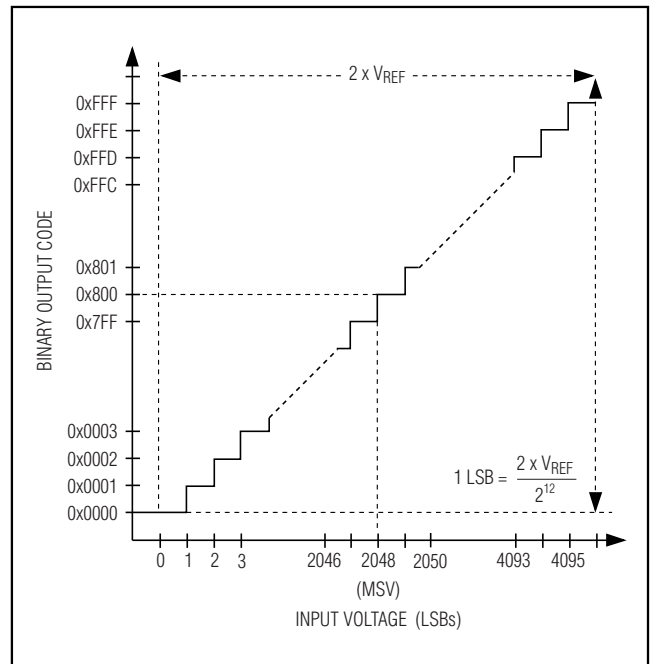

Figure 8. 0 to +5V Unipolar Transfer Function

# 1075ksps, 12-Bit, Parallel-Output ADCs with $\pm 10V$ , $\pm 5V$ , and 0 to +5V Analog Input Ranges

## Bipolar $\pm 5V$ Devices

Table 4 and Figure 9 show the two's complement transfer function for the  $\pm 5V$  input range MAX1311. The FSR is four times the voltage at REF. The internal +2.5V reference gives a +10V FSR, while an external +2V to +3V reference allows an FSR of +8V to +12V respectively. Calculate the LSB size using:

$$1 \text{ LSB} = \frac{4 \times V_{REF}}{2^{12}}$$

which equals 2.44mV when using a 2.5V reference.

The input range is centered about  $V_{MSV}$ . Normally,  $MSV = AGND$ , and the input is symmetrical about zero. For a custom midscale voltage, drive  $MSV$  with an external voltage source. Noise present on  $MSV$  directly couples into the ADC result. Use a precision, low-drift voltage reference with adequate bypassing to prevent  $MSV$  from degrading ADC performance. For maximum FSR, do not violate the absolute maximum voltage ratings of the analog inputs when choosing  $MSV$ .

Determine the input voltage as a function of  $V_{REF}$ ,  $V_{MSV}$ , and the output code in decimal using:

$$V_{CH\_} = \text{LSB} \times \text{CODE}_{10} + V_{MSV}$$

**Table 4.  $\pm 5V$  Bipolar Code Table**

TWO's COMPLEMENT DIGITAL OUTPUT CODE	DECIMAL EQUIVALENT DIGITAL OUTPUT CODE (CODE <sub>10</sub> )	INPUT VOLTAGE (V) ( $V_{REF} = +2.5V$ , $V_{MSV} = 0$ )
0111 1111 1111 = 0x7FF	+2047	+4.9988 $\pm$ 0.5 LSB
0111 1111 1110 = 0x7FE	+2046	+4.9963 $\pm$ 0.5 LSB
0000 0000 0001 = 0x001	+1	+0.0037 $\pm$ 0.5 LSB
0000 0000 0000 = 0x000	0	+0.0012 $\pm$ 0.5 LSB
1111 1111 1111 = 0xFFFF	-1	-0.0012 $\pm$ 0.5 LSB
1000 0000 0001 = 0x801	-2047	-4.9963 $\pm$ 0.5 LSB
1000 0000 0000 = 0x800	-2048	-4.9988 $\pm$ 0.5 LSB

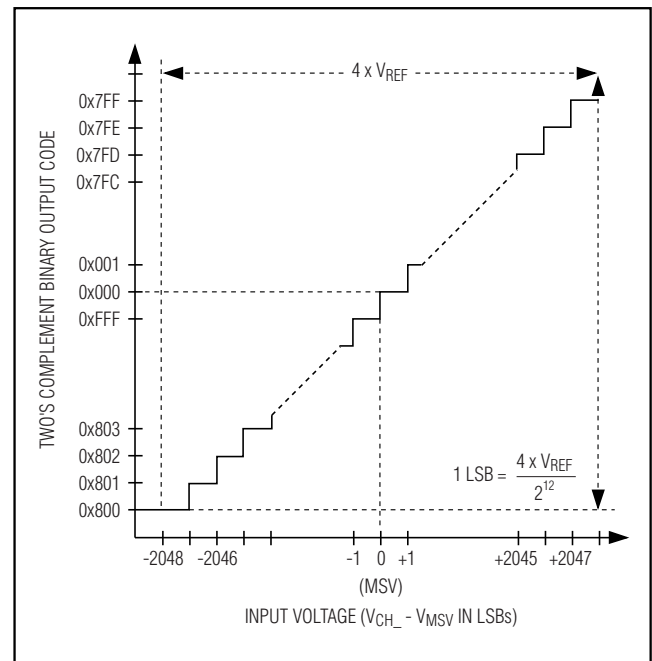

Figure 9.  $\pm 5V$  Bipolar Transfer Function

# 1075kps, 12-Bit, Parallel-Output ADCs with ±10V, ±5V, and 0 to +5V Analog Input Ranges

## Bipolar ±10V Devices

Table 5 and Figure 10 show the two's complement transfer function for the ±10V input range MAX1315. The FSR is eight times the voltage at REF. The internal +2.5V reference gives a +20V FSR, while an external +2V to +3V reference allows an FSR of +16V to +24V, respectively. Calculate the LSB size using:

$$1 \text{ LSB} = \frac{8 \times V_{REF}}{2^{12}}$$

which equals 4.88mV with a +2.5V internal reference.

**Table 5. ±10V Bipolar Code Table**

TWO's COMPLEMENT DIGITAL OUTPUT CODE	DECIMAL EQUIVALENT DIGITAL OUTPUT CODE (CODE <sub>10</sub> )	INPUT VOLTAGE (V) (V <sub>REF</sub> = +2.5V, V <sub>MSV</sub> = 0)
0111 1111 1111 = 0x7FF	+2047	+9.9976 ± 0.5 LSB
0111 1111 1110 = 0x7FE	+2046	+9.9927 ± 0.5 LSB
0000 0000 0001 = 0x001	+1	+0.0073 ± 0.5 LSB
0000 0000 0000 = 0x000	0	0.0024 ± 0.5 LSB
1111 1111 1111 = 0xFFF	-1	-0.0024 ± 0.5 LSB
1000 0000 0001 = 0x801	-2047	-9.9927 ± 0.5 LSB
1000 0000 0000 = 0x800	-2048	-9.9976 ± 0.5 LSB

The input range is centered about V<sub>MSV</sub>. Normally, MSV = AGND, and the input is symmetrical about zero. For a custom midscale voltage, drive MSV with an external voltage source. Noise present on MSV directly couples into the ADC result. Use a precision, low-drift voltage reference with adequate bypassing to prevent MSV from degrading ADC performance. For maximum FSR, do not violate the absolute maximum voltage ratings of the analog inputs when choosing MSV.

Determine the input voltage as a function of V<sub>REF</sub>, V<sub>MSV</sub>, and the output code in decimal using:

$$V_{CH\_} = \text{LSB} \times \text{CODE}_{10} + V_{MSV}$$

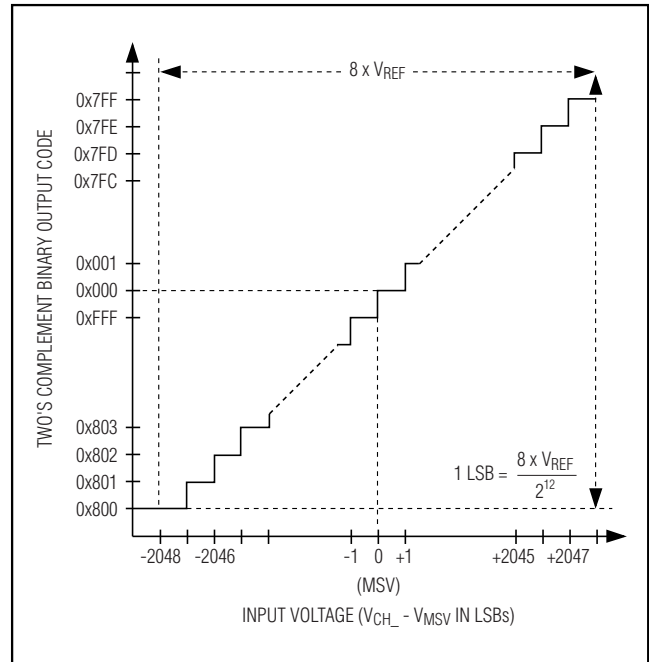

Figure 10. ±10V Bipolar Transfer Function



# 1075ksps, 12-Bit, Parallel-Output ADCs with $\pm 10V$ , $\pm 5V$ , and 0 to +5V Analog Input Ranges

## Layout, Grounding, and Bypassing

For best performance use PC boards. Board layout must ensure that digital and analog signal lines are separated from each other. Do not run analog and digital lines parallel to one another (especially clock lines), and do not run digital lines underneath the ADC package.

Figure 11 shows the recommended system ground connections. Establish an analog ground point at AGND and a digital ground point at DGND. Connect all analog grounds to the analog ground point. Connect all digital grounds to the digital ground point. For lowest-noise operation, make the power-supply ground returns as low impedance and as short as possible. Connect the analog ground point to the digital ground point at one location.

High-frequency noise in the power supplies degrades the ADC's performance. Bypass the analog power plane to the analog ground plane with a 2.2 $\mu$ F capacitor within one inch of the device. Bypass each AV<sub>DD</sub> to AGND pair of pins with a 0.1 $\mu$ F capacitor as close to the device as possible. AV<sub>DD</sub> to AGND pairs are pin 1 to pin 2, pin 14 to pin 15, and pin 16 to pin 17. Likewise, bypass the digital power plane to the digital ground plane with a 2.2 $\mu$ F capacitor within one inch of the device. Bypass each DV<sub>DD</sub> to DGND pair of pins with a 0.1 $\mu$ F capacitor as close to the device as possible. DV<sub>DD</sub> to DGND pairs are pin 24 to pin 25, and pin 38 to pin 39. If a supply is very noisy use a ferrite bead as a lowpass filter as shown in Figure 11.

## Definitions

### Integral Nonlinearity (INL)

INL is the deviation of the values on an actual transfer function from a straight line. For these devices, this straight line is drawn between the end points of the transfer function, once offset and gain errors have been nullified.

### Differential Nonlinearity (DNL)

DNL is the difference between an actual step width and the ideal value of 1 LSB. For these devices, the DNL of each digital output code is measured and the worst-case value is reported in the *Electrical Characteristics* table. A DNL error specification of less than  $\pm 1$  LSB guarantees no missing codes and a monotonic transfer function.

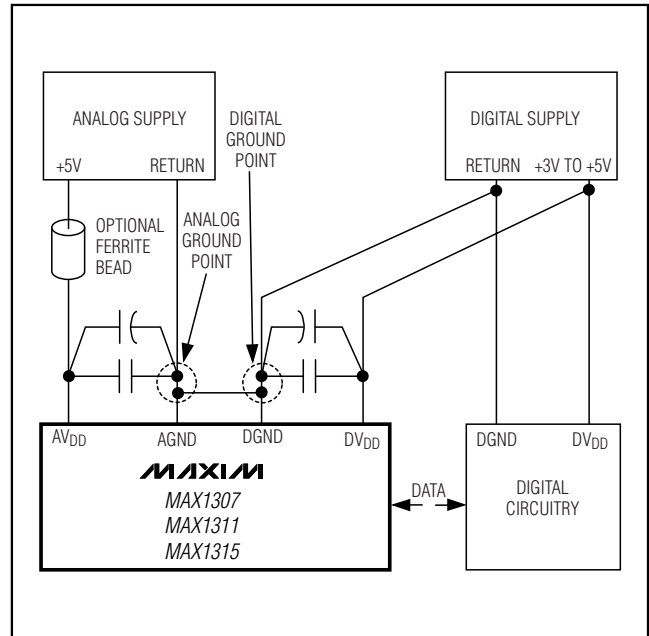

Figure 11. Power-Supply Grounding and Bypassing

### Offset Error

Offset error is a figure of merit that indicates how well the actual transfer function matches the ideal transfer function at a single point. Typically, the point at which offset error is specified is either at or near the zero-scale point of the transfer function or at or near the mid-scale point of the transfer function.

For the unipolar devices (MAX1307), the ideal zero-scale transition from 0x000 to 0x001 occurs at 1 LSB above AGND (Figure 8, Table 3). Unipolar offset error is the amount of deviation between the measured zero-scale transition point and the ideal zero-scale transition point.

For the bipolar devices (MAX1311/MAX1315), the ideal midscale transition from 0xFF to 0x000 occurs at MSV (Figures 9 and 10, Tables 4 and 5). The bipolar offset error is the amount of deviation between the measured midscale transition point and the ideal midscale transition point.

# 1075ksps, 12-Bit, Parallel-Output ADCs with $\pm 10V$ , $\pm 5V$ , and 0 to +5V Analog Input Ranges

## Gain Error

Gain error is a figure of merit that indicates how well the slope of the actual transfer function matches the slope of the ideal transfer function. For the MAX1307/MAX1311/MAX1315, the gain error is the difference of the measured full-scale and zero-scale transition points minus the difference of the ideal full-scale and zero-scale transition points.

For the unipolar devices (MAX1307), the full-scale transition point is from 0xFFE to 0xFFF and the zero-scale transition point is from 0x000 to 0x001.

For the bipolar devices (MAX1311/MAX1315), the full-scale transition point is from 0x7FE to 0x7FF and the zero-scale transition point is from 0x800 to 0x801.

## Signal-to-Noise Ratio (SNR)

For a waveform perfectly reconstructed from digital samples, the theoretical maximum SNR is the ratio of the full-scale analog input (RMS value) to the RMS quantization error (residual error). The ideal, theoretical minimum analog-to-digital noise is caused by quantization error only and results directly from the ADC's resolution (N bits):

$$\text{SNR}_{\text{dB}[\text{max}]} = 6.02\text{dB} \times N + 1.76\text{dB}$$

In reality, there are other noise sources such as thermal noise, reference noise, and clock jitter.

For these devices, SNR is computed by taking the ratio of the RMS signal to the RMS noise. RMS noise includes all spectral components to the Nyquist frequency excluding the fundamental, the first five harmonics, and the DC offset.

## Signal-to-Noise Plus Distortion (SINAD)

SINAD is computed by taking the ratio of the RMS signal to the RMS noise plus distortion. RMS noise plus distortion includes all spectral components to the Nyquist frequency excluding the fundamental and the DC offset.

$$\text{SINAD}(\text{dB}) = 20 \times \log \left( \frac{\text{Signal}_{\text{RMS}}}{\sqrt{\text{Noise}_{\text{RMS}}^2 + \text{Distortion}_{\text{RMS}}^2}} \right)$$

## Effective Number of Bits (ENOB)

ENOB specifies the dynamic performance of an ADC at a specific input frequency and sampling rate. An ideal ADC's error consists of quantization noise only. ENOB for a full-scale sinusoidal input waveform is computed as:

$$\text{ENOB} = \frac{\text{SINAD} - 1.76}{6.02}$$

## Total Harmonic Distortion (THD)

THD is the ratio of the RMS sum of the first five harmonics to the fundamental itself. This is expressed as:

$$\text{THD} = 20 \times \log \left( \frac{\sqrt{V_2^2 + V_3^2 + V_4^2 + V_5^2 + V_6^2}}{V_1} \right)$$

where  $V_1$  is the fundamental amplitude, and  $V_2$  through  $V_6$  are the amplitudes of the 2nd- through 6th-order harmonics.

# 1075ksps, 12-Bit, Parallel-Output ADCs with $\pm 10V$ , $\pm 5V$ , and 0 to +5V Analog Input Ranges

## Spurious-Free Dynamic Range (SFDR)

SFDR is the ratio of the RMS amplitude of the fundamental (maximum signal component) to the RMS value of the next-largest spurious component, excluding DC offset. SFDR is specified in decibels relative to the carrier (dBc).

## Aperture Delay

Aperture delay ( $t_{AD}$ ) is the time delay from the CONVST rising edge to the instant when an actual sample is taken.

## Aperture Jitter

Aperture jitter ( $t_{AJ}$ ) is the sample-to-sample variation in aperture delay.

Jitter is a concern when considering an ADC's dynamic performance, e.g., SNR. To reconstruct an analog input from the ADC digital outputs, it is critical to know the time at which each sample was taken. Typical applications use an accurate sampling clock signal that has low jitter from sampling edge to sampling edge. For a system with a perfect sampling clock signal, with no clock jitter, the SNR performance of an ADC is limited by the ADC's internal aperture jitter as follows:

$$SNR = 20 \times \log \left( \frac{1}{2 \times \pi \times f_{IN} \times t_{AJ}} \right)$$

where  $f_{IN}$  represents the analog input frequency and  $t_{AJ}$  is the time of the aperture jitter.

## Small-Signal Bandwidth

A small -20dBFS analog input signal is applied to an ADC so that the signal's slew rate does not limit the ADC's performance. The input frequency is then swept up to the point where the amplitude of the digitized conversion result has decreased by -3dB.

## Full-Power Bandwidth

A large, -0.5dBFS analog input signal is applied to an ADC, and the input frequency is swept up to the point where the amplitude of the digitized conversion result has decreased by -3dB. This point is defined as full-power input bandwidth frequency.

## DC Power-Supply Rejection (PSRR)

DC PSRR is defined as the change in the positive full-scale transfer-function point caused by a  $\pm 5\%$  variation in the analog power-supply voltage ( $AV_{DD}$ ).

## Chip Information

TRANSISTOR COUNT: 50,000

PROCESS: 0.6 $\mu$ m BiCMOS

# 1075ksp/s, 12-Bit, Parallel-Output ADCs with ±10V, ±5V, and 0 to +5V Analog Input Ranges

## Package Information

(The package drawing(s) in this data sheet may not reflect the most current specifications. For the latest package outline information, go to [www.maxim-ic.com/packages](http://www.maxim-ic.com/packages).)

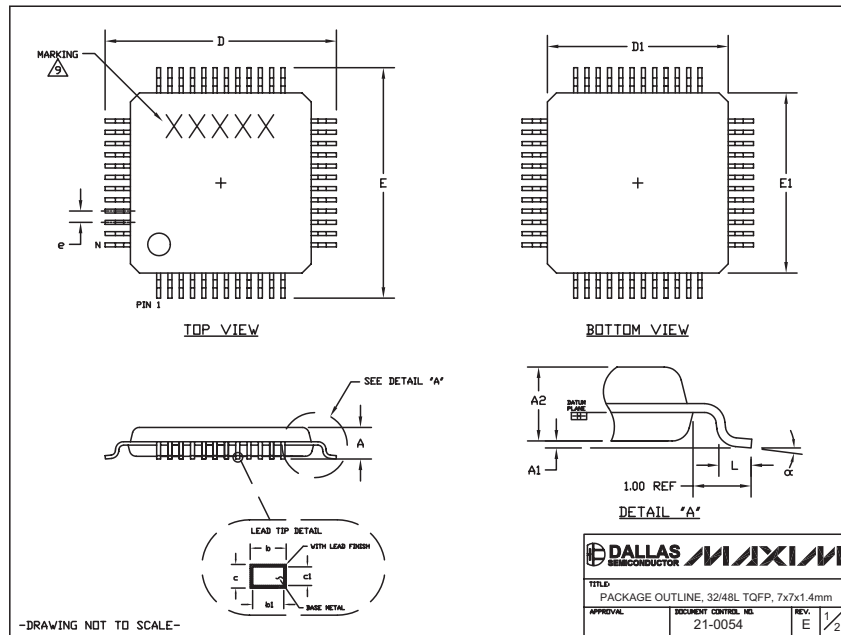

32/48L TOFP.EPS

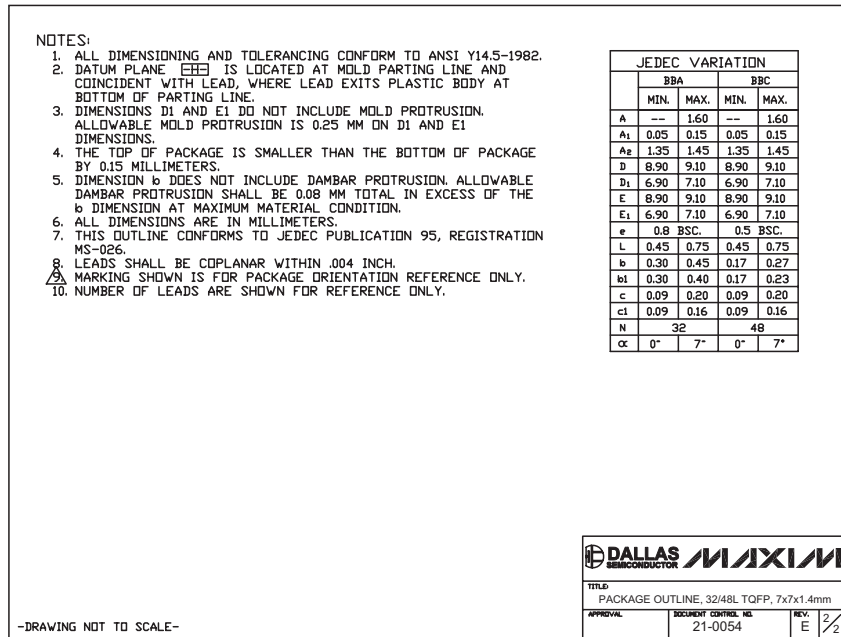

Maxim cannot assume responsibility for use of any circuitry other than circuitry entirely embodied in a Maxim product. No circuit patent licenses are implied. Maxim reserves the right to change the circuitry and specifications without notice at any time.

28 **Maxim Integrated Products, 120 San Gabriel Drive, Sunnyvale, CA 94086 408-737-7600**

SITE  
SEARCHPART NO.  
SEARCH

WHAT'S NEW

PRODUCTS

SOLUTIONS

DESIGN

APPNOTES

SUPPORT

BUY

COMPANY

MEMBERS

[Maxim](#) > [Products](#) > [Analog-to-Digital Converters](#)

# MAX1307, MAX1311, MAX1315

1075ksps, 12-Bit, Parallel-Output ADCs with 10V, 5V and 05V Analog Input Ranges

## Single-Channel Version of the MAX1304MAX1315 Family

[QuickView](#)[Technical Documents](#)[Ordering Info](#)[More Information](#)[All](#)

### Ordering Information

#### Notes:

- Other options and links for purchasing parts are listed at: <http://www.maxim-ic.com/sales>.
- [Didn't Find What You Need?](#) Ask our applications engineers. Expert assistance in finding parts, usually within one business day.
- Part number suffixes: T or T&R = tape and reel; + = RoHS/lead-free; # = RoHS/lead-exempt. More: See [Full Data Sheet](#) or [Part Naming Conventions](#).
- \* Some packages have variations, listed on the drawing. "PkgCode/Variation" tells which variation the product uses.

#### Devices: 1-12 of 12

MAX1307	Free Sample	Buy	Package: TYPE PINS FOOTPRINT DRAWING CODE/VAR *	Temp	RoHS/Lead-Free? Materials Analysis
MAX1307ECM+	<input type="checkbox"/>	<input type="checkbox"/>	LQFP;48 pin;83 mm Dwg: <a href="#">21-0054F</a> (PDF) Use pkgcode/variation: C48+6*	-40C to +85C	RoHS/Lead-Free: <a href="#">Lead Free Materials Analysis</a>
MAX1307ECM+T	<input type="checkbox"/>	<input type="checkbox"/>	LQFP;48 pin;83 mm Dwg: <a href="#">21-0054F</a> (PDF) Use pkgcode/variation: C48+6*	-40C to +85C	RoHS/Lead-Free: <a href="#">Lead Free Materials Analysis</a>
MAX1307ECM-T	<input type="checkbox"/>	<input type="checkbox"/>	LQFP;48 pin;83 mm Dwg: <a href="#">21-0054F</a> (PDF) Use pkgcode/variation: C48-6*	-40C to +85C	RoHS/Lead-Free: <a href="#">No Materials Analysis</a>
MAX1307ECM	<input type="checkbox"/>	<input type="checkbox"/>	LQFP;48 pin;83 mm Dwg: <a href="#">21-0054F</a> (PDF) Use pkgcode/variation: C48-6*	-40C to +85C	RoHS/Lead-Free: <a href="#">No Materials Analysis</a>
MAX1311	Free Sample	Buy	Package: TYPE PINS FOOTPRINT DRAWING CODE/VAR *	Temp	RoHS/Lead-Free? Materials Analysis
MAX1311ECM+	<input type="checkbox"/>	<input type="checkbox"/>	LQFP;48 pin;83 mm Dwg: <a href="#">21-0054F</a> (PDF) Use pkgcode/variation: C48+6*	-40C to +85C	RoHS/Lead-Free: <a href="#">Lead Free Materials Analysis</a>
MAX1311ECM+T	<input type="checkbox"/>	<input type="checkbox"/>	LQFP;48 pin;83 mm Dwg: <a href="#">21-0054F</a> (PDF) Use pkgcode/variation: C48+6*	-40C to +85C	RoHS/Lead-Free: <a href="#">Lead Free Materials Analysis</a>
MAX1311ECM	<input type="checkbox"/>	<input type="checkbox"/>	LQFP;48 pin;83 mm Dwg: <a href="#">21-0054F</a> (PDF) Use pkgcode/variation: C48-6*	-40C to +85C	RoHS/Lead-Free: <a href="#">No Materials Analysis</a>
MAX1311ECM-T	<input type="checkbox"/>	<input type="checkbox"/>	LQFP;48 pin;83 mm Dwg: <a href="#">21-0054F</a> (PDF) Use pkgcode/variation: C48-6*	-40C to +85C	RoHS/Lead-Free: <a href="#">No Materials Analysis</a>
MAX1315	Free Sample	Buy	Package: TYPE PINS FOOTPRINT DRAWING CODE/VAR *	Temp	RoHS/Lead-Free? Materials Analysis
MAX1315ECM+	<input type="checkbox"/>	<input type="checkbox"/>	LQFP;48 pin;83 mm Dwg: <a href="#">21-0054F</a> (PDF) Use pkgcode/variation: C48+6*	-40C to +85C	RoHS/Lead-Free: <a href="#">Lead Free Materials Analysis</a>
MAX1315ECM+T	<input type="checkbox"/>	<input type="checkbox"/>	LQFP;48 pin;83 mm Dwg: <a href="#">21-0054F</a> (PDF) Use pkgcode/variation: C48+6*	-40C to +85C	RoHS/Lead-Free: <a href="#">Lead Free Materials Analysis</a>

MAX1315ECM			LQFP;48 pin;83 mm Dwg: <a href="#">21-0054F (PDF)</a> Use pkgcode/variation: C48-6*	-40C to +85C	RoHS/Lead-Free: <a href="#">No Materials Analysis</a>
MAX1315ECM-T			LQFP;48 pin;83 mm Dwg: <a href="#">21-0054F (PDF)</a> Use pkgcode/variation: C48-6*	-40C to +85C	RoHS/Lead-Free: <a href="#">No Materials Analysis</a>

### Didn't Find What You Need?

- [Next Day Product Selection Assistance from Applications Engineers](#)
- [Parametric Search](#)
- [Applications Help](#)

#### QuickView

[Description](#)  
[Key Features](#)  
[Applications/Uses](#)  
 Key Specifications  
[Diagram](#)

#### Technical Documents

[Data Sheet](#)  
 Application Notes  
[Design Guides](#)  
 Engineering Journals  
[Reliability Reports](#)  
 Software/Models  
 Evaluation Kits

#### Ordering Info

Price and Availability  
 Samples  
 Buy Online  
 Package Information  
 Lead-Free Information

#### More Information

[Related Products](#)  
 Notes and Comments  
 Evaluation Kits

Document Ref.: 19-3481; Rev 0; 2005-12-15  
 This page last modified: 2007-07-30

[CONTACT US: SEND US AN EMAIL](#)