

Tous droits strictement réservés. Reproduction ou communication à des tiers interdite sous quelque forme que ce soit sans autorisation écrite du propriétaire. Propriété de FCI. Droits de reproduction FCI.

All rights strictly reserved. Reproduction or issue to third parties in any form whatever is not permitted without written authority from the proprietor. Property of FCI. Copyright FCI.

PRODUCT NO
SEE TABLE

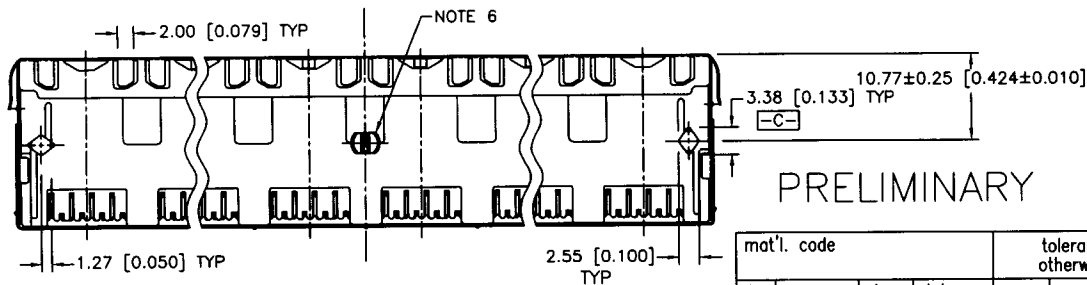
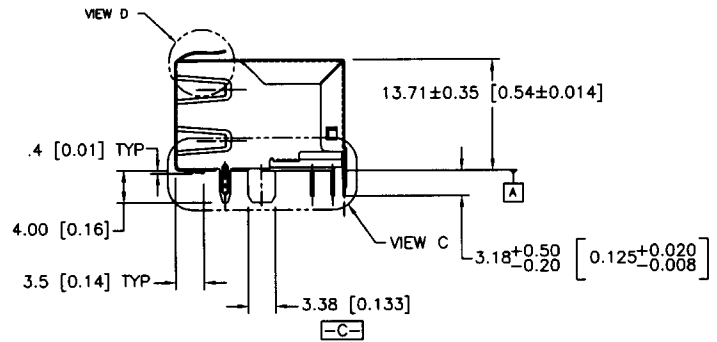
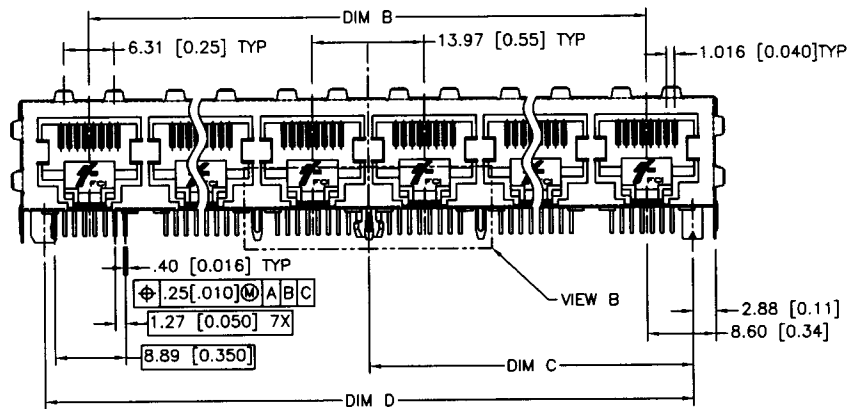
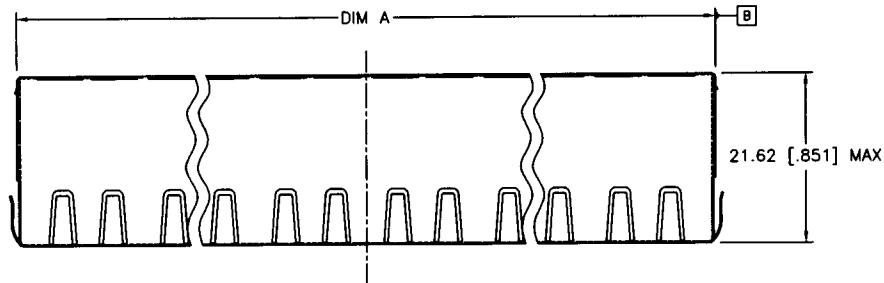

PRELIMINARY

mat'l. code				tolerances unless otherwise specified		CUSTOMER COPY	Electronics www.fciconnect.com
ltr	ecn no	dr	date	linear	.XX ±.01/.3		
A	V91919	BKB	9/13/99		.XXX ±.005/0.13		NETJACK II, RJ45 THRU HOLE DIAMOND PEG ASSEMBLY
B	V92061	LP	10/20/99	angles	.XXXX ±.0020/0.051		INCH/MM
				dr	B.BAHN 8/3/99	scale	size dwg no
				enr	B. BRUBAKER 8/3/99	1:1	A 98519
				chr	B. BRUBAKER 8/3/99		code
				appd	B. BRUBAKER 8/3/99		sheet 1 of 5
sheet index	revision sheet	B 1	B 2	B 3	B 4	B 5	cage code 22526

ACAD

Tous droits strictement réservés. Reproduction ou communication à des tiers interdite sous quelque forme que ce soit sans autorisation écrite du propriétaire. Propriété de c FCI. Droits de reproduction FCI.

All rights strictly reserved. Reproduction or issue to third parties in any form whatever is not permitted without written authority from the proprietor. Property of FCI. Copyright FCI.



PRODUCT NO
SEE TABLE

13.97 [0.550]

13.97 [0.550]

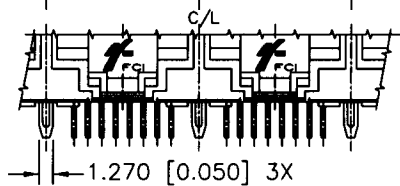

Φ .30 [.012] (M) A B C

FOR PORT NO. 4,6,8

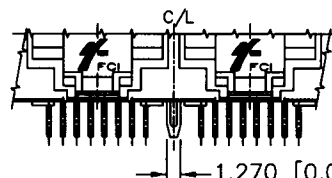

Φ .30 [.012] (M) A B C

FOR 2-PORT

VIEW B

(CENTER PEG OMITTED FOR CLARITY)

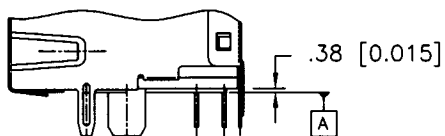

Φ .30 [.012] (M) A B C

3.68 [0.145]

6.35 [0.250]

8.89 [0.350]

10.32 [0.406]

VIEW C

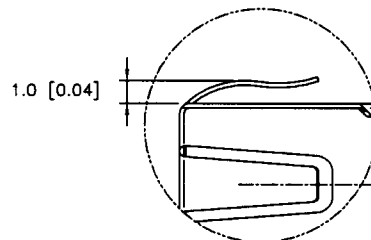

VIEW D

SCALE: 2/1

TYP FOR ALL GROUND SPRINGS

PRELIMINARY

mat'l. code				tolerances unless otherwise specified		CUSTOMER COPY		Electronics www.fciconnect.com			
ltr	ecn no	dr	date	linear	.XX ±.01/.3	projection		title			
B					.XXX ±.005/0.13			NETJACK II, RJ45 THRU HOLE		code	
					.XXX ±.0020/0.051			DIAMOND PEG ASSEMBLY			
				angles	0° ±2°	INCH/MM	scale	product family			
				dr	B.BAHN 8/3/99			MOD JACK		code	
				enr	B. BRUBAKER 8/3/99			size		dwg no	
				chr	B. BRUBAKER 8/3/99			A		98519	sheet
				appd	B. BRUBAKER 8/3/99	1:1		2 of			
sheet index	revision sheet							cage code			
								22526			

ACAD

cage code
22526

Tous droits strictement réservés. Reproduction ou communication à des tiers interdite sous quelque forme que ce soit sans autorisation écrite du propriétaire. Propriété de c FCI. Droits de reproduction FCI.

All rights strictly reserved. Reproduction or issue to third parties in any form whatever is not permitted without written authority from the proprietor. Property of FCI. Copyright FCI.

PRODUCT NO.	NO. OF PORTS	DIM A $\begin{matrix} +.60[.024] \\ -00[000] \end{matrix}$	DIM B	DIM C $\begin{matrix} \pm.10 \\ [\pm.004] \end{matrix}$	DIM D $\begin{matrix} \pm.15 \\ [\pm.006] \end{matrix}$	DIM E $\begin{matrix} \pm.13 \\ [\pm.005] \end{matrix}$
98519-52YXXX	2	31.68 [1.247]	13.97 [0.550]	12.70 [0.500]	25.40 [1.000]	32.11 [1.264]
98519-54YXXX	4	59.62 [2.347]	41.91 [1.650]	26.67 [1.050]	53.34 [2.100]	60.05 [2.364]
98519-56YXXX	6	87.56 [3.447]	69.85 [2.750]	40.64 [1.600]	81.28 [3.200]	87.99 [3.464]
98519-58YXXX	8	115.50 [4.547]	97.79 [3.850]	54.61 [2.150]	109.22 [4.300]	115.93 [4.564]

NETJACK MAGNETICS
OPTIONS CODE-XXX
SEE GES-12-020

SPRING OPTION Y	DESCRIPTION (SEE SHEET 5 FOR OPTIONAL VIEWS)
1	SPRING ON TOP,BOTTOM AND BOTH SIDES
2	NO SPRINGS
3	SPRINGS ON TOP AND BOTTOM
4	SPRINGS ON TOP,BOTTOM AND 1 PER SIDE (STAGGERED)
5	SAME AS OPTION 4 EXCEPT OPPOSITE STAGGER

NOTES:

- HOUSING MATL: HIGH TEMP. THERMOPLASTIC, COLOR BLACK, UL94V-0.
- CONTACT MATL: COPPER ALLOY
MATING AREA PLATING: Au OVER Ni., (SEE TABLE).
SOLDER AREA PLATING: 2.54uM/100u" MIN TIN LEAD OVER Ni.
- SHIELDING MAT'L: TIN PLATED COPPER ALLOY.
- ALL DIMENSIONS IN MILLIMETERS AND INCHES.
- SEE SHEET 5 FOR GROUND TAB CONFIGURATION.
- CENTER PEG FOR 8 PORT ONLY.

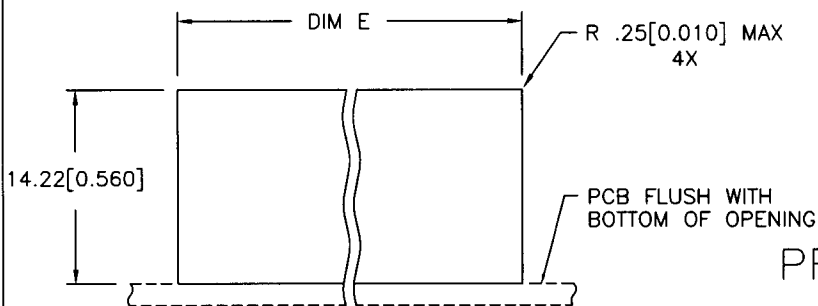

RECOMMENDED PANEL OPENING

PRELIMINARY

mat'l. code				tolerances unless otherwise specified		CUSTOMER COPY		Electronics FCI www.fciconnect.com		
ltr	ecn no	dr	date	linear	.XX ±.01/.3	projection	INCH/MM	title		
B					.XXX ±.005/0.13			NETJACK II, RJ45 THRU HOLE		code
				angles	.XXXX ±.0020/0.051			DIAMOND PEG ASSEMBLY		
				dr	B.BAHN 8/3/99	scale	1:1	product family	MOD JACK	
				enrg	B. BRUBAKER 8/3/99	A	98519	size	dwg no	
				chr	B. BRUBAKER 8/3/99				sheet	
				appd	B. BRUBAKER 8/3/99				3 of	
sheet index	revision sheet									

cage code
22526

Tous droits strictement reserves. Reproduction ou communication a des tiers interdite sous quelque forme que ce soit sans autorisation écrite du propriétaire. Propriete de c FCI. Droits de reproduction FCI.

All rights strictly reserved. Reproduction or issue to third parties in any form whatever is not permitted without written authority from the proprietor. Property of FCI. Copyright FCI.

PRODUCT NO
SEE TABLE

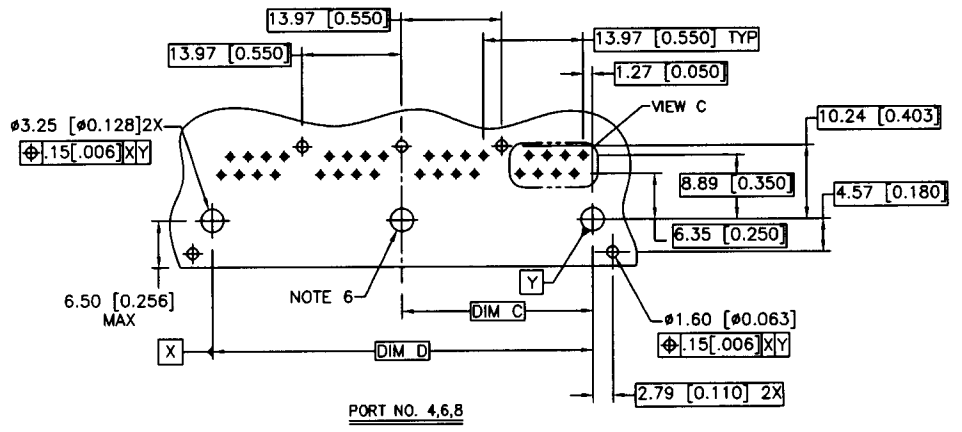
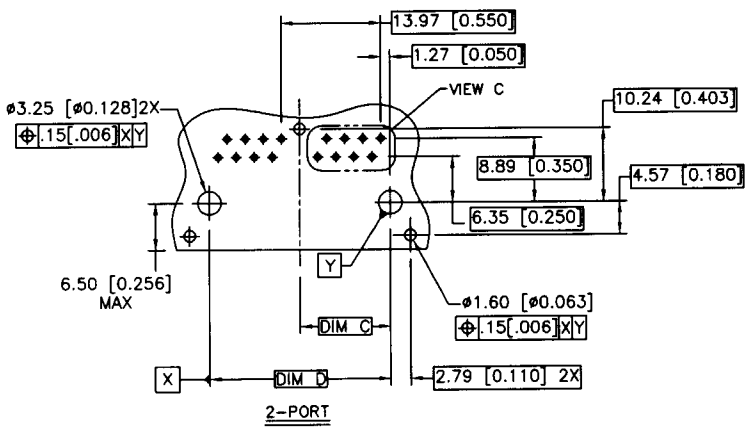

RECOMMENDED P.C.B LAYOUT
AS VIEWED FROM TOP SIDE (COMPONENT SIDE)

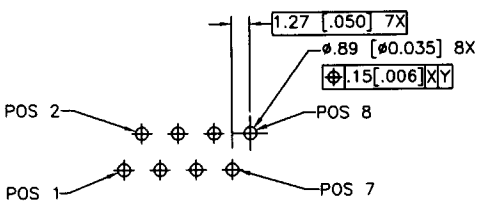

VIEW C
SCALE 2/1
TYPICAL FOOTPRINT

PRELIMINARY

mat'l. code				tolerances unless otherwise specified		CUSTOMER COPY		Electronics www.fciconnect.com			
ltr	ecn no	dr	date	linear	.XX ±.01/.3	projection		title			
B					.XXX ±.005/0.13			NETJACK II, RJ45 THRU HOLE		code	
					.XXXX ±.0020/0.05			DIAMOND PEG ASSEMBLY		-	
				angles	0° ±2°	INCH/MM		product family MOD JACK			
				dr	B.BAHN 8/3/99			size dwg no		sheet	
				engr	B. BRUBAKER 8/3/99			A 98519		4 of	
				chr	B. BRUBAKER 8/3/99			scale 1:1			
				appd	B. BRUBAKER 8/3/99						
sheet index		revision sheet						cage code 22526			

1 | 2

3 |

4

PRODUCT NO
SEE TABLE

SPRING TAB CONFIGURATION OPTION Y

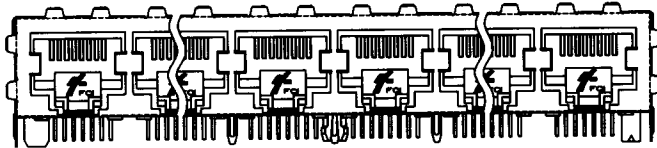

SPRING OPTION 1

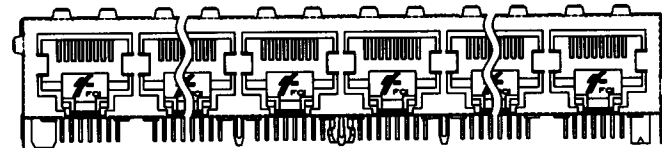

SPRING OPTION 4

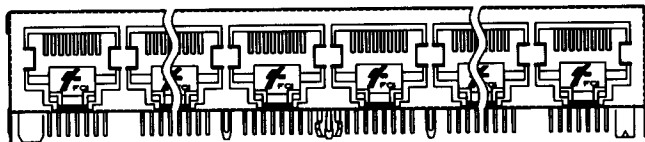

SPRING OPTION 2

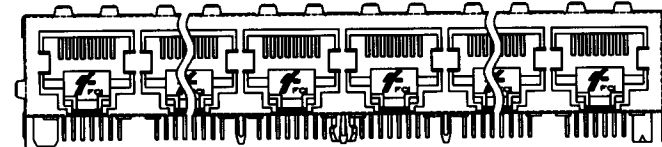

SPRING OPTION 5

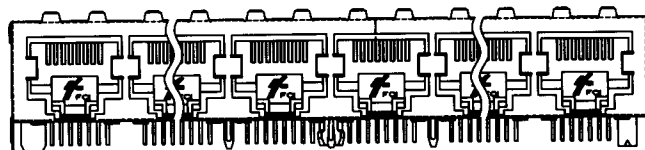

SPRING OPTION 3

PRELIMINARY

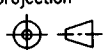
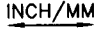
mat'l. code				tolerances unless otherwise specified		CUSTOMER COPY		 Electronics <small>www.fciconnect.com</small>						
ltr	ecn no	dr	date	linear	.XX ±.01/.3	projection		title						
B					.XXX ±.005/0.13			NETJACK II, RJ45 THRU HOLE		code				
				angles	.XXX ±.0020/0.05	INCH/MM		DIAMOND PEG ASSEMBLY						
				dr	0° ±2°			product family	MOD JACK	sheet				
				enqr	B. BAHN 8/3/99	scale	1:1	A	98519	5 of				
				chr	B. BRUBAKER 8/3/99						size	dwg no	-	
				appd	B. BRUBAKER 8/3/99									
sheet index	revision sheet													

cage code
22526

1 | 2

3 |

4

ACAD

Tous droits strictement réservés. Reproduction ou communication à des tiers interdite sous quelque forme que ce soit sans autorisation écrite du propriétaire. Propriété de c FCI. Droits de reproduction FCI.



All rights strictly reserved. Reproduction or issue to third parties in any form whatever is not permitted without written authority from the proprietor. Property of FCI. Copyright FCI.