



Description

The GM76FV8256/ GM76FU8256/ GM76FS8256/ GM76FR8256 is a 2,097,152 bits static random access memory organized as 262,144 words by 8 bits. It uses an advanced Full CMOS process technology and high speed and low power circuit technology. Thus it is suitable for high speed and low power applications, especially where battery back-up is required.

Features

- Power Supply Voltage
 GM76FV8256 Family : 3.0 ~ 3.6V
 GM76FU8256 Family : 2.7 ~ 3.3V
 GM76FS8256 Family : 2.2 ~ 2.7V
 GM76FR8256 Family : 1.8 ~ 2.2V
- Completely Static RAM : No Clock or Timing Strobe Required
- TTL compatible inputs and outputs
- Capability of Battery Back-up Operation
- Package : 32-TSOP-I, 32-sTSOP-I

Product Family

Product Family	Operating Temp. Range	Voltage Range	Speed	Standby Current Iccs2(LL/SL)	Operating Current(Icc1)
GM76FV8256LL/SL GM76FU8256LL/SL GM76FS8256LL/SL GM76FR8256LL/SL	Commercial (0 ~ 70 °C)	3.0 ~ 3.6V 2.7 ~ 3.3V 2.2 ~ 2.7V 1.8 ~ 2.2V	*55/70/85ns *55/70/85ns *85/100ns *100/120ns	10/2 uA	70mA 65mA 40mA 30mA
GM76FV8256LLI/SLI GM76FU8256LLI/SLI GM76FS8256LLI/SLI GM76FR8256LLI/SLI	Industrial (-40 ~ 85 °C)	3.0 ~ 3.6V 2.7 ~ 3.3V 2.2 ~ 2.7V 1.8 ~ 2.2V	*55/70/85ns *55/70/85ns *85/100ns *100/120ns	10/2 uA	70mA 65mA 40mA 30mA

* The parameter is measured with 30pF test load.

Pin Configuration

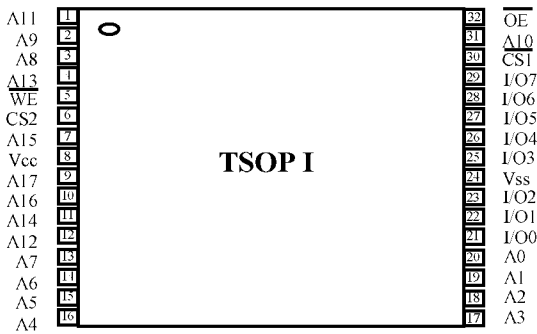

Block Diagram

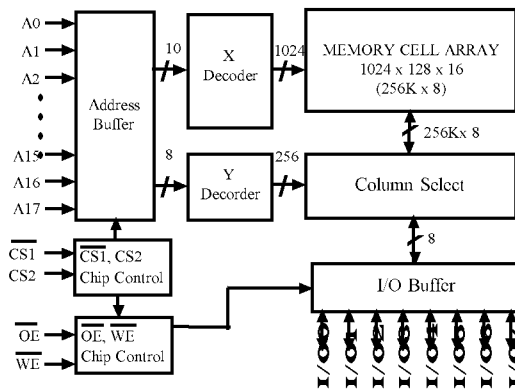

Pin Description

Pin	Function	Pin	Function
A0-A17	Address Inputs	I/O0-I/O7	Data Inputs/Outputs
\overline{WE}	Write Enable Input	Vcc	Power Supply
$\overline{CS1}, \overline{CS2}$	Chip Select Input	Vss	Ground
\overline{OE}	Output Enable Input		

Absolute Maximum Ratings*

Symbol	Parameter		Rating	Unit
T _A	Ambient Temperature under Bias	GM76FV8256 GM76FU8256 GM76FS8256 GM76FR8256	0 ~ 70	°C
		GM76FV8256-I GM76FU8256-I GM76FS8256-I GM76FR8256-I	-40 ~ 85	
T _{STG}	Storage Temperature		-55 ~ 150	°C
T _{SOL}	Soldering Temperature and Time		260, 10 (at lead)	°C, S
V _{CC}	Supply Voltage		-0.2 ~ 4.0**	V
V _{IN}	Input Voltage		-0.2 ~ V _{CC} + 0.5	V
V _{I/O}	Input and Output Voltage		-0.2 ~ V _{CC} + 0.5	V
P _D	Power Dissipation		1	W

*: Stresses greater than those listed under "Absolute Maximum Ratings" may cause permanent damage to the device. This is a stress rating only and functional operation of the device at these or any other conditions above those indicated in the operating sections of this specification is not implied. Exposure to absolute maximum rating conditions for extended periods may affect reliability.

** : Maximum V_{CC} = -0.2 to 4.6V for GM76FV8256 Family and GM76FU8256 Family

Recommended DC Operating Conditions*

Symbol	Parameter	Product	Min	Typ	Max	Unit
V _{CC}	Supply Voltage	GM76FV8256 Family	3.0	3.3	3.6	V
		GM76FU8256 Family	2.7	3.0	3.3	
		GM76FS8256 Family	2.2	2.5	2.7	
		GM76FR8256 Family	1.8	2.0	2.2	
V _{IH}	Input High Voltage	GM76FV8256 Family	2.2	-	V _{CC} + 0.2	V
		GM76FU8256 Family	2.2			
		GM76FS8256 Family	2.0			
		GM76FR8256 Family	1.6			
V _{IL}	Input Low Voltage	All Product	-0.2**	-	0.4	V

* 1) Commercial Product : T_a = 0 ~ 70 °C, unless otherwise specified
 2) Industrial Product : T_a = -40 ~ 85 °C, unless otherwise specified

** V_{IL}(min) = -1.5V for ≤ 30ns pulse

Truth Table

$\overline{CS1}$	CS2	\overline{OE}	\overline{WE}	A0 to A17	DATA I/O	MODE
L	H	L	H	Stable	Output Data	Read
L	H	X	L	Stable	Input Data	Write
L	H	H	H	Stable	Hi-Z	Output Disable
H	X	X	X	-	Hi-Z	Standby
X	L	X	X	-	Hi-Z	

*Note: X means don't care

Capacitance (f = 1MHz, T_A = 25°C)

Symbol	Parameter	Test Conditions	Min	Max	Unit
C _{IN}	Input Capacitance	V _I = 0V	-	8	pF
C _{IO}	Output Capacitance	V _O = 0V	-	10	pF

*Note: This parameter is sampled and not 100% tested.

DC Operating Characteristics

Symbol	Parameter	Conditions	Min	Typ	Max	Unit	
$I_{i(L)}$	Input Leakage Current	$V_{IN} = 0$ to V_{CC}	-1	-	1	μA	
$I_{o(L)}$	Output Leakage Current	$\overline{CS1} = V_{IH}$ or $CS2 = V_{IL}$ $\overline{OE} = V_{IH}, V_{SS} \leq V_{OUT} \leq V_{CC}$	-1	-	1	μA	
V_{OH}	High Level Output Voltage	$I_{OH} = -1.0mA$ at $V_{CC}=3.0/3.3V$ $I_{OH} = -0.5mA$ at $V_{CC}=2.5V$ $I_{OH} = -0.44mA$ at $V_{CC}=2.0V$	2.2 2.0 1.6	-	-	V	
V_{OL}	Low Level Output Voltage	$I_{OL} = 2.1mA$ at $V_{CC}=3.0/3.3V$ $I_{OL} = 0.5mA$ at $V_{CC}=2.5V$ $I_{OL} = 0.33mA$ at $V_{CC}=2.0V$	-	-	0.4	V	
I_{CC}	Operating Supply Current	$\overline{CS1} = V_{IL}$ and $CS2 = V_{IH}$, $V_{IN} = V_{IH}/V_{IL}, I_{OUT} = 0mA$	-	-	10	mA	
I_{CC1}	Average Operating Current	$\overline{CS1} = V_{IL}$ and $CS2 = V_{IH}$ $V_{IN} = V_{IH}/V_{IL}, I_{OUT} = 0mA$ tcycle = Min, cycle	$V_{CC}=3.3V@55ns$	-	-	70	mA
			$V_{CC}=3.0V@55ns$	-	-	65	
			$V_{CC}=2.5V@85ns$	-	-	40	
			$V_{CC}=2.0V@100ns$	-	-	30	
I_{CC2}		$\overline{CS1} = 0.2V, CS2 = V_{CC}-0.2V$ $V_{IN} = V_{CC} - 0.2V/0.2V$ $I_{OUT} = 0mA, t_{cycle} = 1\mu s$	-	-	10	mA	
I_{CCS1}	Standby Current(TTL)	$\overline{CS1} = V_{IH}, CS2 = V_{IL}$	-	-	0.3	mA	
I_{CCS2}	Standby Current(CMOS)	$\overline{CS1} = V_{CC}-0.2V, CS2 = 0.2V$	SL	-	-	2	μA
			LL	-	-	10	

AC Operating Characteristics

Test Conditions

Parameter	Value			
	V_{CC}	3.0,3.3V	2.5V	2.0V
Input Pulse Level		0.4 to 2.2V		0.4 to 1.8V
Input Rise and Fall Time		5ns		
Input and Output Timing Reference Levels		1.5V	1.1V	0.9V
Output Load		$C_L = 30pF(100 pF)$ + 1 TTL Load		

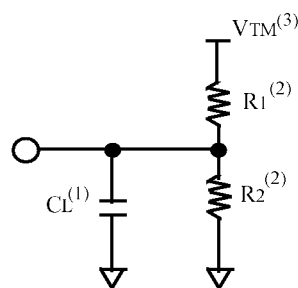

- (1) Including Scope and Jig Capacitance
- (2) $R_1 = 3070\Omega, R_2 = 3150\Omega$
- (3) $V_{TM} = 2.8V$ for $V_{CC} = 3.0/3.3V$
 $= 2.3V$ for $V_{CC} = 2.5V$
 $= 1.8V$ for $V_{CC} = 2.0V$

PRELIMINARY**GM76FV8256, GM76FU8256, GM76FS8256, GM76FR8256****AC Operating Characteristics****Read Cycle**

(Commercial Product : Ta = 0 ~ 70°C, Industrial Product : Ta = -40 ~ 85°C)

Symbol	Parameter	55ns		70ns		85ns		Unit
		Min	Max	Min	Max	Min	Max	
t _{RC}	Read Cycle Time	55	-	70	-	85	-	ns
t _{AA}	Address Access Time	-	55	-	70	-	85	ns
t _{ACS1}	Chip Select 1 Access Time	-	55	-	70	-	85	ns
t _{ACS2}	Chip Select 2 Access Time	-	55	-	70	-	85	ns
t _{OE}	Output Enable Access Time	-	30	-	35	-	45	ns
t _{CLZ1}	Chip Select 1 Output Setup Time	5	-	5	-	10	-	ns
t _{ClZ1}	Chip Select 1 Output Floating	0	20	0	25	0	30	ns
t _{CLZ2}	Chip Select 2 Output Setup Time	5	-	5	-	10	-	ns
t _{ClZ2}	Chip Select 2 Output Floating	0	20	0	25	0	30	ns
t _{OLZ}	Output Enable Output Setup Time	5	-	5	-	5	-	ns
t _{OlZ}	Output Enable Output Floating	0	20	0	25	0	30	ns
t _{OH}	Output Hold Time	5	-	10	-	10	-	ns

Write Cycle

Symbol	Parameter	55ns		70ns		85ns		Unit
		Min	Max	Min	Max	Min	Max	
t _{wc}	Write Cycle Time	55	-	70	-	85	-	ns
t _{cw1}	Chip Select Time 1	50	-	65	-	75	-	ns
t _{cw2}	Chip Select Time 2	50	-	65	-	75	-	ns
t _{AW}	Address Enable Time	50	-	60	-	70	-	ns
t _{AS}	Address Setup Time	0	-	0	-	0	-	ns
t _{WP}	Write Pulse Width	45	-	50	-	60	-	ns
t _{WR}	Write Recovery Time	0	-	0	-	0	-	ns
t _{DW}	Input Data Setup Time	25	-	30	-	35	-	ns
t _{DH}	Input Data Hold Time	0	-	0	-	0	-	ns
t _{wHZ}	Write to Output in High-Z	0	20	0	25	0	30	ns
t _{OW}	Output Active from End of Write	5	-	5	-	5	-	ns

PRELIMINARY**GM76FV8256, GM76FU8256, GM76FS8256, GM76FR8256****AC Operating Characteristics****Read Cycle**

(Commercial Product : Ta = 0 ~ 70°C, Industrial Product : Ta = -40 ~ 85°C)

Symbol	Parameter	100ns		120ns		Unit
		Min	Max	Min	Max	
t _{RC}	Read Cycle Time	100	-	120	-	ns
t _{AA}	Address Access Time	-	100	-	120	ns
t _{ACS1}	Chip Select 1 Access Time	-	100	-	120	ns
t _{ACS2}	Chip Select 2 Access Time	-	100	-	120	ns
t _{OE}	Output Enable Access Time	-	50	-	60	ns
t _{CLZ1}	Chip Select 1 Output Setup Time	10	-	20	-	ns
t _{CI1Z1}	Chip Select 1 Output Floating	0	35	0	35	ns
t _{CLZ2}	Chip Select 2 Output Setup Time	10	-	10	-	ns
t _{CI2Z2}	Chip Select 2 Output Floating	0	35	0	35	ns
t _{OLZ}	Output Enable Output Setup Time	5	-	5	-	ns
t _{O1Z}	Output Enable Output Floating	0	35	0	35	ns
t _{OH}	Output Hold Time	10	-	15	-	ns

Write Cycle

Symbol	Parameter	100ns		120ns		Unit
		Min	Max	Min	Max	
t _{wc}	Write Cycle Time	100	-	120	-	ns
t _{cw1}	Chip Select Time 1	85	-	100	-	ns
t _{cw2}	Chip Select Time 2	85	-	100	-	ns
t _{AW}	Address Enable Time	80	-	90	-	ns
t _{AS}	Address Setup Time	0	-	0	-	ns
t _{WP}	Write Pulse Width	70	-	80	-	ns
t _{WR}	Write Recovery Time	0	-	0	-	ns
t _{DW}	Input Data Setup Time	40	-	50	-	ns
t _{DH}	Input Data Hold Time	0	-	0	-	ns
t _{w1Z}	Write to Output in High-Z	0	40	0	40	ns
t _{OW}	Output Active from End of Write	10	-	10	-	ns

Timing Waveforms

Read Cycle (Note 1)

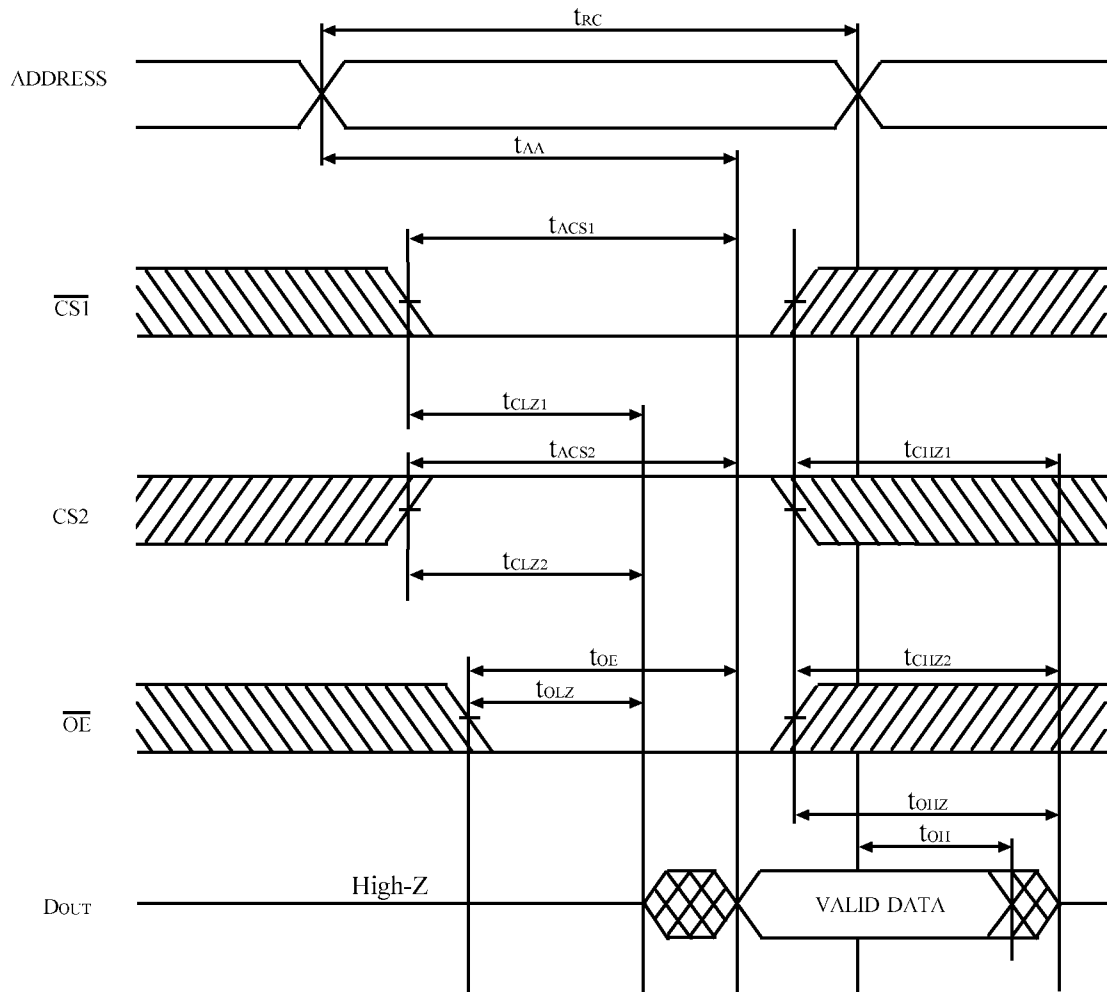

Write Cycle (1) ($\overline{\text{WE}}$ Controlled) (Notes 2, 3, 4)

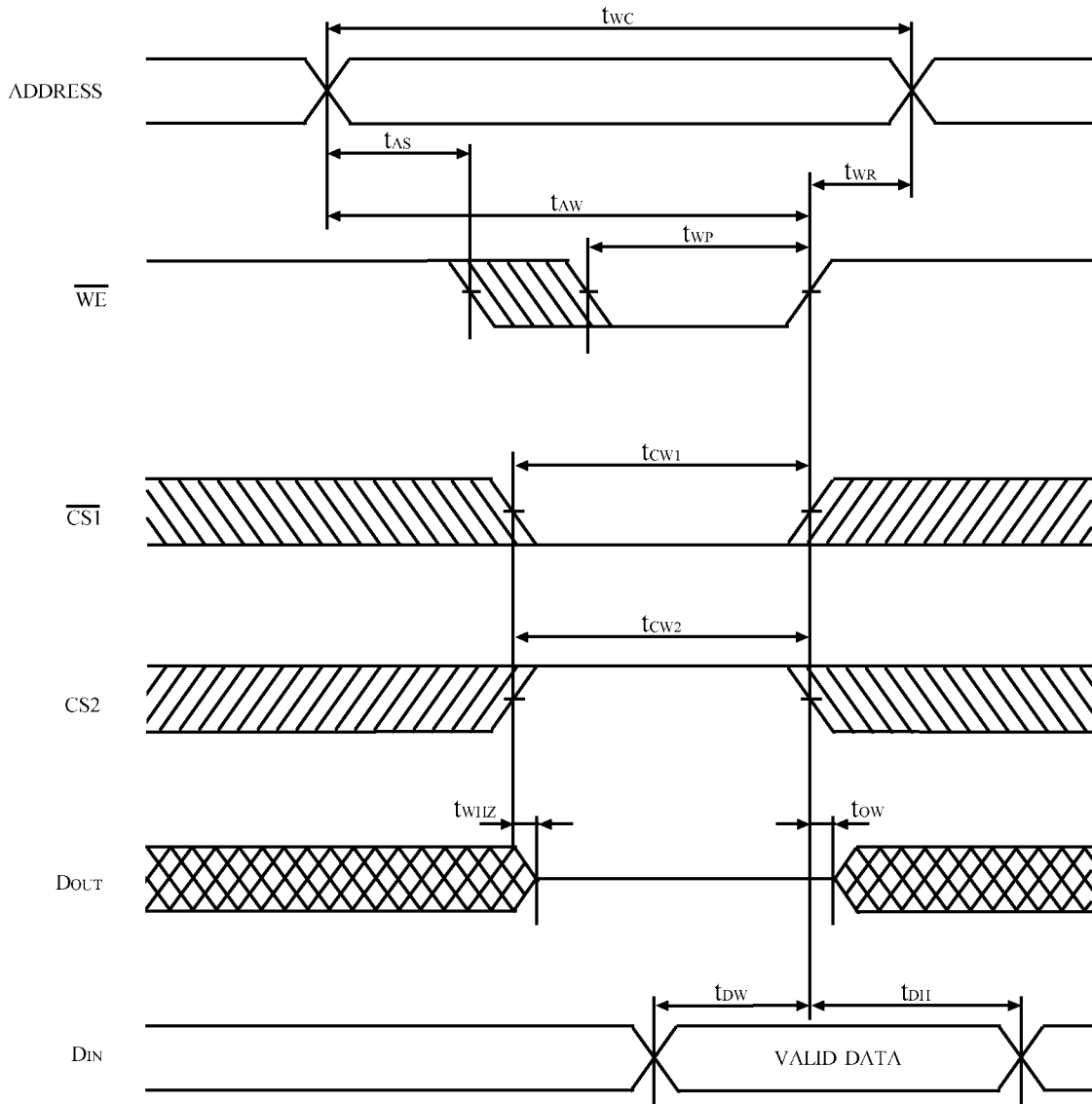

Write Cycle (2) ($\overline{CS1}$ Controlled) (Notes 4)

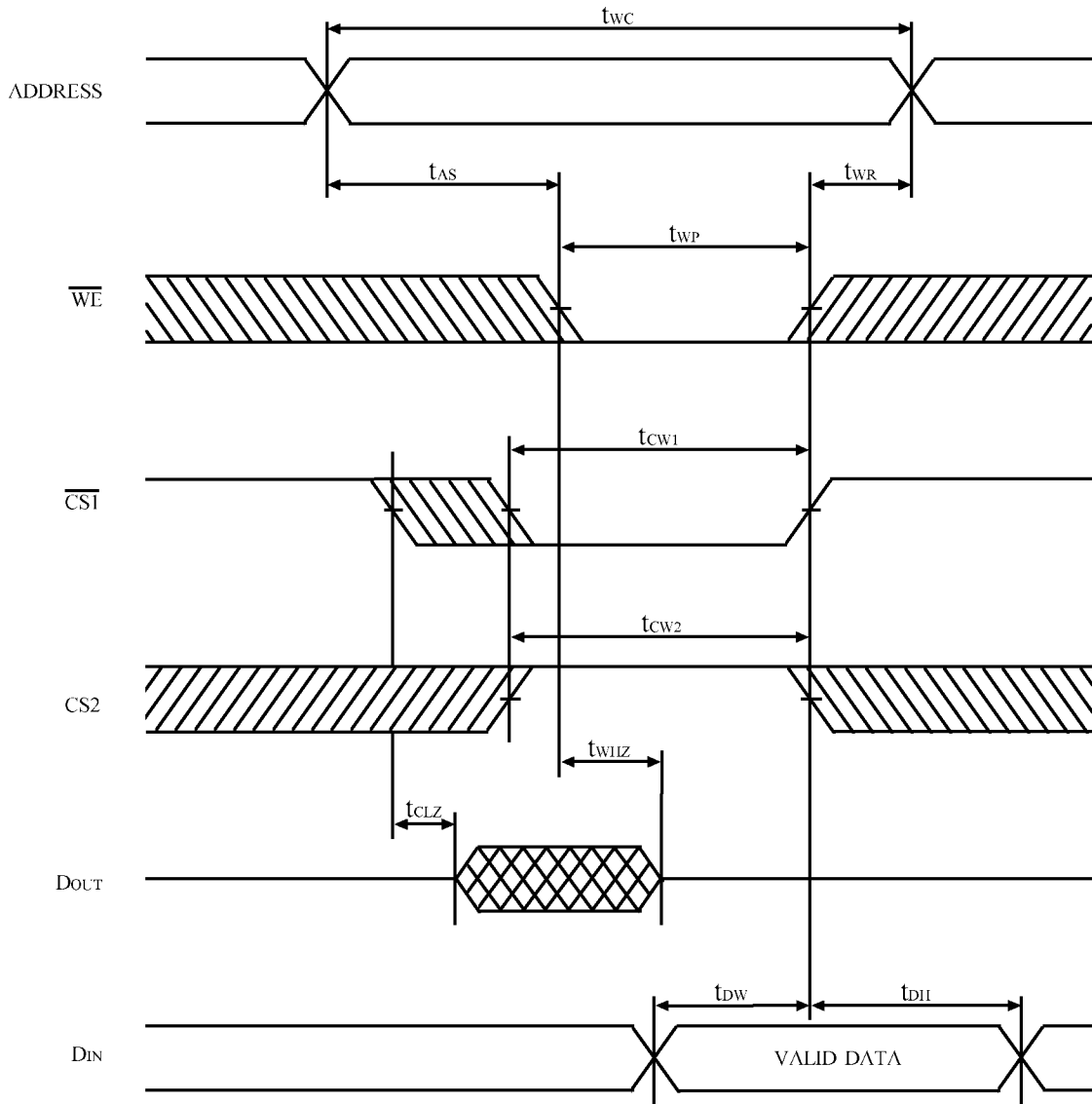

Write Cycle (3) (CS2 Controlled) (Notes 4)

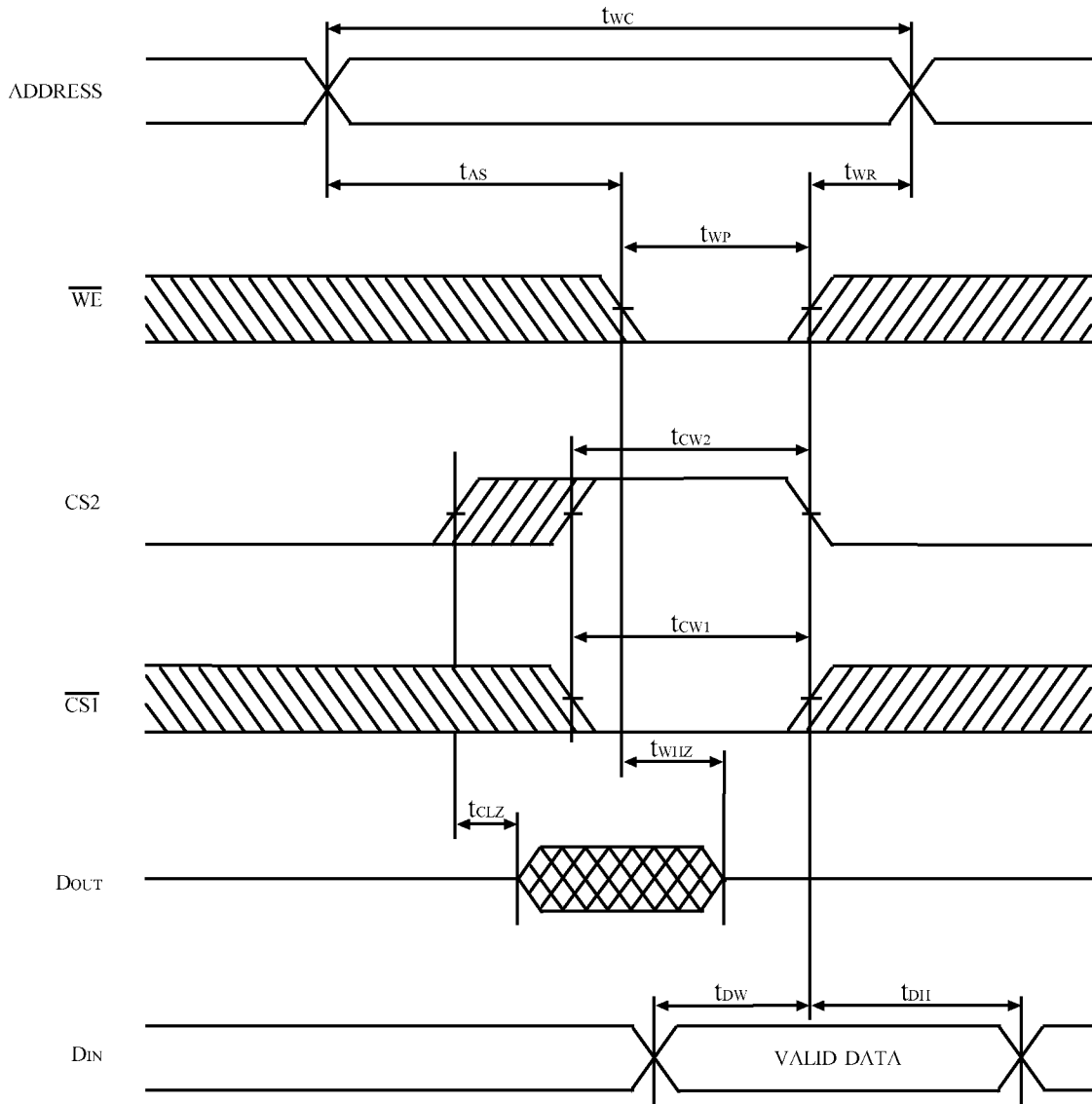

Notes:

1. \overline{WE} is High for Read Cycle.
2. Assuming that $\overline{CS1}$ Low transition or CS2 High transition occurs coincident with or after \overline{WE} Low transition. Outputs remain in a high impedance state.
3. Assuming that $\overline{CS1}$ High transition or CS2 Low transition occurs coincident with or prior to \overline{WE} High transition. Outputs remain in a high impedance state.
4. Assuming that \overline{OE} is high for write cycle. Outputs are in a high impedance state during this period.

Data Retention Characteristics

Symbol	Parameter		Min	Typ	Max	Unit
V _{CCR}	Data Retention Supply Voltage		1.5	-	3.6	V
I _{CCR}	Data Retention Current	V _{CC} =3.0V	-	0.5	2	μA
			-	0.5	10	
t _{CDR}	Chip Select to Data Retention Time		0			ns
t _R	Operation Recovery Time		t _{RC(2)}			ns

(1) Test Condition

- Commercial Product : Ta = 0 ~ 70 °C
- Industrial Product : Ta = -40 ~ 85 °C

(2) t_{RC} = Read cycle time

• Low V_{CC} Data Retention Mode: (1) $\overline{\text{CS1}}$ Controlled

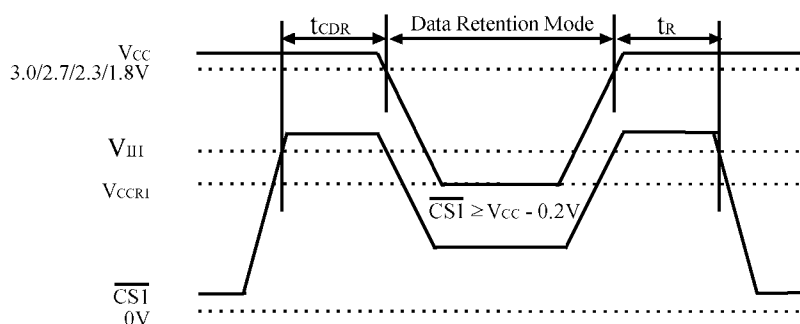

• Low V_{CC} Data Retention Mode: (2) CS2 Controlled

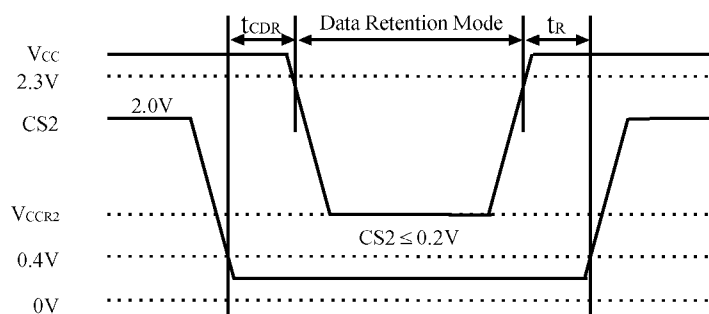

Notes: In Data Retention Mode, CS2 controls the Address, $\overline{\text{WE}}$, $\overline{\text{CS1}}$, $\overline{\text{OE}}$ and D_{IN} buffer. If CS2 controls data retention mode, V_{IN} for these inputs can be in the high impedance state. If CS1 controls the data retention mode, CS2 must satisfy either CS2 ≥ V_{CC} - 0.2V or CS2 ≤ 0.2V. The other input levels (Address, $\overline{\text{WE}}$, $\overline{\text{OE}}$, I/O) can be in the high impedance state.

Package Dimensions

Unit: Inches (mm)

32 TSOP I (8 x 20 mm)

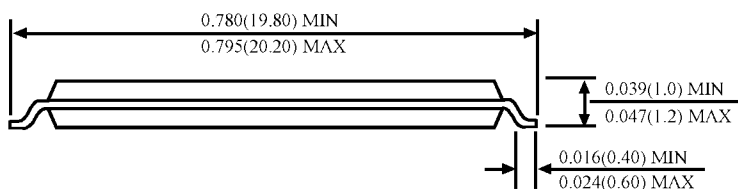
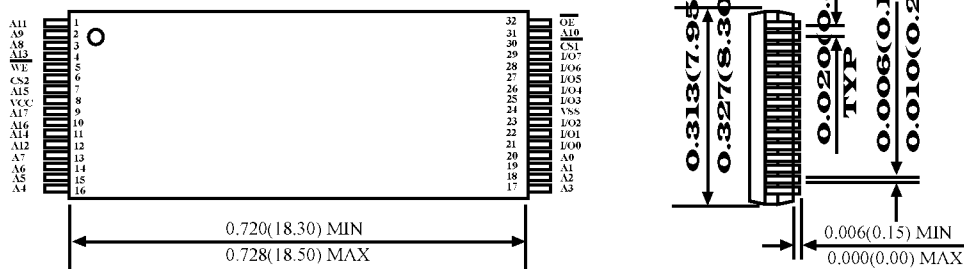

32 Small TSOP I (8 x 13.4 mm)

