

# Surface Mount Zener Diode

## CZRC5348 Thru CZRC5388

Voltage: 11 - 200 Volts  
Power: 5.0 Watts

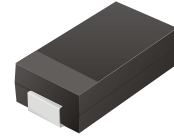

### Features

For surface mounted applications in order to optimize board space

Low profile package

Glass passivated junction

Low inductance

Built-in strain relief

High temperature soldering :260°C /10 seconds at terminals

### Mechanical data

Case: JEDEC DO -214AB Molded plastic over passivated junction

Terminals: Solder plated, solderable per, MIL-STD-750, method 2026

Standard Packaging: 16mm tape(EIA- 481)

Weight: 0.007 ounce, 0.21 gram

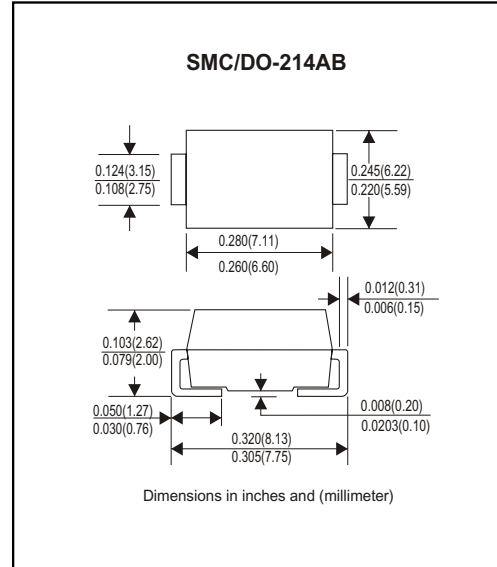

### Maximum Ratings and Electrical Characteristics

Ratings at 25°C ambient temperature unless otherwise specified.

	SYMBOL	VALUE	UNITS
DC Power Dissipation @ $T_L=75^\circ\text{C}$ , Measure at Zero Lead Length(Fig. 1)	$P_D$	5.0	Watts
Derate above 75°C (Note 1)		40.0	mW/°C
Peak forward Surge Current 8.3ms single half sine-wave superimposed on rated load(JEDEC Method) (Note 1,2)	$I_{FSM}$	See Fig. 5	Amps
Operating Junction and Storage Temperature Range	$T_J, T_{STG}$	-55 to +150	°C

#### NOTES:

1. Mounted on 8.0mm<sup>2</sup> copper pads to each terminal.
2. 8.3ms single half sine-wave, or equivalent square wave, duty cycle = 4 pulses per minute maximum.

# Surface Mount Zener Diode

Type No. (Note 1.)	Nominal Zener Voltage $V_Z @ I_{ZT}$ volts (Note 2.)	Test current $I_{ZT}$ mA	Maximum Zener Impedance		Max reverse Leakage Current			Max Surge Current $I_r$ Amps	Max Voltage Regulation $V_Z$ , Volts	Maximum Regulator Current $I_{ZM}$ mA
			$Z_{ZT} @ I_{ZT}$ Ohms (Note 2.)	$Z_{ZK} @ I_{ZK}$ = 1 mA Ohms (Note 2.)	$I_R$ uA	@ $V_R$ Volts				
						Non & A Suffix	B-Suffix			
CZRC5348	11	125	2.5	125	5	8	8.4	8	0.25	430
CZRC5349	12	100	2.5	125	2	8.6	9.1	7.5	0.25	395
CZRC5350	13	100	2.5	100	1	9.4	9.9	7	0.25	365
CZRC5351	14	100	2.5	75	1	10.1	10.6	6.7	0.25	340
CZRC5352	15	75	2.5	75	1	10.8	11.5	6.3	0.25	315
CZRC5353	16	75	2.5	75	1	11.5	12.2	6	0.3	295
CZRC5354	17	70	2.5	75	0.5	12.2	12.9	5.8	0.35	280
CZRC5355	18	65	2.5	75	0.5	13	13.7	5.5	0.4	265
CZRC5356	19	65	3	75	0.5	13.7	14.4	5.3	0.4	250
CZRC5357	20	65	3	75	0.5	14.4	15.2	5.1	0.4	237
CZRC5358	22	50	3.5	75	0.5	15.8	16.7	4.7	0.45	216
CZRC5359	24	50	3.5	100	0.5	17.3	18.2	4.4	0.55	198
CZRC5360	25	50	4	110	0.5	18	19	4.3	0.55	190
CZRC5361	27	50	5	120	0.5	19.4	20.6	4.1	0.6	176
CZRC5362	28	50	6	130	0.5	20.1	21.2	3.9	0.6	170
CZRC5363	30	40	8	140	0.5	21.6	22.8	3.7	0.6	158
CZRC5364	33	40	10	150	0.5	23.8	25.1	3.5	0.6	144
CZRC5365	36	30	11	160	0.5	25.9	27.4	3.3	0.65	132
CZRC5366	39	30	14	170	0.5	28.1	29.7	3.1	0.65	122
CZRC5367	43	30	20	190	0.5	31	32.7	2.8	0.7	110
CZRC5368	47	25	25	210	0.5	33.8	35.8	2.7	0.8	100
CZRC5369	51	25	27	230	0.5	36.7	38.8	2.5	0.9	93
CZRC5370	56	20	35	280	0.5	40.3	42.6	2.3	1	86
CZRC5371	60	20	40	350	0.5	43	45.5	2.2	1.2	79
CZRC5372	62	20	42	400	0.5	44.6	47.1	2.1	1.35	76
CZRC5373	68	20	44	500	0.5	49	51.7	2	1.5	70
CZRC5374	75	20	45	620	0.5	54	56	1.9	1.6	63
CZRC5375	82	15	65	720	0.5	59	62.2	1.8	1.8	58
CZRC5376	87	15	75	760	0.5	63	66	1.7	2	54.5
CZRC5377	91	15	75	760	0.5	65.5	69.2	1.6	2.2	52.5
CZRC5378	100	12	90	800	0.5	72	76	1.5	2.5	47.5
CZRC5379	110	12	125	1000	0.5	79.2	83.6	1.4	2.5	43
CZRC5380	120	10	170	1150	0.5	86.4	91.2	1.3	2.5	39.5
CZRC5381	130	10	190	1250	0.5	93.6	98.8	1.2	2.5	36.6
CZRC5382	140	8	230	1500	0.5	101	106	1.2	2.5	34
CZRC5383	150	8	330	1500	0.5	108	114	1.1	3	31.6
CZRC5384	160	8	350	1650	0.5	115	122	1.1	3	29.4
CZRC5385	170	8	380	1750	0.5	122	129	1	3	28
CZRC5386	180	5	430	1750	0.5	130	137	1	4	26.4
CZRC5387	190	5	450	1850	0.5	137	144	0.9	5	25
CZRC5388	200	5	480	1850	0.5	144	152	0.9	5	23.6

**NOTE:**

1. TOLERANCE AND VOLTAGE DESIGNATION - The JEDEC type numbers shown indicate a tolerance of +/- 10% with guaranteed limits on only  $V_Z$ ,  $I_R$ ,  $I_r$ , and  $V_F$  as shown in the electrical characteristics table. Units with guaranteed limits on all seven parameters are indicated by suffix "B" for +5% tolerance.
2. ZENER VOLTAGE ( $V_Z$ ) AND IMPEDANCE ( $Z_{ZT}$  &  $Z_{ZK}$ ) - Test conditions for Zener voltage and impedance are as follows;  $I_Z$  is applied 40 10 ms prior to reading. Mounting contacts are located from the inside edge of mounting clips to the body of the diode.

## Rating and Characteristic Curves (CZRC5348 Thru CZRC5388)

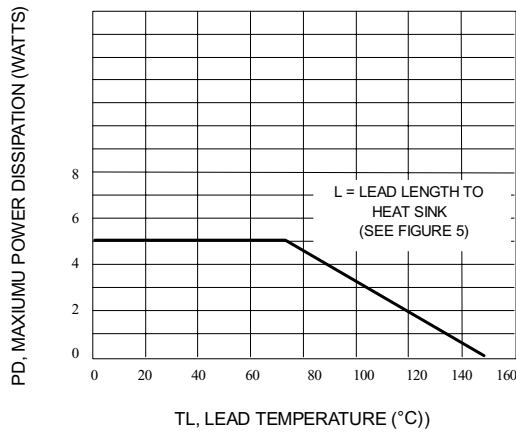

Fig. 1-POWER TEMPERATURE DERATING CURVE

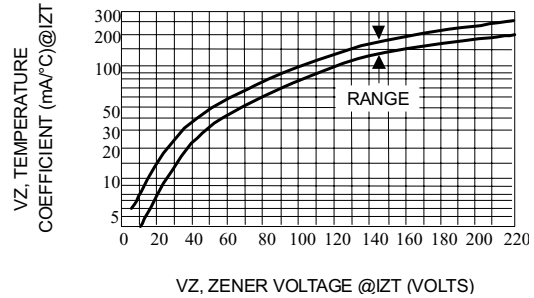

Fig. 2-TEMPERATURE COEFFICIENT-RANGE FOR UNITS 6 TO 220 VOLTS

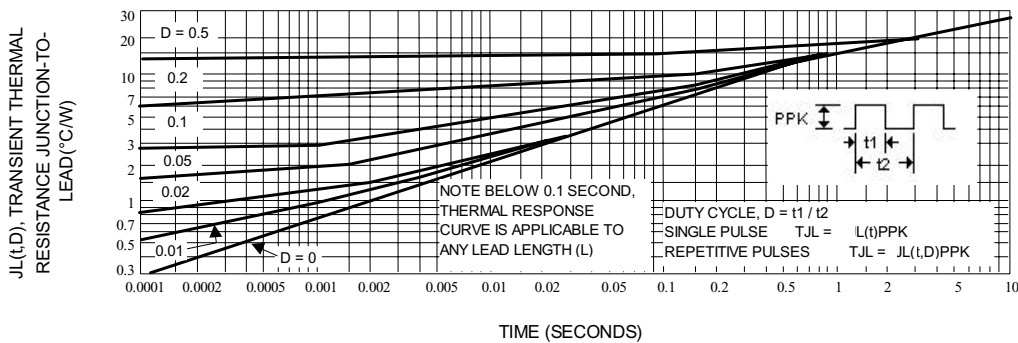

Fig. 3-TYPICAL THERMAL RESPONSE

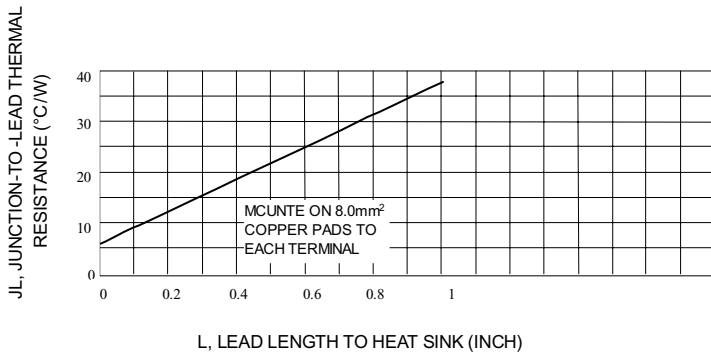

Fig. 4-TYPICAL THERMAL RESISTANCE

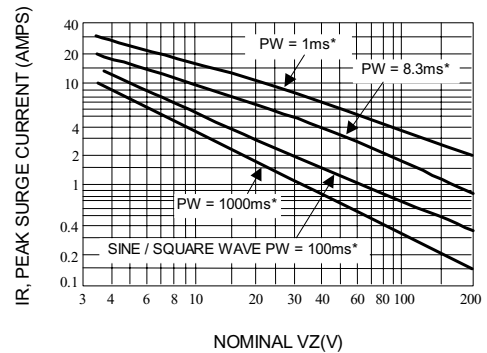

Fig. 5-MAXIMUM NON-REPETITIVE SURGE CURRENT VERSUS NOMINAL ZENER VOLTAGE (SEE NOTE 3)

## Rating and Characteristic Curves (CZRC5348 Thru CZRC5388)

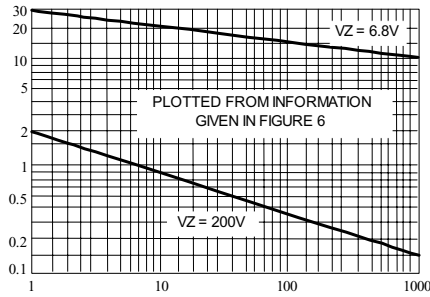

Fig. 6-PEAK SURGE CURRENT VERSUS PULSE WIDTH(SEE NOTE 3)

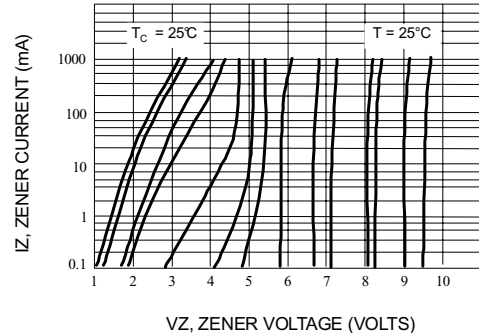

Fig. 7-ZENER VOLTAGE VERSUS ZENER CURRENT VZ = 6.8 THRU 10 VOLTS

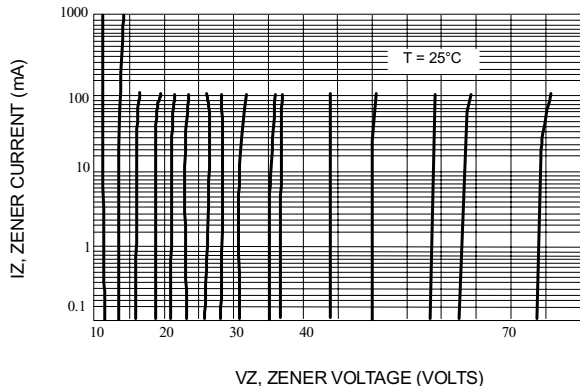

Fig. 8-ZENER VOLTAGE VERSUS ZENER CURRENT VZ = 11 THRU 75 VOLTS

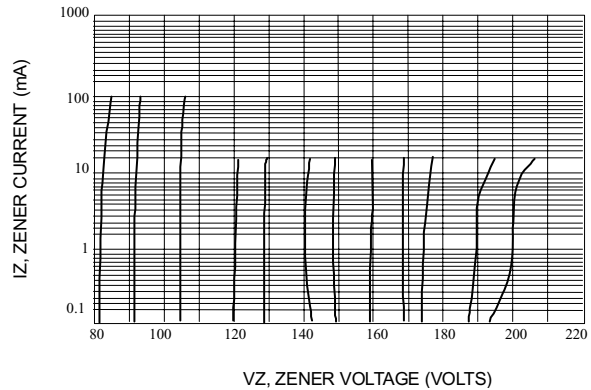

Fig. 9-ZENER VOLTAGE VERSUS ZENER CURRENT VZ = 82 THRU 200 VOLTS

Data of Figure 3 should not be used to compute surge capability. Surge limitations are given in Figure 5. They are lower than would be expected by considering only junction temperature, as current crowding effects cause temperatures to be extremely high in small spots resulting in device degradation should the limits of Figure. 5 be exceeded