

# BFP620F

## Low profile high gain silicon NPN RF bipolar transistor



Order now



Technical documents



Simulation



Support

## Product description

The BFP620F is a RF bipolar transistor based on SiGe:C technology that is part of Infineon's established sixth generation transistor family. Its high gain and low noise characteristics make the device suitable for frequencies as high as 6 GHz. It remains cost competitive without compromising on ease of use.



## Feature list

- Minimum noise figure  $NF_{min} = 0.7$  dB at 1.8 GHz, 1.5 V, 5 mA
- High gain  $G_{ms} = 21$  dB at 1.8 GHz, 1.5 V, 50 mA
- $OIP_3 = 25$  dBm at 1.8 GHz, 2 V, 50 mA

## Product validation

Qualified for industrial applications according to the relevant tests of JEDEC47/20/22.

## Potential applications

- Low noise amplifiers (LNAs) in SDARS receivers
- LNAs for wireless communications
- LNAs for ISM band applications

## Device information

**Table 1** Part information

Product name / Ordering code	Package	Pin configuration				Marking	Pieces / Reel
BFP620F / BFP620FH7764XTSA1	TSFP-4-1	1 = B	2 = E	3 = C	4 = E	R2s	3000

**Attention:** ESD (Electrostatic discharge) sensitive device, observe handling precautions

---

**Table of contents**

**Table of contents**

	<b>Product description</b> .....	1
	<b>Feature list</b> .....	1
	<b>Product validation</b> .....	1
	<b>Potential applications</b> .....	1
	<b>Device information</b> .....	1
	<b>Table of contents</b> .....	2
<b>1</b>	<b>Absolute maximum ratings</b> .....	3
<b>2</b>	<b>Thermal characteristics</b> .....	4
<b>3</b>	<b>Electrical characteristics</b> .....	6
3.1	DC characteristics .....	6
3.2	General AC characteristics .....	6
3.3	Frequency dependent AC characteristics .....	7
3.4	Characteristic AC diagrams .....	8
<b>4</b>	<b>Package information TSFP-4-1</b> .....	13
	<b>Revision history</b> .....	14
	<b>Disclaimer</b> .....	15

**Absolute maximum ratings**

**1 Absolute maximum ratings**

**Table 2 Absolute maximum ratings at  $T_A = 25\text{ °C}$  (unless otherwise specified)**

Parameter	Symbol	Values		Unit	Note or test condition
		Min.	Max.		
Collector emitter voltage	$V_{CEO}$	-	2.3	V	Open base
			2.1		$T_A = -55\text{ °C}$ , open base
Collector emitter voltage	$V_{CES}$		7.5		E-B short circuited
Collector base voltage	$V_{CBO}$		7.5		Open emitter
Emitter base voltage	$V_{EBO}$		1.2		Open collector
Base current	$I_B$		3	mA	-
Collector current	$I_C$		80		
Total power dissipation <sup>1)</sup>	$P_{tot}$		185	mW	$T_S \leq 96\text{ °C}$
Junction temperature	$T_J$		150	°C	-
Storage temperature	$T_{Stg}$	-55			

**Attention:** *Stresses above the max. values listed here may cause permanent damage to the device. Exposure to absolute maximum rating conditions for extended periods may affect device reliability. Exceeding only one of these values may cause irreversible damage to the integrated circuit.*

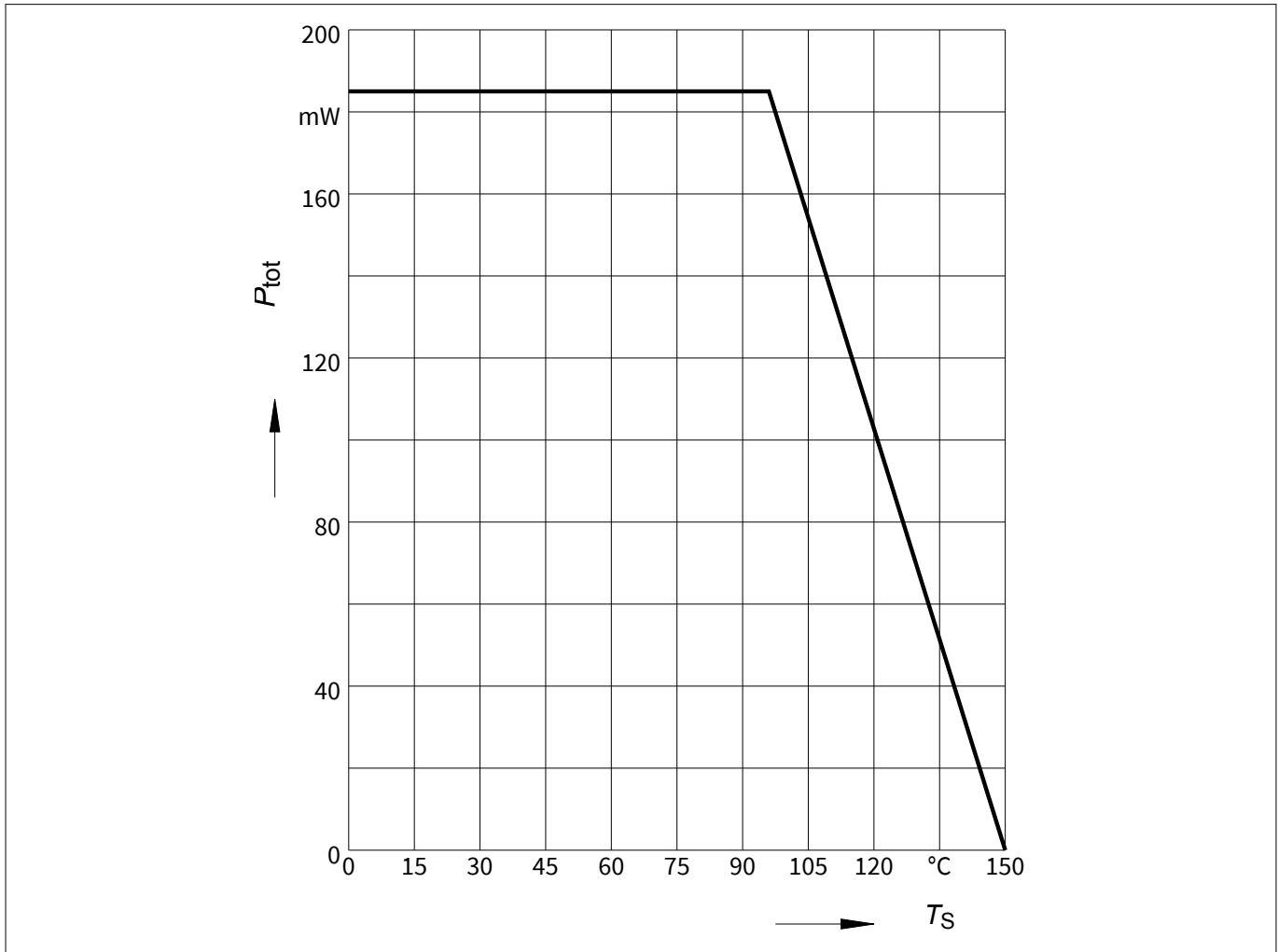
<sup>1</sup>  $T_S$  is the soldering point temperature.  $T_S$  is measured on the emitter lead at the soldering point of the PCB.

Thermal characteristics

## 2 Thermal characteristics

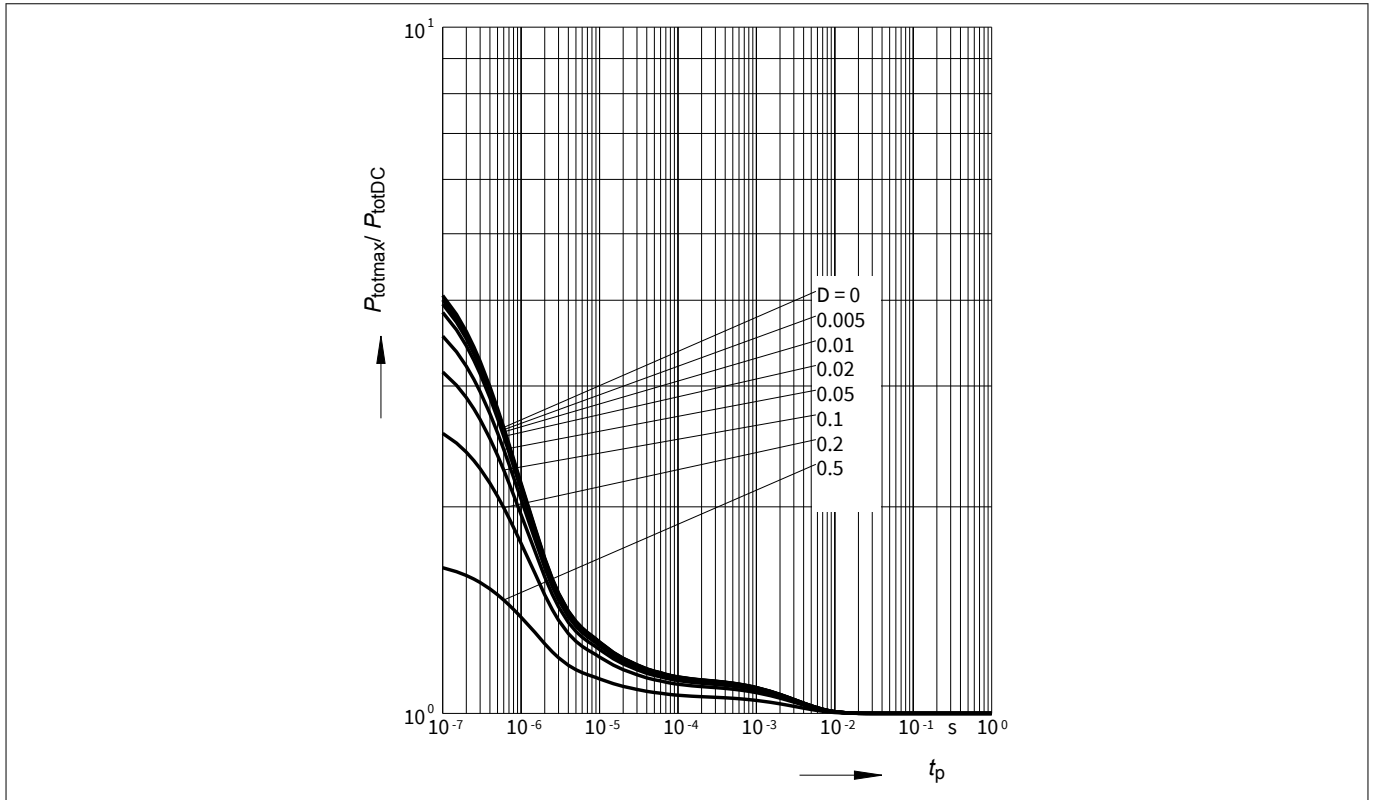
**Table 3 Thermal resistance**

Parameter	Symbol	Values			Unit	Note or test condition
		Min.	Typ.	Max.		
Junction - soldering point	$R_{thJS}$	-	290	-	K/W	-

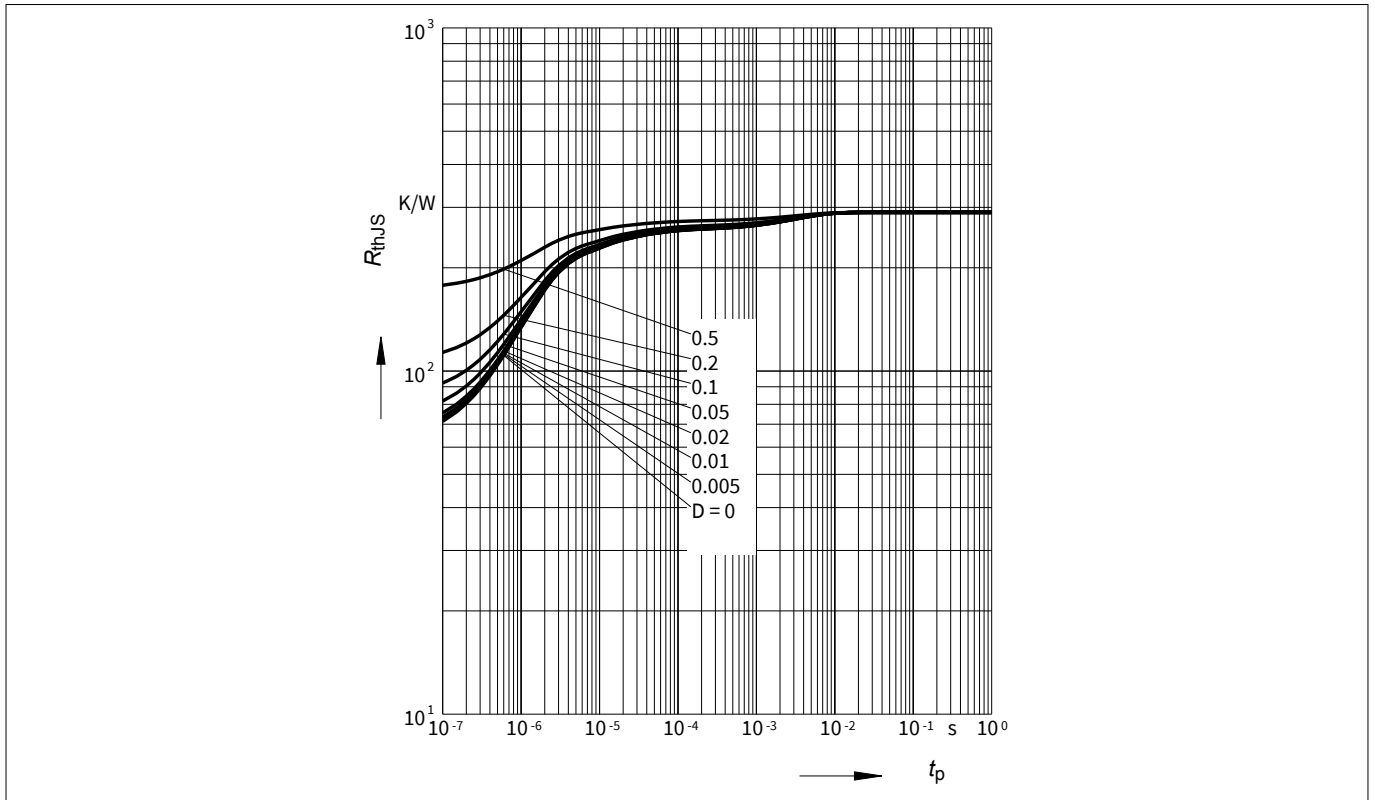


**Figure 1 Total power dissipation  $P_{tot} = f(T_s)$**

**Thermal characteristics**



**Figure 2** Permissible pulse load  $P_{tot,max} / P_{tot,DC} = f(t_p)$



**Figure 3** Permissible pulse load  $R_{thJS} = f(t_p)$

**Electrical characteristics**

**3 Electrical characteristics**

**3.1 DC characteristics**

**Table 4 DC characteristics at  $T_A = 25\text{ °C}$**

Parameter	Symbol	Values			Unit	Note or test condition
		Min.	Typ.	Max.		
Collector emitter breakdown voltage	$V_{(BR)CEO}$	2.3	2.8	–	V	$I_C = 1\text{ mA}$ , $I_B = 0$ , open base
Collector emitter leakage current	$I_{CES}$	–	–	10 <sup>2)</sup>	μA	$V_{CE} = 7.5\text{ V}$ , $V_{BE} = 0$ , E-B short circuited
Collector base leakage current	$I_{CBO}$			100 <sup>2)</sup>	nA	$V_{CB} = 5\text{ V}$ , $I_E = 0$ , open emitter
Emitter base leakage current	$I_{EBO}$			3 <sup>2)</sup>	μA	$V_{EB} = 0.5\text{ V}$ , $I_C = 0$ , open collector
DC current gain	$h_{FE}$	110	180	270		$V_{CE} = 1.5\text{ V}$ , $I_C = 50\text{ mA}$ , pulse measured

**3.2 General AC characteristics**

**Table 5 General AC characteristics at  $T_A = 25\text{ °C}$**

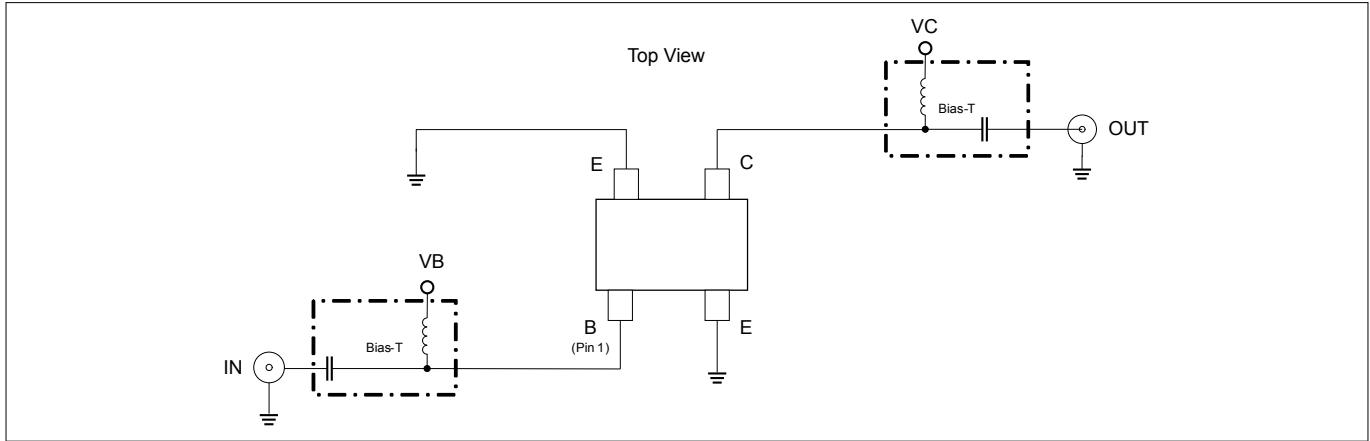
Parameter	Symbol	Values			Unit	Note or test condition
		Min.	Typ.	Max.		
Transition frequency	$f_T$	–	65	–	GHz	$V_{CE} = 1.5\text{ V}$ , $I_C = 50\text{ mA}$ , $f = 1\text{ GHz}$
Collector base capacitance	$C_{CB}$		0.12	0.2	pF	$V_{CB} = 2\text{ V}$ , $V_{BE} = 0$ , $f = 1\text{ MHz}$ , emitter grounded
Collector emitter capacitance	$C_{CE}$		0.2	–		$V_{CE} = 2\text{ V}$ , $V_{BE} = 0$ , $f = 1\text{ MHz}$ , base grounded
Emitter base capacitance	$C_{EB}$		0.45			$V_{EB} = 0.5\text{ V}$ , $V_{CB} = 0$ , $f = 1\text{ MHz}$ , collector grounded

<sup>2</sup> Maximum values not limited by the device but by the short cycle time of the 100% test.

**Electrical characteristics**

**3.3 Frequency dependent AC characteristics**

Measurement setup is a test fixture with Bias-T's in a 50 Ω system,  $T_A = 25\text{ °C}$ .



**Figure 4 Testing circuit**

**Table 6 AC characteristics,  $V_{CE} = 1.5\text{ V}$ ,  $f = 1.8\text{ GHz}$**

Parameter	Symbol	Values			Unit	Note or test condition
		Min.	Typ.	Max.		
Power gain		-		-	dB	$I_C = 50\text{ mA}$
<ul style="list-style-type: none"> <li>Maximum power gain</li> <li>Transducer gain</li> </ul>	$G_{ms}$ $ S_{21} ^2$		21 19.5			
Noise figure						
<ul style="list-style-type: none"> <li>Minimum noise figure</li> </ul>	$NF_{min}$		0.7			$I_C = 5\text{ mA}$
Linearity					dBm	$I_C = 50\text{ mA}$ , $V_{CE} = 2\text{ V}$ , $Z_S = Z_L = 50\text{ }\Omega$
<ul style="list-style-type: none"> <li>3rd order intercept point at output</li> <li>1 dB gain compression point at output</li> </ul>	$OIP_3$ $OP_{1dB}$		25 14			

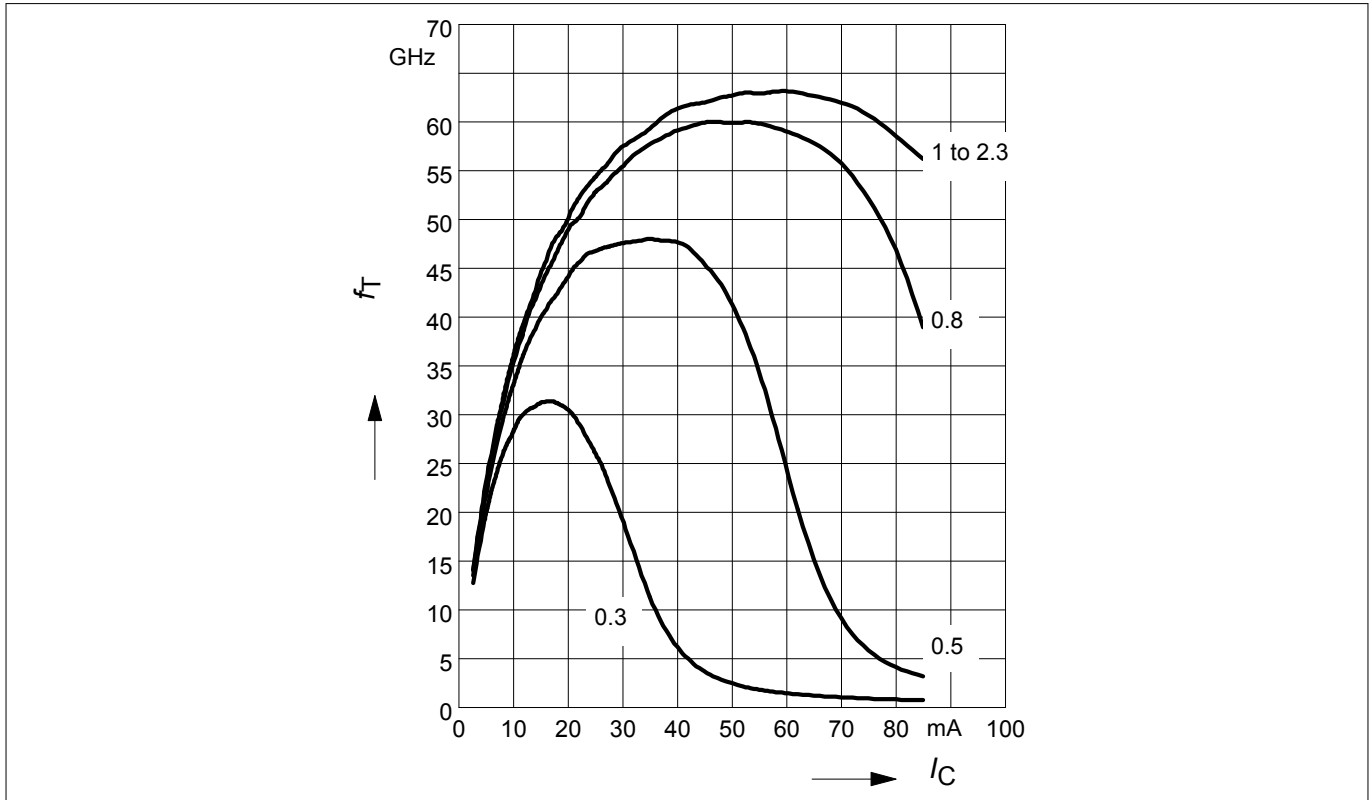
**Table 7 AC characteristics,  $V_{CE} = 1.5\text{ V}$ ,  $f = 6\text{ GHz}$**

Parameter	Symbol	Values			Unit	Note or test condition
		Min.	Typ.	Max.		
Power gain		-		-	dB	$I_C = 50\text{ mA}$
<ul style="list-style-type: none"> <li>Maximum power gain</li> <li>Transducer gain</li> </ul>	$G_{ma}$ $ S_{21} ^2$		10 9.5			
Noise figure						
<ul style="list-style-type: none"> <li>Minimum noise figure</li> </ul>	$NF_{min}$		1.3			$I_C = 5\text{ mA}$

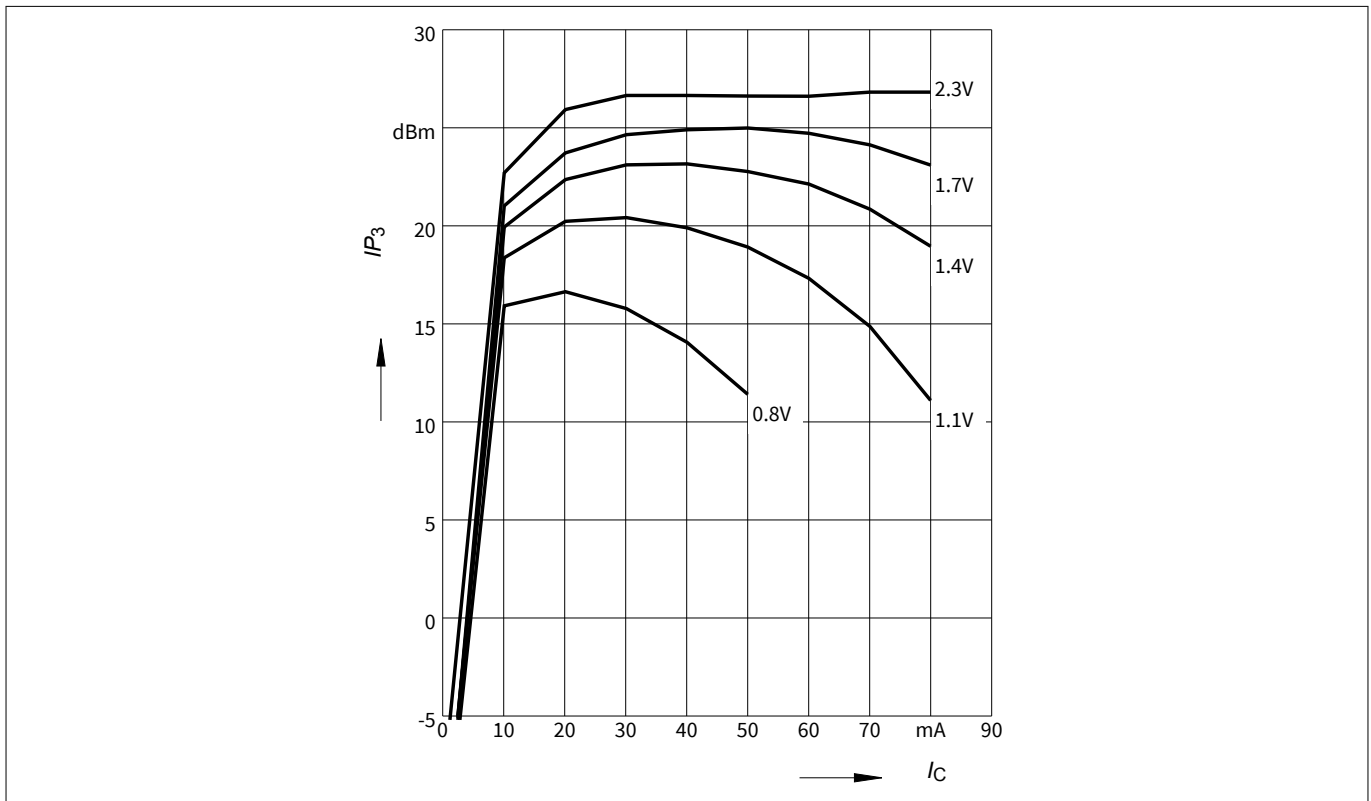
Note:  $G_{ms} = |S_{21} / S_{12}|$  for  $k < 1$ ;  $G_{ma} = |S_{21} / S_{12}| (k - (k^2 - 1)^{1/2})$  for  $k > 1$ . In order to get the  $NF_{min}$  values stated in this chapter, the test fixture losses have been subtracted from all measured results.  $OIP_3$  value depends on termination of all intermodulation frequency components. Termination used for this measurement is 50 Ω from 0.1 MHz to 6 GHz.

Electrical characteristics

**3.4 Characteristic AC diagrams**



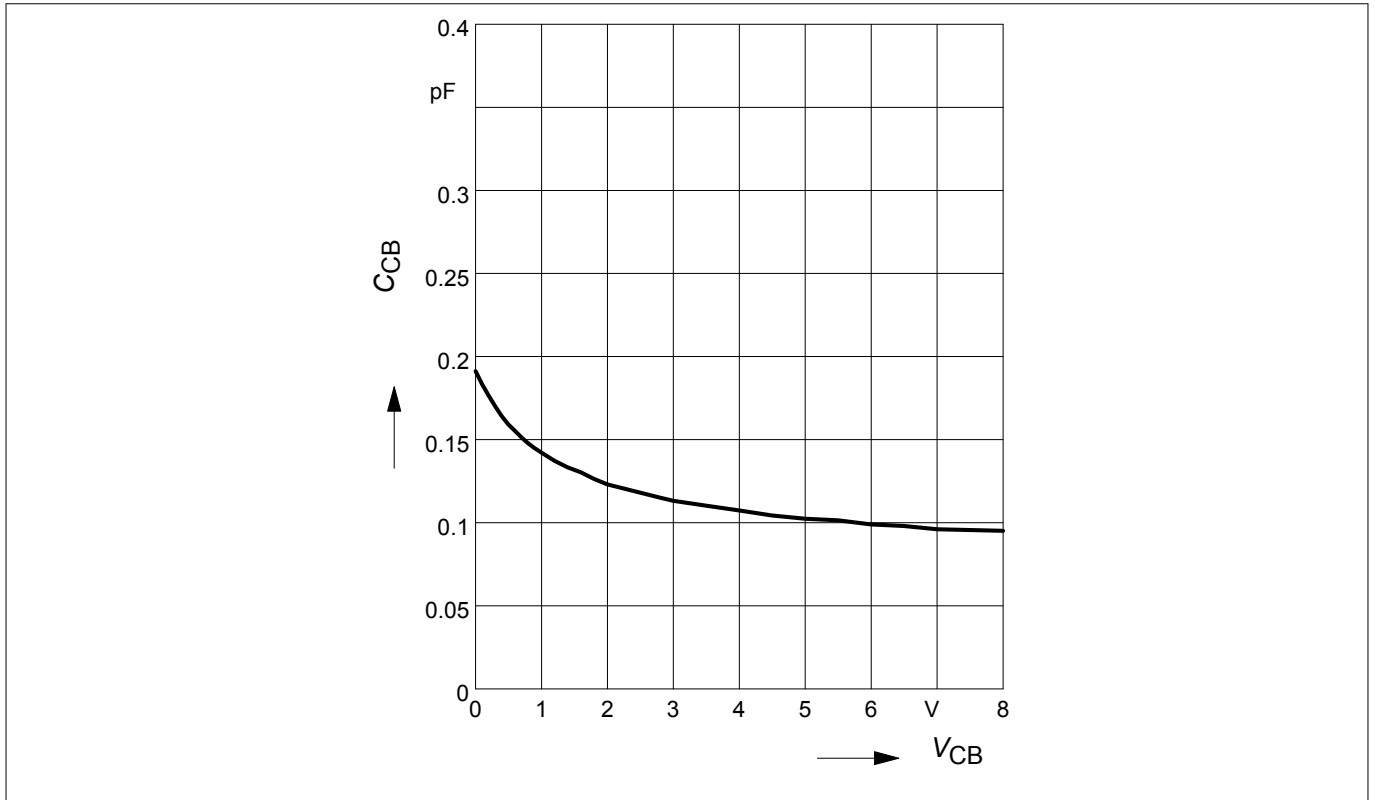
**Figure 5** Transition frequency  $f_T = f(I_C)$ ,  $f = 1 \text{ GHz}$ ,  $V_{CE} = \text{parameter in V}$



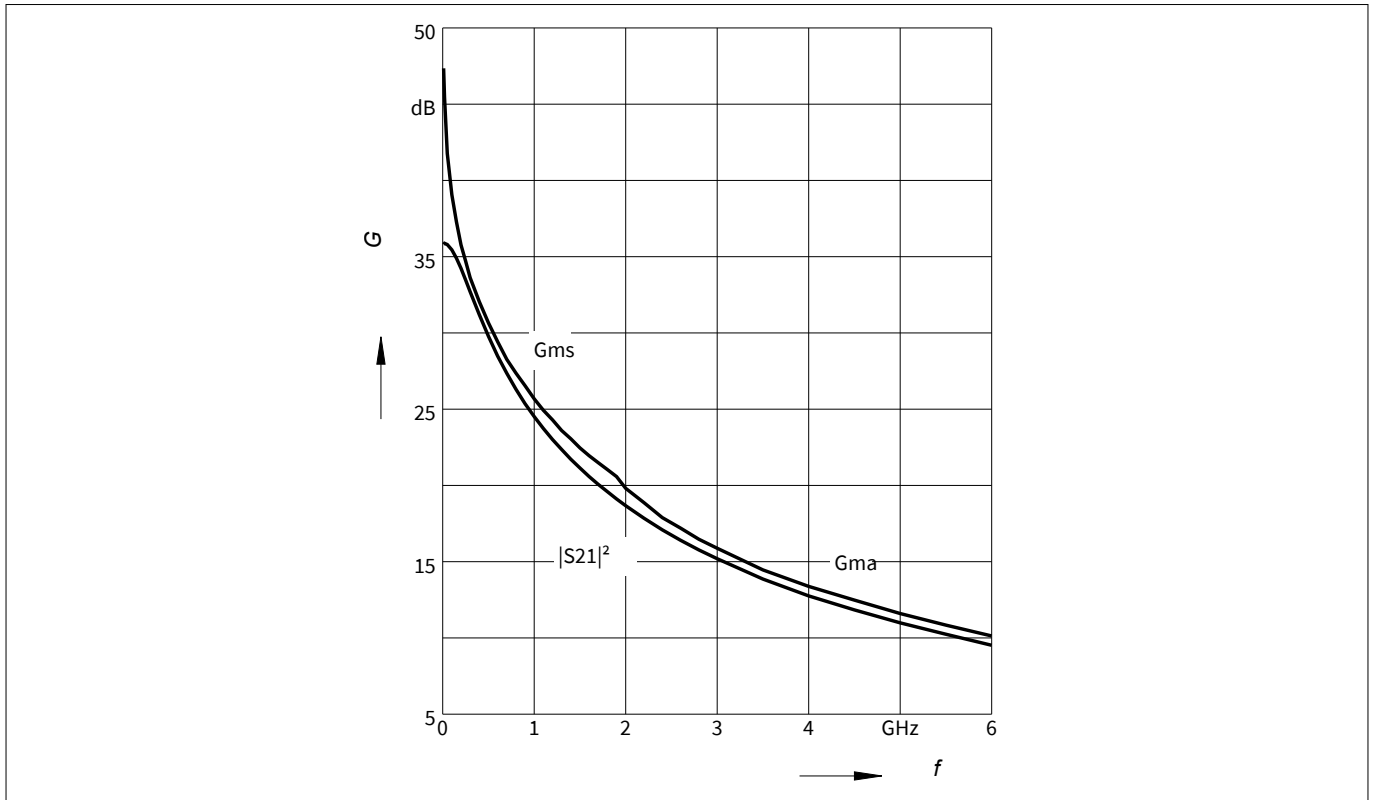
**Figure 6** 3rd order intercept point  $OIP_3 = f(I_C)$ ,  $Z_S = Z_L = 50 \Omega$ ,  $f = 1.8 \text{ GHz}$ ,  $V_{CE} = \text{parameter}$



**Electrical characteristics**

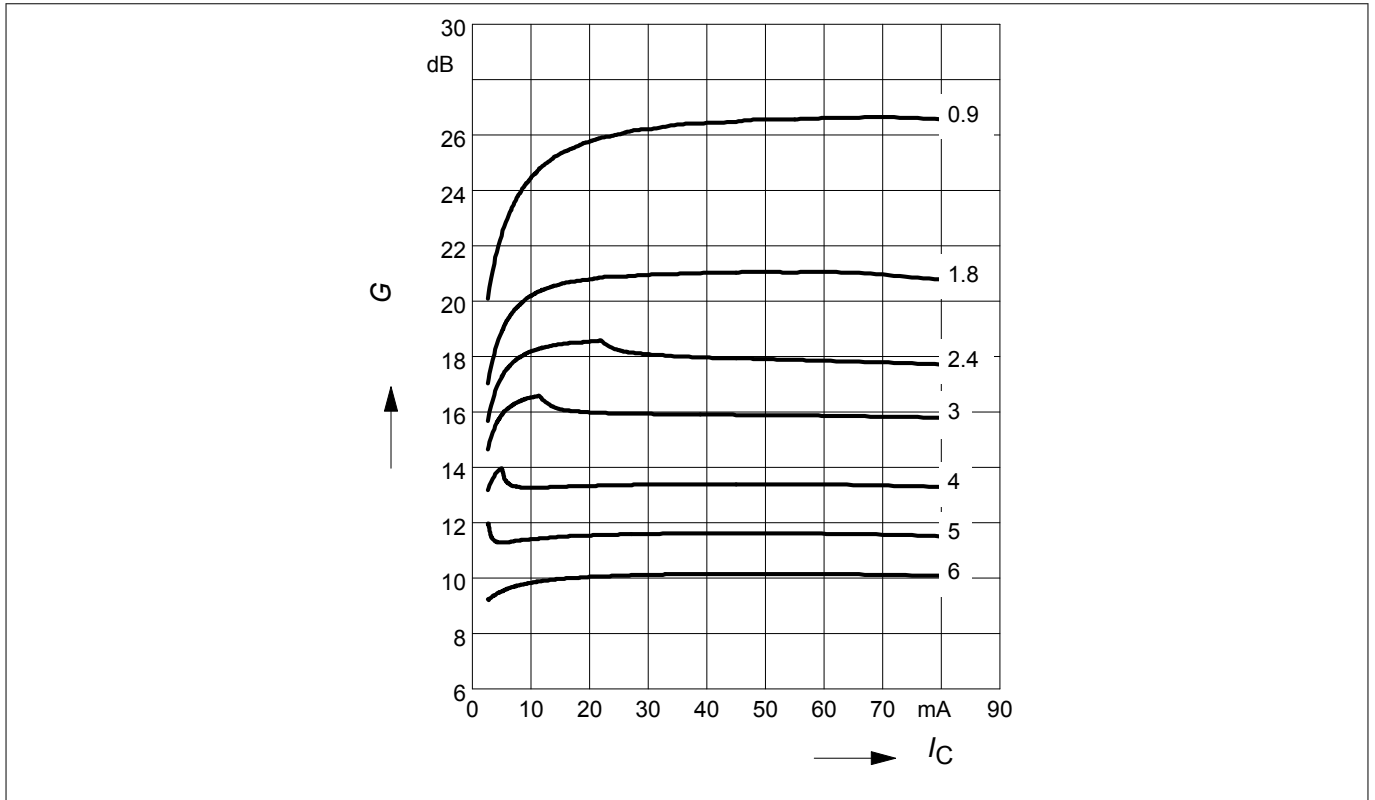


**Figure 7** Collector base capacitance  $C_{CB} = f(V_{CB})$ ,  $f = 1$  MHz

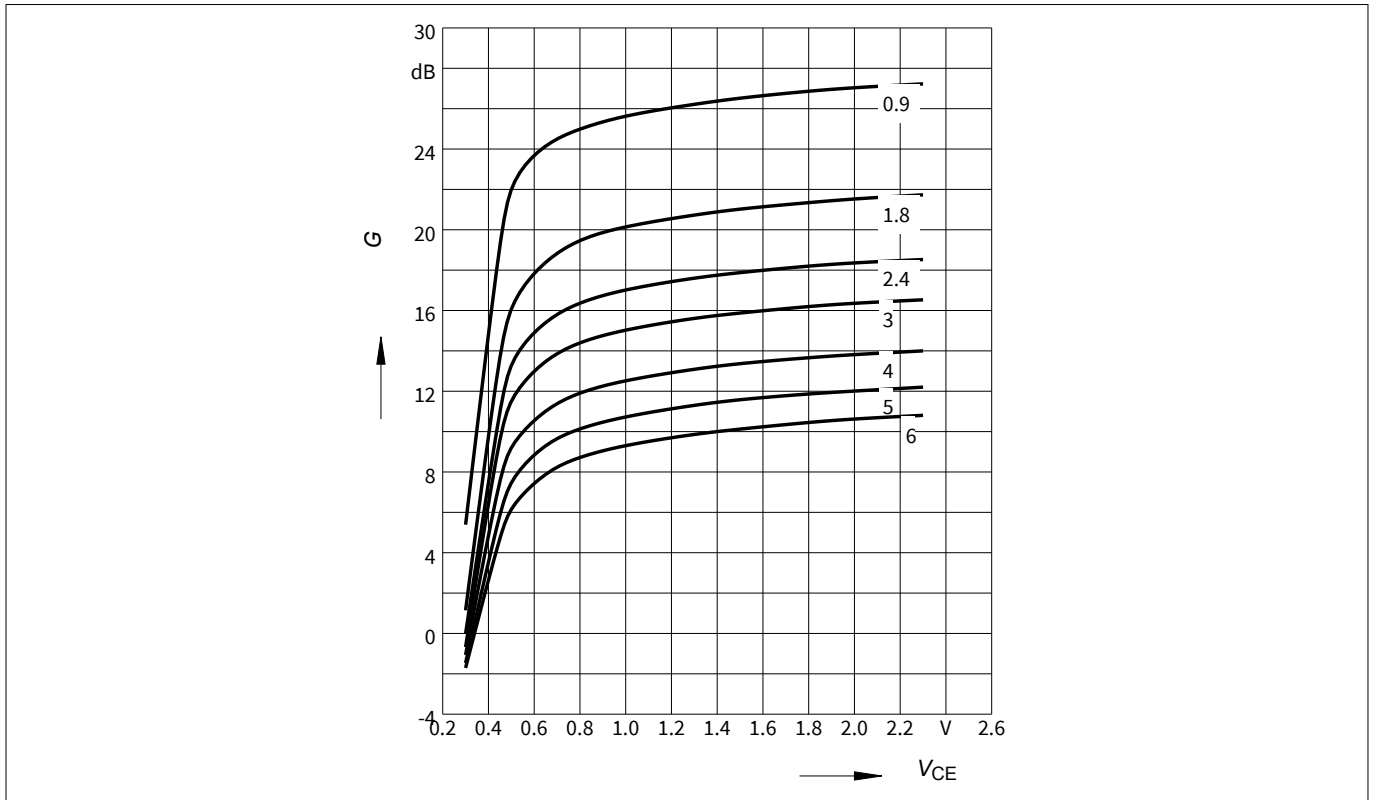


**Figure 8** Gain  $G_{ma}$ ,  $G_{ms}$ ,  $|S_{21}|^2 = f(f)$ ,  $V_{CE} = 1.5$  V,  $I_C = 50$  mA

**Electrical characteristics**

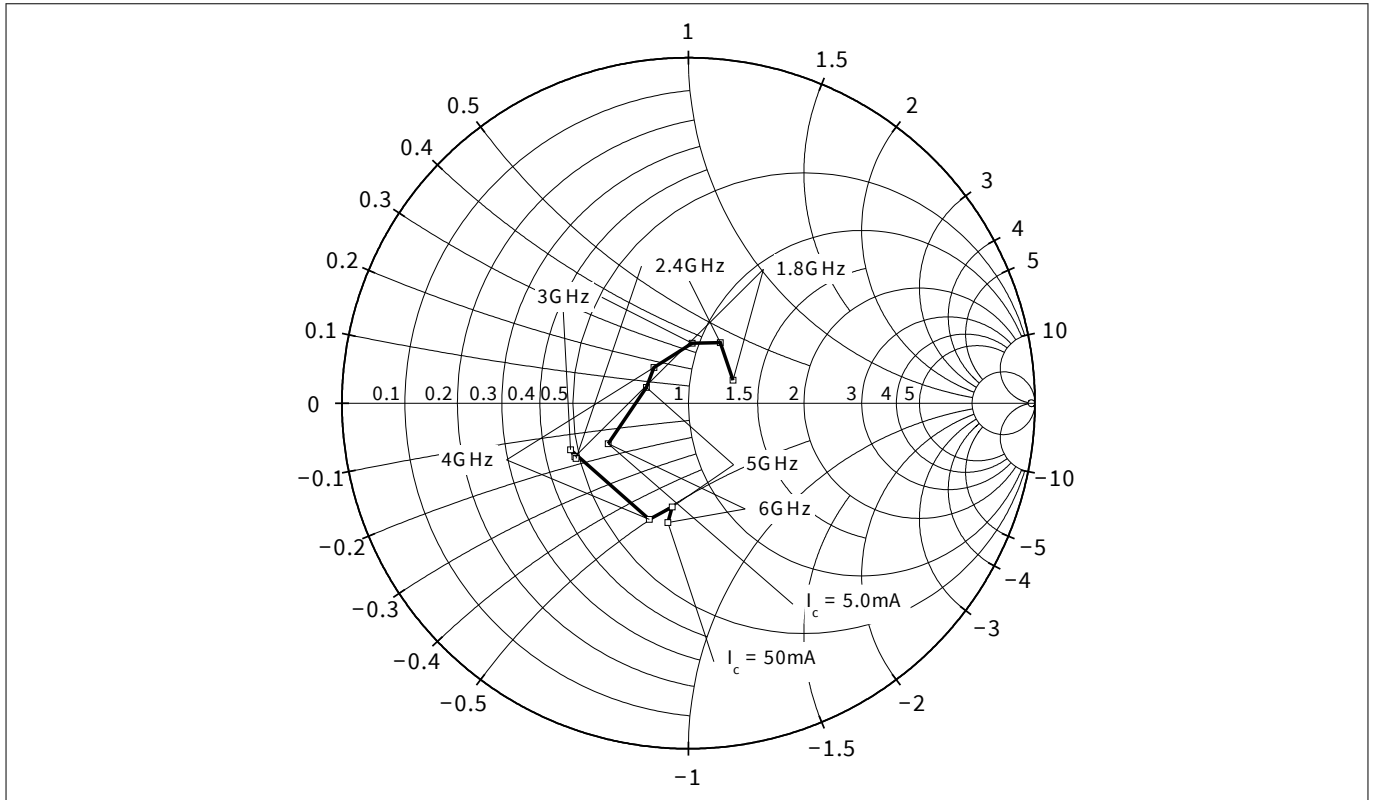


**Figure 9** Maximum power gain  $G_{max} = f(I_C)$ ,  $V_{CE} = 1.5$  V,  $f =$  parameter in GHz

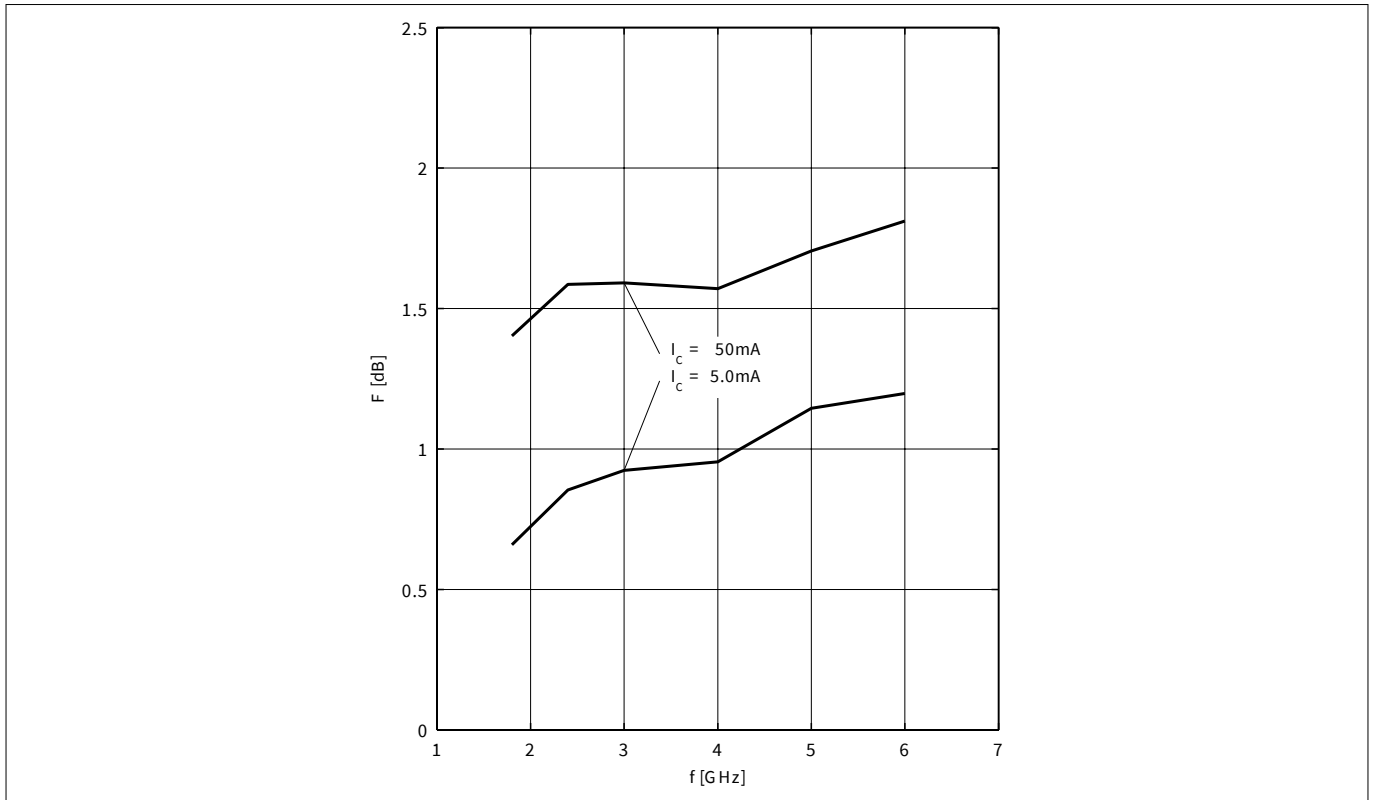


**Figure 10** Maximum power gain  $G_{max} = f(V_{CE})$ ,  $I_C = 50$  mA,  $f =$  parameter in GHz

**Electrical characteristics**

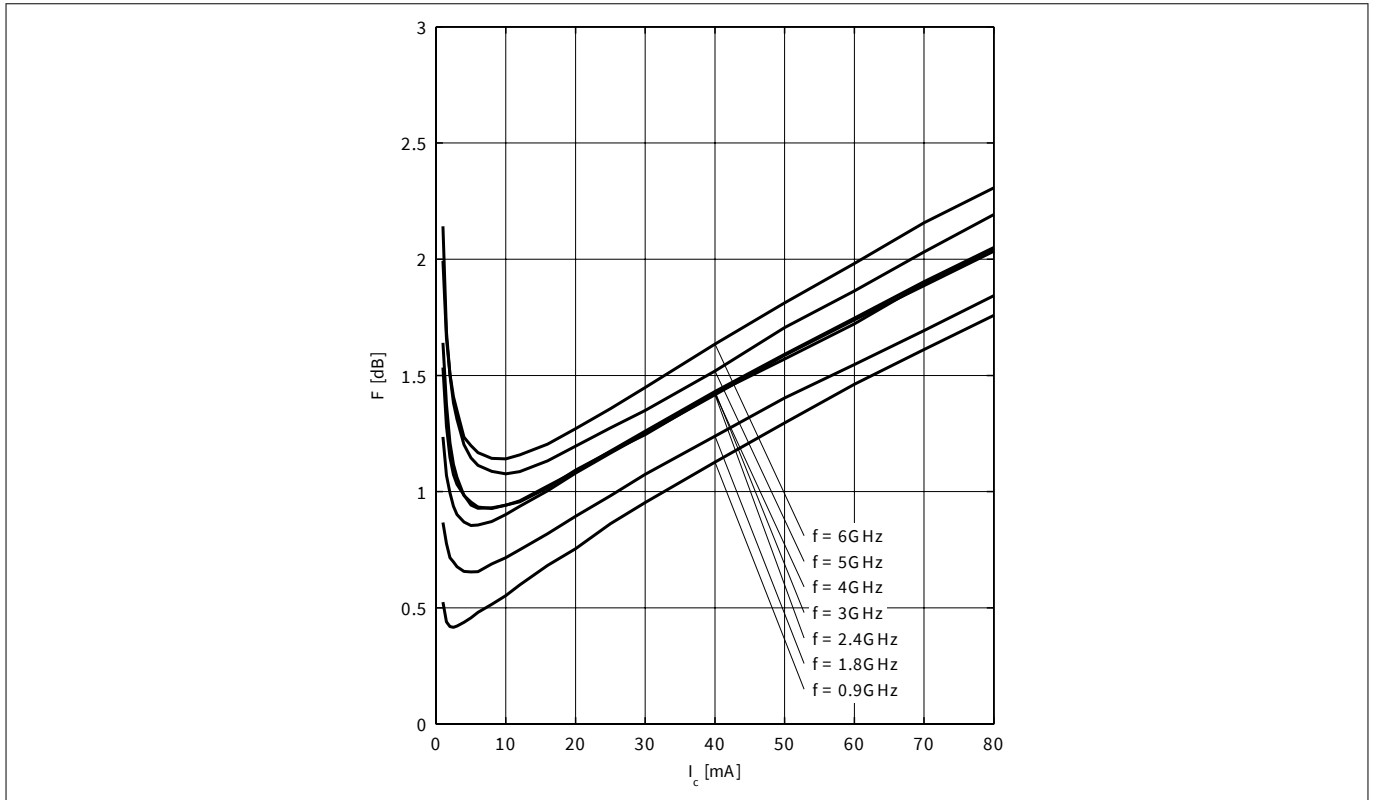


**Figure 11** Source impedance for minimum noise figure  $Z_{S,opt} = f(f)$ ,  $V_{CE} = 1.5 \text{ V}$ ,  $I_C = 5 / 50 \text{ mA}$

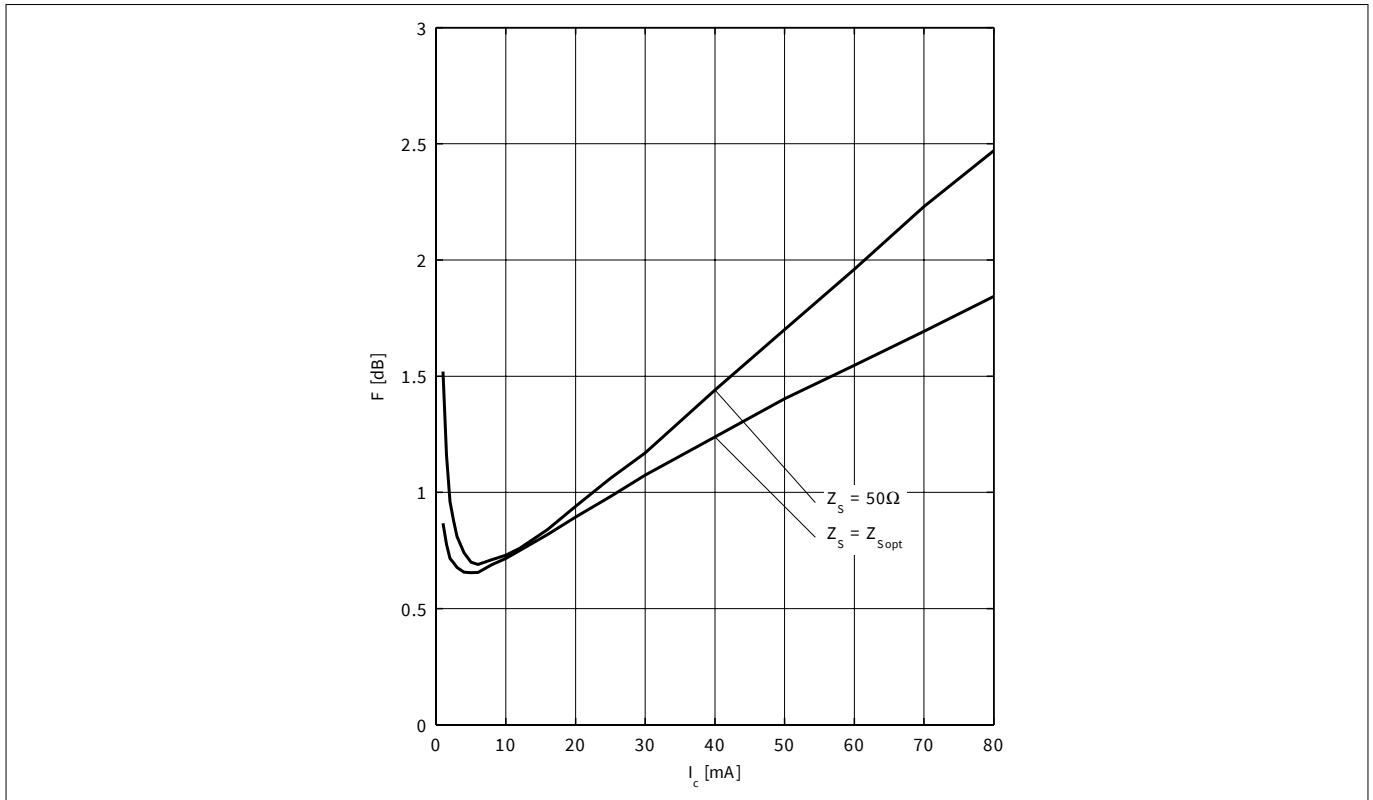


**Figure 12** Noise figure  $NF_{min} = f(f)$ ,  $Z_S = Z_{S,opt}$ ,  $V_{CE} = 1.5 \text{ V}$ ,  $I_C = 5 / 50 \text{ mA}$

**Electrical characteristics**



**Figure 13** Noise figure  $NF_{min} = f(I_C), Z_S = Z_{S,opt}, V_{CE} = 1.5 V, f = \text{parameter in GHz}$

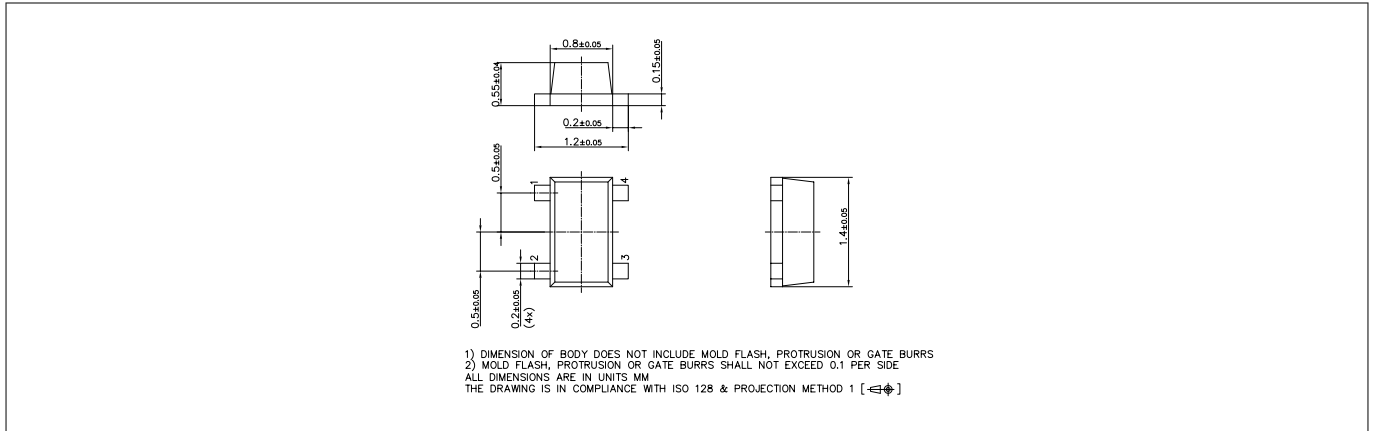


**Figure 14** Noise figure  $NF_{min} = f(I_C), Z_S = Z_{S,opt}, NF_{50} = f(I_C), Z_S = 50 \Omega, V_{CE} = 1.5 V, f = 1.8 GHz$

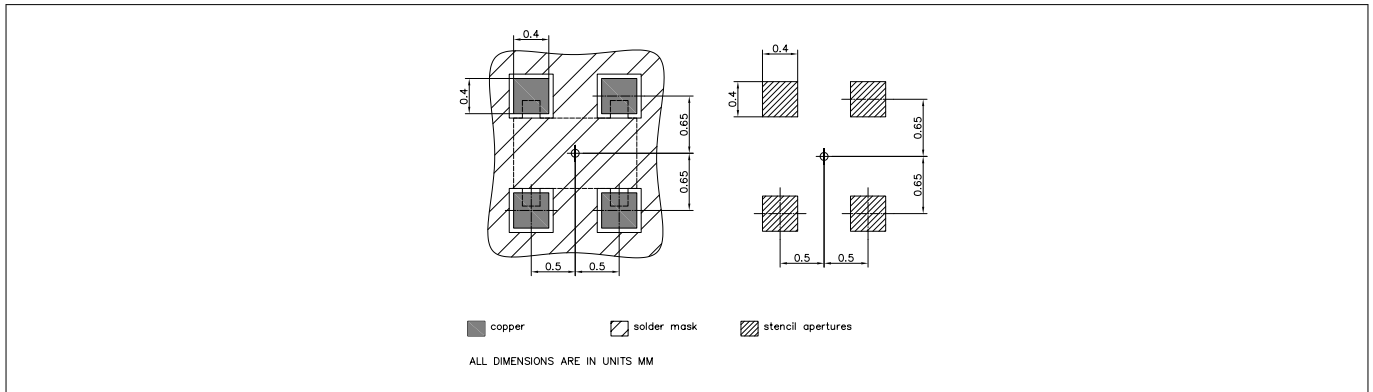
*Note:* The curves shown in this chapter have been generated using typical devices but shall not be considered as a guarantee that all devices have identical characteristic curves.  $T_A = 25^\circ C$ .

**Package information TSFP-4-1**

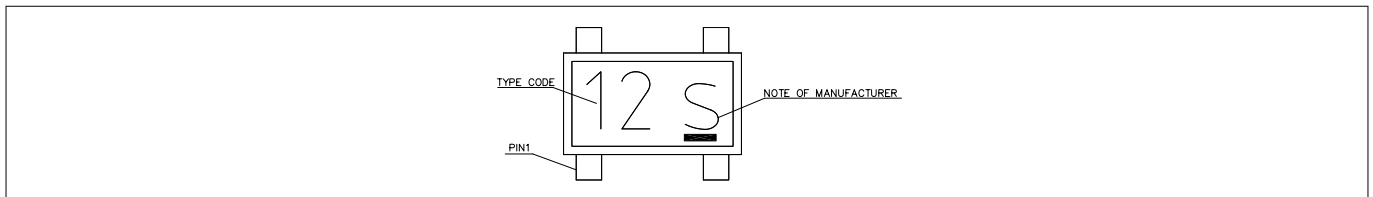
**4 Package information TSFP-4-1**



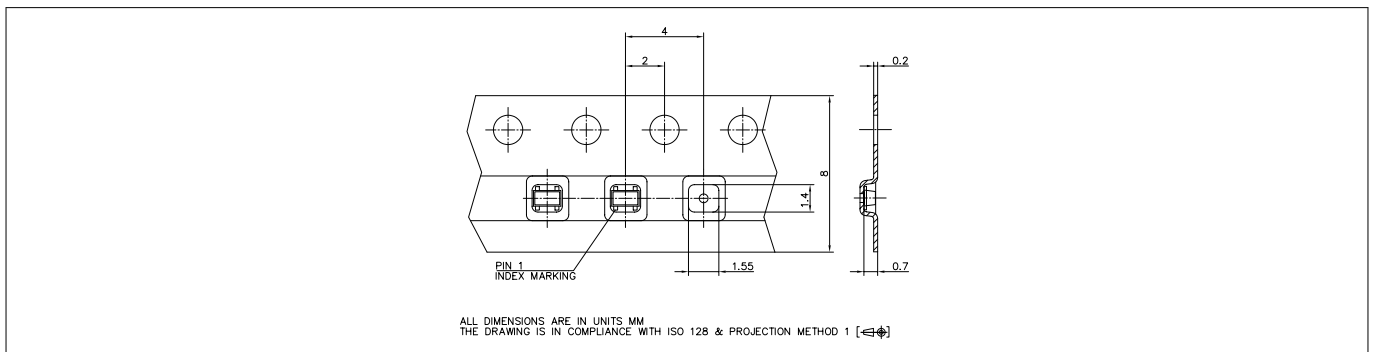
**Figure 15 Package outline**



**Figure 16 Foot print**



**Figure 17 Marking layout example**



**Figure 18 Tape dimensions**

---

**Revision history**

**Revision history**

<b>Document version</b>	<b>Date of release</b>	<b>Description of changes</b>
Revision 2.0	2019-01-25	New datasheet layout.

## Trademarks

All referenced product or service names and trademarks are the property of their respective owners.

**Edition 2019-01-25**

**Published by**  
**Infineon Technologies AG**  
**81726 Munich, Germany**

**© 2019 Infineon Technologies AG**  
**All Rights Reserved.**

**Do you have a question about any**  
**aspect of this document?**  
**Email: [erratum@infineon.com](mailto:erratum@infineon.com)**

**Document reference**  
**IFX-kfj1526289592072**

## IMPORTANT NOTICE

The information given in this document shall in no event be regarded as a guarantee of conditions or characteristics ("Beschaffheitsgarantie").

With respect to any examples, hints or any typical values stated herein and/or any information regarding the application of the product, Infineon Technologies hereby disclaims any and all warranties and liabilities of any kind, including without limitation warranties of non-infringement of intellectual property rights of any third party.

In addition, any information given in this document is subject to customer's compliance with its obligations stated in this document and any applicable legal requirements, norms and standards concerning customer's products and any use of the product of Infineon Technologies in customer's applications.

The data contained in this document is exclusively intended for technically trained staff. It is the responsibility of customer's technical departments to evaluate the suitability of the product for the intended application and the completeness of the product information given in this document with respect to such application.

## WARNINGS

Due to technical requirements products may contain dangerous substances. For information on the types in question please contact your nearest Infineon Technologies office.

Except as otherwise explicitly approved by Infineon Technologies in a written document signed by authorized representatives of Infineon Technologies, Infineon Technologies' products may not be used in any applications where a failure of the product or any consequences of the use thereof can reasonably be expected to result in personal injury