

Rochester Electronics Manufactured Components

Rochester branded components are manufactured using either die/wafers purchased from the original suppliers or Rochester wafers recreated from the original IP. All recreations are done with the approval of the OCM.

Parts are tested using original factory test programs or Rochester developed test solutions to guarantee product meets or exceed the OCM data sheet.

Quality Overview

- ISO-9001
- AS9120 certification
- Qualified Manufacturers List (QML) MIL-PRF-35835
 - Class Q Military
 - Class V Space Level
- Qualified Suppliers List of Distributors (QSLD)
 - Rochester is a critical supplier to DLA and meets all industry and DLA standards.

Rochester Electronics, LLC is committed to supplying products that satisfy customer expectations for quality and are equal to those originally supplied by industry manufacturers.

The original manufacturer's datasheet accompanying this document reflects the performance and specifications of the Rochester manufactured version of this device. Rochester Electronics guarantees the performance of its semiconductor products to the original OEM specifications. 'Typical' values are for reference purposes only. Certain minimum or maximum ratings may be based on product characterization, design, simulation, or sample testing.

November 1996

Features

- Wide Operating Voltage Range..... $\pm 1\text{V}$ to $\pm 8\text{V}$
- High Input Impedance $10^{12}\Omega$
- Input Current Lower Than BIFETs 1pA (Typ)
- Output Voltage Swing $V+$ and $V-$
- Available as Duals and Quads (Refer to ICL7611 for Singles)
- Low Power Replacement for Many Standard Op Amps

Applications

- Portable Instruments
- Telephone Headsets
- Hearing Aid/Microphone Amplifiers
- Meter Amplifiers
- Medical Instruments
- High Impedance Buffers

Description

The ICL761X/762X/764X series is a family of monolithic CMOS operational amplifiers. These devices provide the designer with high performance operation at low supply voltages and selectable quiescent currents. They are an ideal design tool when ultra low input current and low power dissipation are desired.

The basic amplifier will operate at supply voltages ranging from $\pm 1\text{V}$ to $\pm 8\text{V}$, and may be operated from a single Lithium cell. The output swing ranges to within a few millivolts of the supply voltages.

The quiescent supply current of these amplifiers is set to 3 different ranges at the factory. Both amps of the dual ICL7621 are set to an I_Q of $100\mu\text{A}$, while each amplifier of the quad ICL7641 and ICL7642 are set to an I_Q of 1mA and $10\mu\text{A}$ respectively. This results in power consumption as low as $20\mu\text{W}$ per amplifier.

Of particular significance is the extremely low (1pA) input current, input noise current of $0.01\text{pA}/\sqrt{\text{Hz}}$, and $10^{12}\Omega$ input impedance. These features optimize performance in very high source impedance applications.

The inputs are internally protected. Outputs are fully protected against short circuits to ground or to either supply.

AC performance is excellent, with a slew rate of $1.6\text{V}/\mu\text{s}$, and unity gain bandwidth of 1MHz at $I_Q = 1\text{mA}$.

Because of the low power dissipation, junction temperature rise and drift are quite low. Applications utilizing these features may include stable instruments, extended life designs, or high density packages.

Pinouts (See Ordering Information on Next Page)

ICL7621
(PDIP, SOIC)
TOP VIEW

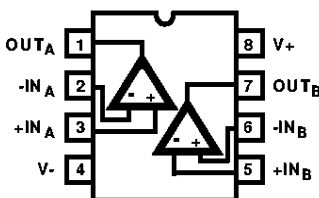

ICL7621
(METAL CAN)
TOP VIEW

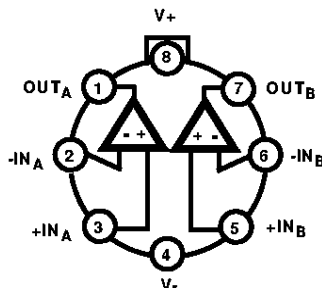

ICL7641 (PDIP)
ICL7642 (PDIP)
TOP VIEW

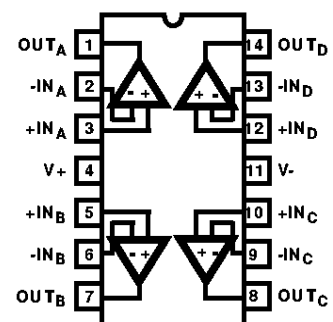

ICL7621, ICL7641, ICL7642**Ordering Information**

PART NUMBER	TEMP. RANGE (°C)	PACKAGE	PKG. NO.
ICL7621ACPA	0 to 70	8 Ld PDIP - A Grade - $I_Q = 100\mu A$	E8.3
ICL7621BCPA	0 to 70	8 Ld PDIP - B Grade - $I_Q = 100\mu A$	E8.3
ICL7621DCPA	0 to 70	8 Ld PDIP - D Grade - $I_Q = 100\mu A$	E8.3
ICL7621BCTV	0 to 70	8 Pin Metal Can - B Grade - $I_Q = 100\mu A$	T8.C
ICL7621DCTV	0 to 70	8 Pin Metal Can - D Grade - $I_Q = 100\mu A$	T8.C
ICL7621AMTV	-55 to 125	8 Pin Metal Can - A Grade - $I_Q = 100\mu A$	T8.C
ICL7621BMTV	-55 to 125	8 Pin Metal Can - B Grade - $I_Q = 100\mu A$	T8.C
ICL7621DMTV	-55 to 125	8 Pin Metal Can - D Grade - $I_Q = 100\mu A$	T8.C
ICL7621DCBA	0 to 70	8 Ld SOIC - D Grade - $I_Q = 100\mu A$	M8.15
ICL7621DCBA-T	0 to 70	8 Ld SOIC - D Grade - Tape and Reel - $I_Q = 100\mu A$	M8.15
ICL7641CCPD	0 to 70	14 Ld PDIP - C Grade - $I_Q = 1mA$	E14.3
ICL7641ECPD	0 to 70	14 Ld PDIP - E Grade - $I_Q = 1mA$	E14.3
ICL7642CCPD	0 to 70	14 Ld PDIP - C Grade - $I_Q = 10\mu A$	E14.3
ICL7642ECPD	0 to 70	14 Ld PDIP - E Grade - $I_Q = 10\mu A$	E14.3

ICL7621, ICL7641, ICL7642

Absolute Maximum Ratings

Supply Voltage V_+ to V_- 18V
 Input Voltage $V_- - 0.3$ to $V_+ + 0.3$ V
 Differential Input Voltage (Note 1) $[(V_+ + 0.3) - (V_- - 0.3)]$ V
 Duration of Output Short Circuit (Note 2) Unlimited

Operating Conditions

Temperature Range
 ICL76XXM -55°C to 125°C
 ICL76XXC 0°C to 70°C

Thermal Information

Thermal Resistance (Typical, Note 3) θ_{JA} ($^{\circ}\text{C}/\text{W}$) θ_{JC} ($^{\circ}\text{C}/\text{W}$)
 SOIC Package 160 N/A
 Metal Can Package 160 75
 8 Lead PDIP Package 120 N/A
 14 Lead PDIP Package 80 N/A
 Maximum Junction Temperature (Hermetic Packages) 175°C
 Maximum Junction Temperature (Plastic Package) 150°C
 Maximum Storage Temperature Range -65°C to 150°C
 Maximum Lead Temperature (Soldering 10s) 300°C
 (SOIC - Lead Tips Only)

CAUTION: Stresses above those listed in "Absolute Maximum Ratings" may cause permanent damage to the device. This is a stress only rating and operation of the device at these or any other conditions above those indicated in the operational sections of this specification is not implied.

NOTES:

1. Long term offset voltage stability will be degraded if large input differential voltages are applied for long periods of time.
2. The outputs may be shorted to ground or to either supply, for $V_{\text{SUPPLY}} \leq 10\text{V}$. Care must be taken to insure that the dissipation rating is not exceeded.
3. θ_{JA} is measured with the component mounted on an evaluation PC board in free air.

Electrical Specifications $V_{\text{SUPPLY}} = \pm 5\text{V}$, Unless Otherwise Specified

PARAMETER	SYMBOL	TEST CONDITIONS	TEMP. ($^{\circ}\text{C}$)	ICL7621A			ICL7621B			ICL7621D			UNITS
				MIN	TYP	MAX	MIN	TYP	MAX	MIN	TYP	MAX	
Input Offset Voltage	V_{OS}	$R_S \leq 100\text{k}\Omega$	25	-	-	2	-	-	5	-	-	15	mV
			Full	-	-	3	-	-	7	-	-	20	mV
Temperature Coefficient of V_{OS}	$\Delta V_{\text{OS}}/\Delta T$	$R_S \leq 100\text{k}\Omega$	-	-	10	-	-	15	-	-	25	-	$\mu\text{V}/^{\circ}\text{C}$
Input Offset Current	I_{OS}		25	-	0.5	30	-	0.5	30	-	0.5	30	pA
			0 to 70	-	-	300	-	-	300	-	-	300	pA
			-55 to 125	-	-	800	-	-	800	-	-	800	pA
Input Bias Current	I_{BIAS}		25	-	1.0	50	-	1.0	50	-	1.0	50	pA
			0 to 70	-	-	400	-	-	400	-	-	400	pA
			-55 to 125	-	-	4000	-	-	4000	-	-	4000	pA
Common Mode Voltage Range	V_{CMR}	$I_Q = 100\mu\text{A}$	25	± 4.2	-	-	± 4.2	-	-	± 4.2	-	-	V
Output Voltage Swing	V_{OUT}	$I_Q = 100\mu\text{A}$, $R_L = 100\text{k}\Omega$,	25	± 4.9	-	-	± 4.9	-	-	± 4.9	-	-	V
			0 to 70	± 4.8	-	-	± 4.8	-	-	± 4.8	-	-	V
			-55 to 125	± 4.5	-	-	± 4.5	-	-	± 4.5	-	-	V
Large Signal Voltage Gain	A_{VOL}	$V_O = \pm 4.0\text{V}$, $R_L = 100\text{k}\Omega$, $I_Q = 100\mu\text{A}$	25	86	102	-	80	102	-	80	102	-	dB
			0 to 70	80	-	-	75	-	-	75	-	-	dB
			-55 to 125	74	-	-	68	-	-	68	-	-	dB
Unity Gain Bandwidth	GBW	$I_Q = 100\mu\text{A}$	25	-	0.48	-	-	0.48	-	-	0.48	-	MHz
Input Resistance	R_{IN}		25	-	10^{12}	-	-	10^{12}	-	-	10^{12}	-	Ω
Common Mode Rejection Ratio	CMRR	$R_S \leq 100\text{k}\Omega$, $I_Q = 100\mu\text{A}$	25	76	91	-	70	91	-	70	91	-	dB
Power Supply Rejection Ratio ($V_{\text{SUPPLY}} = \pm 8\text{V}$ to $\pm 2\text{V}$)	PSRR	$R_S \leq 100\text{k}\Omega$, $I_Q = 100\mu\text{A}$	25	80	86	-	80	86	-	80	86	-	dB
Input Referred Noise Voltage	e_N	$R_S = 100\Omega$, $f = 1\text{kHz}$	25	-	100	-	-	100	-	-	100	-	$\text{nV}/\sqrt{\text{Hz}}$

ICL7621, ICL7641, ICL7642

Electrical Specifications $V_{SUPPLY} = \pm 5V$, Unless Otherwise Specified (Continued)

PARAMETER	SYMBOL	TEST CONDITIONS	TEMP. (°C)	ICL7621A			ICL7621B			ICL7621D			UNITS
				MIN	TYP	MAX	MIN	TYP	MAX	MIN	TYP	MAX	
Input Referred Noise Current	i_{IN}	$R_S = 100\Omega$, $f = 1kHz$	25	-	0.01	-	-	0.01	-	-	0.01	-	pA/\sqrt{Hz}
Supply Current (Per Amplifier)	I_{SUPPLY}	No Signal, No Load, $I_Q = 100\mu A$	25	-	0.1	0.25	-	0.1	0.25	-	0.1	0.25	mA
Channel Separation	V_{O1}/V_{O2}	$A_V = 100$	25	-	120	-	-	120	-	-	120	-	dB
Slew Rate	SR	$A_V = 1$, $C_L = 100pF$ $V_{IN} = 8V_{P-P}$, $I_Q = 100\mu A$, $R_L = 100k\Omega$	25	-	0.16	-	-	0.16	-	-	0.16	-	$V/\mu s$
Rise Time	t_R	$V_{IN} = 50mV$, $C_L = 100pF$ $I_Q = 100\mu A$, $R_L = 100k\Omega$	25	-	2	-	-	2	-	-	2	-	μs
Overshoot Factor	OS	$V_{IN} = 50mV$, $C_L = 100pF$ $I_Q = 100\mu A$, $R_L = 100k\Omega$	25	-	10	-	-	10	-	-	10	-	%

Electrical Specifications $V_{SUPPLY} = \pm 5V$, Unless Otherwise Specified

PARAMETER	SYMBOL	TEST CONDITIONS	TEMP. (°C)	ICL7641C, ICL7642C			ICL7641E, ICL7642E			UNITS
				MIN	TYP	MAX	MIN	TYP	MAX	
Input Offset Voltage	V_{OS}	$R_S \leq 100k\Omega$	25	-	-	10	-	-	20	mV
			Full	-	-	15	-	-	25	mV
Temperature Coefficient of V_{OS}	$\Delta V_{OS}/\Delta T$	$R_S \leq 100k\Omega$	-	-	20	-	-	30	-	$\mu V/^\circ C$
Input Offset Current	I_{OS}		25	-	0.5	30	-	0.5	30	pA
			0 to 70	-	-	300	-	-	300	pA
			-55 to 125	-	-	800	-	-	800	pA
Input Bias Current	I_{BIAS}		25	-	1.0	50	-	1.0	50	pA
			0 to 70	-	-	500	-	-	500	pA
			-55 to 125	-	-	4000	-	-	4000	pA
Common Mode Voltage Range	V_{CMR}	$I_Q = 10\mu A$, ICL7642	25	± 4.4	-	-	± 4.4	-	-	V
		$I_Q = 1mA$, ICL7641	25	± 3.7	-	-	± 3.7	-	-	V
Output Voltage Swing	V_{OUT}	ICL7642, $I_Q = 10\mu A$, $R_L = 1M\Omega$	25	± 4.9	-	-	± 4.9	-	-	V
			0 to 70	± 4.8	-	-	± 4.8	-	-	V
			-55 to 125	± 4.7	-	-	± 4.7	-	-	V
		ICL7641, $I_Q = 1mA$, $R_L = 10k\Omega$	25	± 4.5	-	-	± 4.5	-	-	V
			0 to 70	± 4.3	-	-	± 4.3	-	-	V
			-55 to 125	± 4.0	-	-	± 4.0	-	-	V

ICL7621, ICL7641, ICL7642

Electrical Specifications $V_{SUPPLY} = \pm 5V$, Unless Otherwise Specified (Continued)

PARAMETER	SYMBOL	TEST CONDITIONS	TEMP. (°C)	ICL7641C, ICL7642C			ICL7641E, ICL7642E			UNITS
				MIN	TYP	MAX	MIN	TYP	MAX	
Large Signal Voltage Gain	A_{VOL}	ICL7642, $V_O = \pm 4V$, $R_L = 1M\Omega$, $I_Q = 10\mu A$	25	80	104	-	80	104	-	dB
			0 to 70	75	-	-	75	-	-	dB
			-55 to 125	68	-	-	68	-	-	dB
		ICL7641, $V_O = \pm 4V$, $R_L = 10k\Omega$, $I_Q = 1mA$	25	76	98	-	76	98	-	dB
			0 to 70	72	-	-	72	-	-	dB
			-55 to 125	68	-	-	68	-	-	dB
Unity Gain Bandwidth	GBW	ICL7642, $I_Q = 10\mu A$	25	-	0.044	-	-	0.044	-	MHz
		ICL7641, $I_Q = 1mA$	25	-	1.4	-	-	1.4	-	MHz
Input Resistance	R_{IN}		25	-	10^{12}	-	-	10^{12}	-	Ω
Common Mode Rejection Ratio	CMRR	ICL7642, $R_S \leq 100k\Omega$, $I_Q = 10\mu A$	25	70	96	-	70	96	-	dB
		ICL7641, $R_S \leq 100k\Omega$, $I_Q = 1mA$	25	60	87	-	60	87	-	dB
Power Supply Rejection Ratio ($V_{SUPPLY} = \pm 8V$ to $\pm 2V$)	PSRR	ICL7642, $R_S \leq 100k\Omega$, $I_Q = 10\mu A$	25	80	94	-	80	94	-	dB
		ICL7641, $R_S \leq 100k\Omega$, $I_Q = 1mA$	25	70	77	-	70	77	-	dB
Input Referred Noise Voltage	e_N	$R_S = 100\Omega$, $f = 1kHz$	25	-	100	-	-	100	-	nV/\sqrt{Hz}
Input Referred Noise Current	i_N	$R_S = 100\Omega$, $f = 1kHz$	25	-	0.01	-	-	0.01	-	pA/\sqrt{Hz}
Supply Current (Per Amplifier) (No Signal, No Load)	I_{SUPPLY}	ICL7642, $I_Q = 10\mu A$ Low Bias	25	-	0.01	0.03	-	0.01	0.03	mA
		ICL7641, $I_Q = 1mA$ High Bias	25	-	1.0	2.5	-	1.0	2.5	mA
Channel Separation	V_{O1}/V_{O2}	$A_V = 100$	25	-	120	-	-	120	-	dB
Slew Rate ($A_V = 1$, $C_L = 100pF$, $V_{IN} = 8V_{P-P}$)	SR	ICL7642, $I_Q = 10\mu A$, $R_L = 1M\Omega$	25	-	0.016	-	-	0.016	-	$V/\mu s$
		ICL7641, $I_Q = 1mA$, $R_L = 10k\Omega$	25	-	1.6	-	-	1.6	-	$V/\mu s$
Rise Time ($V_{IN} = 50mV$, $C_L = 100pF$)	t_R	ICL7642, $I_Q = 10\mu A$, $R_L = 1M\Omega$	25	-	20	-	-	20	-	μs
		ICL7641, $I_Q = 1mA$, $R_L = 10k\Omega$	25	-	0.9	-	-	0.9	-	μs
Overshoot Factor ($V_{IN} = 50mV$, $C_L = 100pF$)	OS	ICL7642, $I_Q = 10\mu A$, $R_L = 1M\Omega$	25	-	5	-	-	5	-	%
		ICL7641, $I_Q = 1mA$, $R_L = 10k\Omega$	25	-	40	-	-	40	-	%

Electrical Specifications $V_{SUPPLY} = \pm 1V$, $I_Q = 10\mu A$, Unless Otherwise Specified

PARAMETERS	SYMBOL	TEST CONDITIONS	TEMP. (°C)	ICL7642C			UNITS
				MIN	TYP	MAX	
Input Offset Voltage	V_{OS}	$R_S \leq 100k\Omega$	25	-	-	10	mV
			Full	-	-	12	mV
Temperature Coefficient of V_{OS}	$\Delta V_{OS}/\Delta T$	$R_S \leq 100k\Omega$	-	-	20	-	$\mu V/^\circ C$
Input Offset Current	I_{OS}		25	-	0.5	30	pA
			0 to 70	-	-	300	pA
Input Bias Current	I_{BIAS}		25	-	1.0	50	pA
			0 to 70	-	-	500	pA
Common Mode Voltage Range	V_{CMR}		25	± 0.6	-	-	V

ICL7621, ICL7641, ICL7642

Electrical Specifications $V_{SUPPLY} = \pm 1V$, $I_Q = 10\mu A$, Unless Otherwise Specified (Continued)

PARAMETERS	SYMBOL	TEST CONDITIONS	TEMP. (°C)	ICL7642C			UNITS
				MIN	TYP	MAX	
Output Voltage Swing	V_{OUT}	$R_L = 1M\Omega$	25	-	± 0.98	-	V
			0 to 70	-	± 0.96	-	V
Large Signal Voltage Gain	A_{VOL}	$V_O = \pm 0.1V$, $R_L = 1M\Omega$	25	-	90	-	dB
			0 to 70	-	80	-	dB
Unity Gain Bandwidth	GBW		25	-	0.044	-	MHz
Input Resistance	R_{IN}		25	-	10^{12}	-	Ω
Common Mode Rejection Ratio	CMRR	$R_S \leq 100k\Omega$	25	-	80	-	dB
Power Supply Rejection Ratio	PSRR		25	-	80	-	dB
Input Referred Noise Voltage	e_N	$R_S = 100\Omega$, $f = 1kHz$	25	-	100	-	nV/\sqrt{Hz}
Input Referred Noise Current	i_N	$R_S = 100\Omega$, $f = 1kHz$	25	-	0.01	-	pA/\sqrt{Hz}
Supply Current (Per Amplifier)	I_{SUPPLY}	No Signal, No Load	25	-	6	15	μA
Channel Separation	V_{O1}/V_{O2}	$A_V = 100$	25	-	120	-	dB
Slew Rate	SR	$A_V = 1$, $C_L = 100pF$, $V_{IN} = 0.2V_{P-P}$, $R_L = 1M\Omega$	25	-	0.016	-	$V/\mu s$
Rise Time	t_R	$V_{IN} = 50mV$, $C_L = 100pF$, $R_L = 1M\Omega$	25	-	20	-	μs
Overshoot Factor	OS	$V_{IN} = 50mV$, $C_L = 100pF$, $R_L = 1M\Omega$	25	-	5	-	%

Schematic Diagram

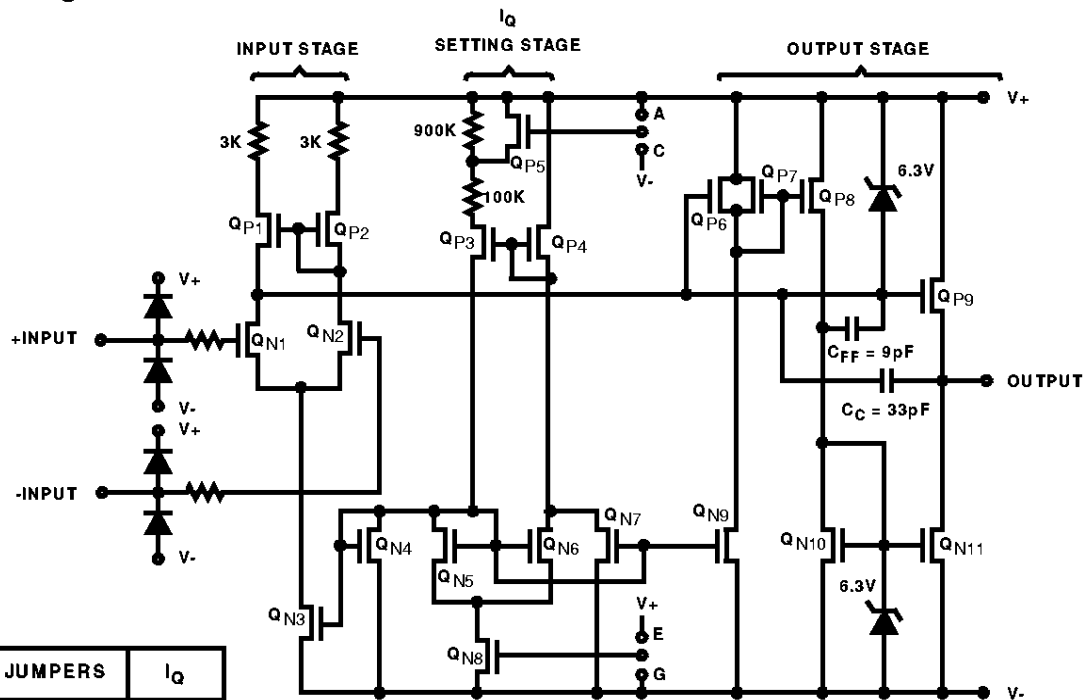

TABLE OF JUMPERS		I_Q
ICL7621	C, E	$100\mu A$
ICL7641	C, G	$1mA$
ICL7642	A, E	$10\mu A$

Application Information

Static Protection

All devices are static protected by the use of input diodes. However, strong static fields should be avoided, as it is possible for the strong fields to cause degraded diode junction characteristics, which may result in increased input leakage currents.

Latchup Avoidance

Junction-isolated CMOS circuits employ configurations which produce a parasitic 4-layer (PNPN) structure. The 4-layer structure has characteristics similar to an SCR, and under certain circumstances may be triggered into a low impedance state resulting in excessive supply current. To avoid this condition, no voltage greater than 0.3V beyond the supply rails may be applied to any pin. In general, the op amp supplies must be established simultaneously with, or before any input signals are applied. If this is not possible, the drive circuits must limit input current flow to 2mA to prevent latchup.

Choosing the Proper I_Q

Each device in the ICL76XX family has a similar I_Q setup scheme, which allows the amplifier to be set to nominal quiescent currents of 10 μ A, 100 μ A or 1mA. These current settings change only very slightly over the entire supply voltage range. The ICL7611/12 have an external I_Q control terminal, permitting user selection of each amplifiers' quiescent current. The ICL7621 and ICL7641/7642 have fixed I_Q settings:

ICL7621 (Dual) - $I_Q = 100\mu\text{A}$

ICL7641 (Quad) - $I_Q = 1\text{mA}$

ICL7642 (Quad) - $I_Q = 10\mu\text{A}$

NOTE: The output current available is a function of the quiescent current setting. For maximum peak-to-peak output voltage swings into low impedance loads, I_Q of 1mA should be selected.

Output Stage and Load Driving Considerations

Each amplifiers' quiescent current flows primarily in the output stage. This is approximately 70% of the I_Q settings. This allows output swings to almost the supply rails for output loads of 1M Ω , 100k Ω , and 10k Ω , using the output stage in a highly linear class A mode. In this mode, crossover distortion is avoided and the voltage gain is maximized. However, the output stage can also be operated in Class AB for higher output currents. (See graphs under Typical Operating Characteristics). During the transition from Class A to Class B operation, the output transfer characteristic is non-linear and the voltage gain decreases.

Frequency Compensation

The ICL76XX are internally compensated, and are stable for closed loop gains as low as unity with capacitive loads up to 100pF.

Operation At $V_{\text{SUPPLY}} = \pm 1\text{V}$

Operation at $V_{\text{SUPPLY}} = \pm 1\text{V}$ is guaranteed for the ICL7642C only.

Output swings to within a few millivolts of the supply rails are achievable for $R_L \geq 1\text{M}\Omega$. Guaranteed input CMVR is $\pm 0.6\text{V}$ minimum and typically +0.9V to -0.7V at $V_{\text{SUPPLY}} = \pm 1\text{V}$. For applications where greater common mode range is desirable, refer to the ICL7612 data sheet.

Typical Applications

The user is cautioned that, due to extremely high input impedances, care must be exercised in layout, construction, board cleanliness, and supply filtering to avoid hum and noise pickup.

Note that in no case is I_Q shown. The value of I_Q must be chosen by the designer with regard to frequency response and power dissipation.

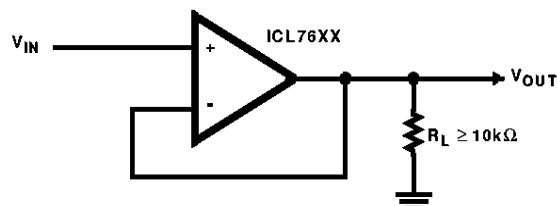

FIGURE 1. SIMPLE FOLLOWER

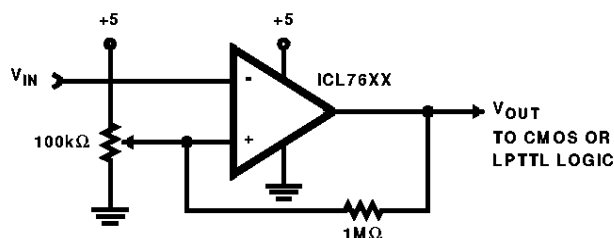
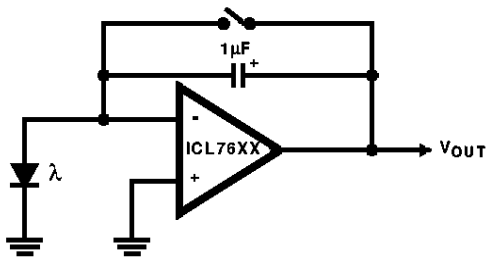
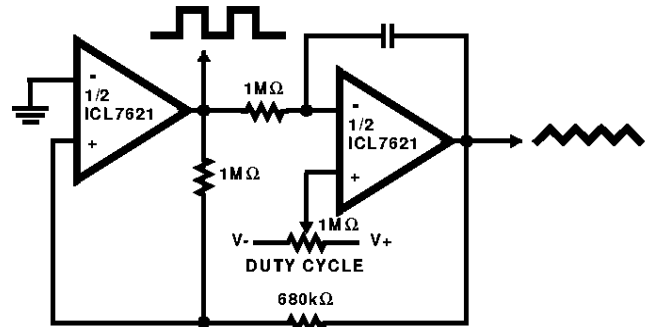

FIGURE 2. LEVEL DETECTOR



NOTE: Low leakage currents allow integration times up to several hours.

FIGURE 3. PHOTOCURRENT INTEGRATOR



NOTE: Since the output range swings exactly from rail to rail, frequency and duty cycle are virtually independent of power supply variations.

FIGURE 4. TRIANGLE/SQUARE WAVE GENERATOR

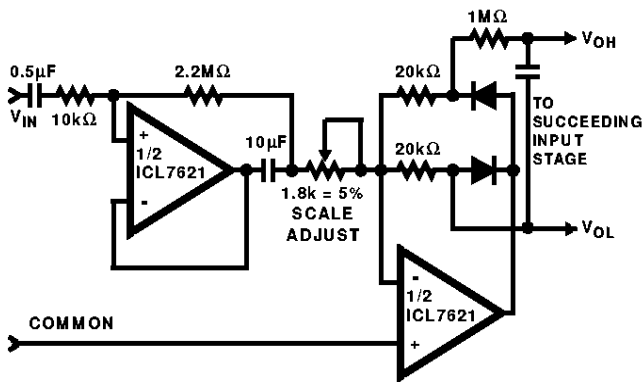

FIGURE 5. AVERAGING AC TO DC CONVERTER FOR A/D CONVERTERS SUCH AS ICL7106, ICL7107, ICL7109, ICL7116, ICL7117

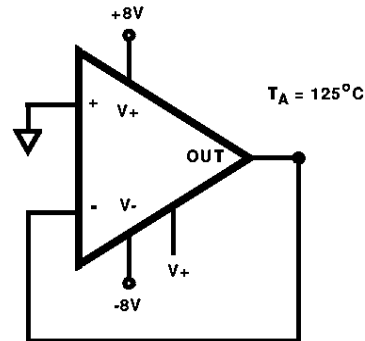
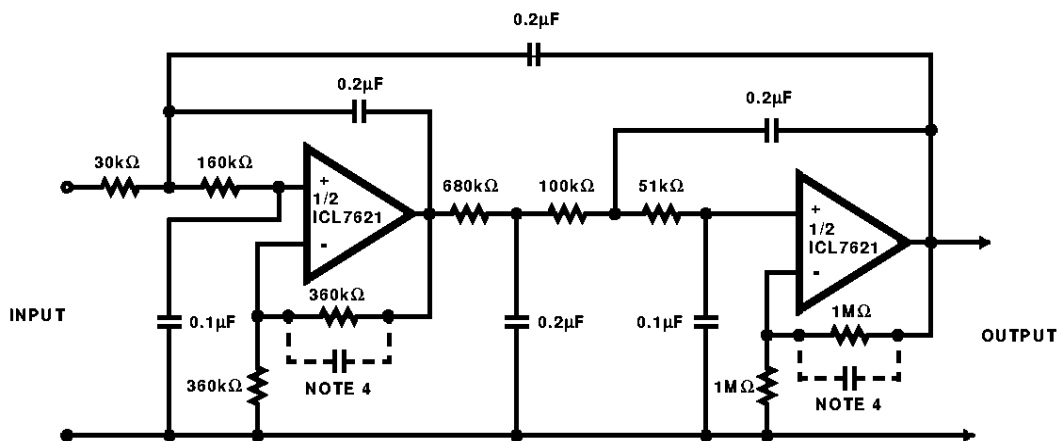

FIGURE 6. BURN-IN AND LIFE TEST CIRCUIT



NOTES:

4. Small capacitors (25 - 50pF) may be needed for stability in some cases.
5. The low bias currents permit high resistance and low capacitance values to be used to achieve low frequency cutoff. $f_C = 10\text{Hz}$, $A_{VCL} = 4$, Passband ripple = 0.1dB.

FIGURE 7. FIFTH ORDER CHEBYCHEV MULTIPLE FEEDBACK LOW PASS FILTER

Typical Performance Curves

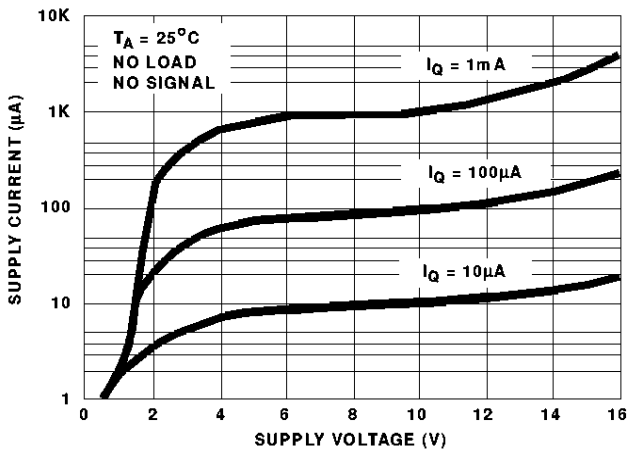

FIGURE 8. SUPPLY CURRENT PER AMPLIFIER vs SUPPLY VOLTAGE

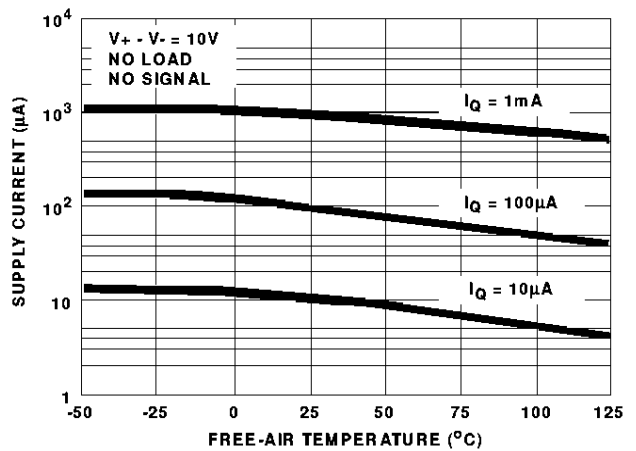

FIGURE 9. SUPPLY CURRENT PER AMPLIFIER vs FREE-AIR TEMPERATURE

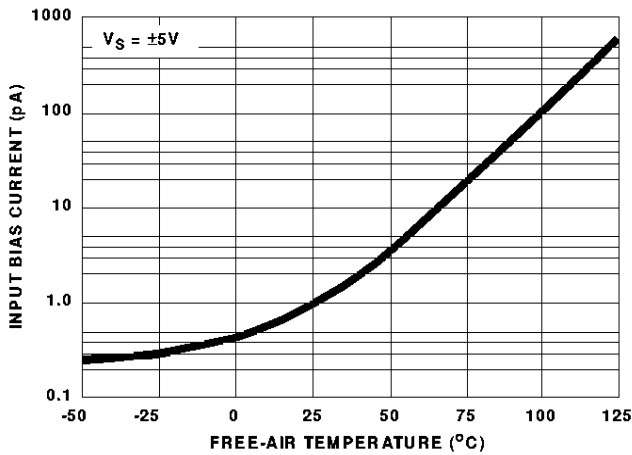

FIGURE 10. INPUT BIAS CURRENT vs TEMPERATURE

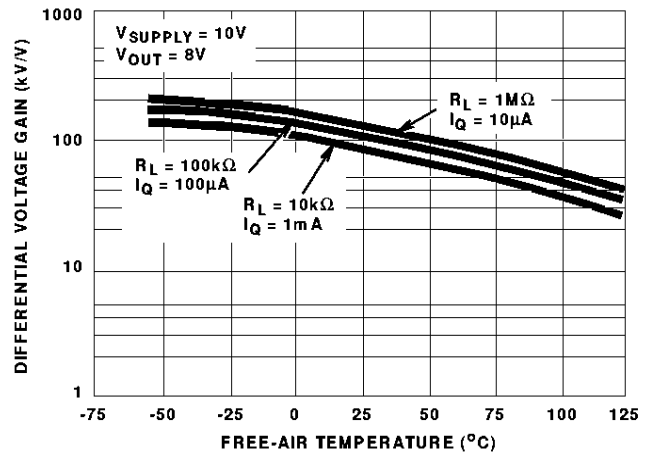

FIGURE 11. LARGE SIGNAL DIFFERENTIAL VOLTAGE GAIN vs FREE-AIR TEMPERATURE

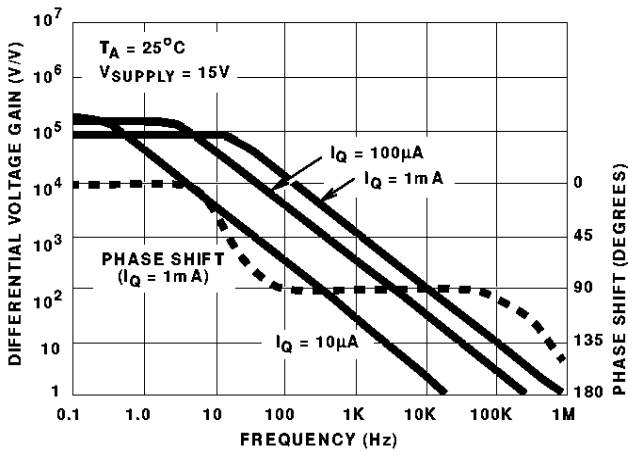

FIGURE 12. LARGE SIGNAL FREQUENCY RESPONSE

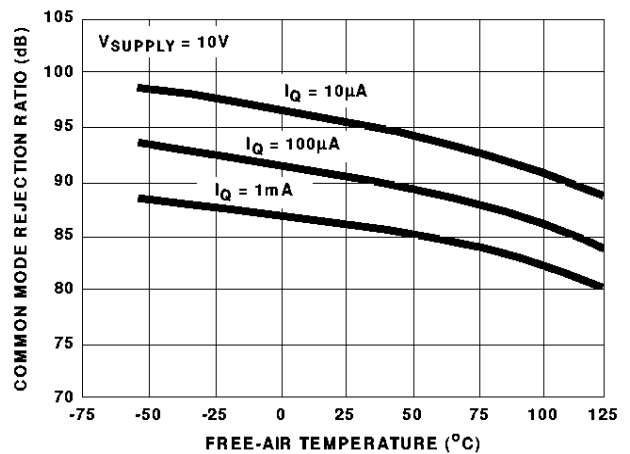

FIGURE 13. COMMON MODE REJECTION RATIO vs FREE-AIR TEMPERATURE

Typical Performance Curves (Continued)

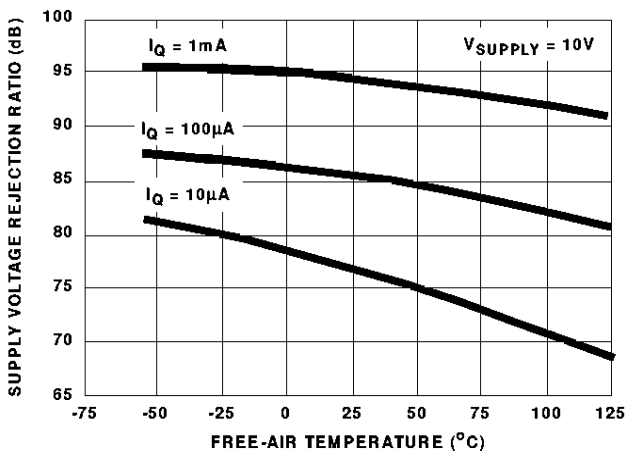

FIGURE 14. POWER SUPPLY REJECTION RATIO vs FREE-AIR TEMPERATURE

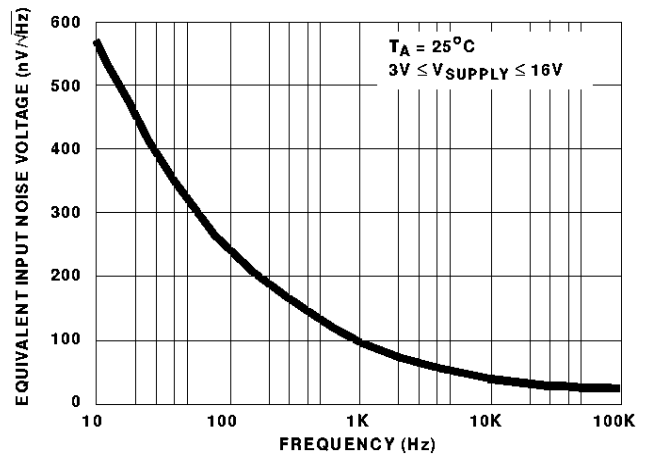

FIGURE 15. EQUIVALENT INPUT NOISE VOLTAGE vs FREQUENCY

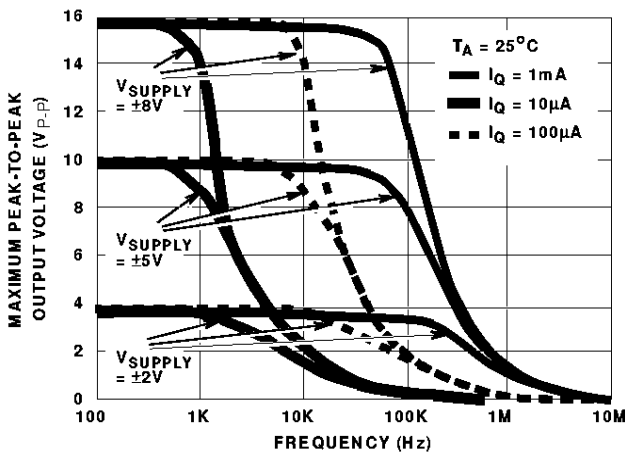

FIGURE 16. OUTPUT VOLTAGE vs FREQUENCY

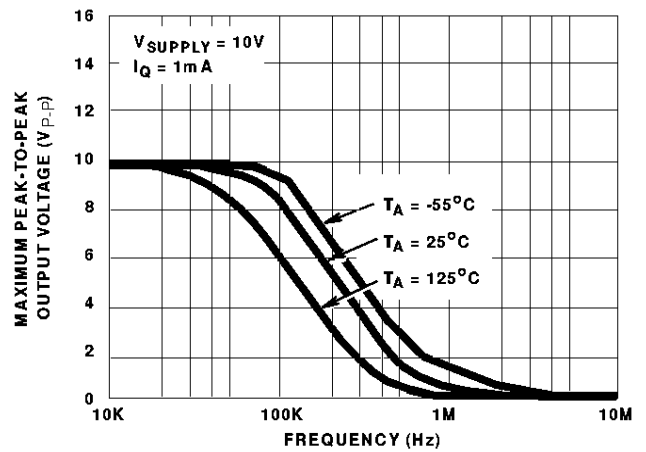

FIGURE 17. OUTPUT VOLTAGE vs FREQUENCY

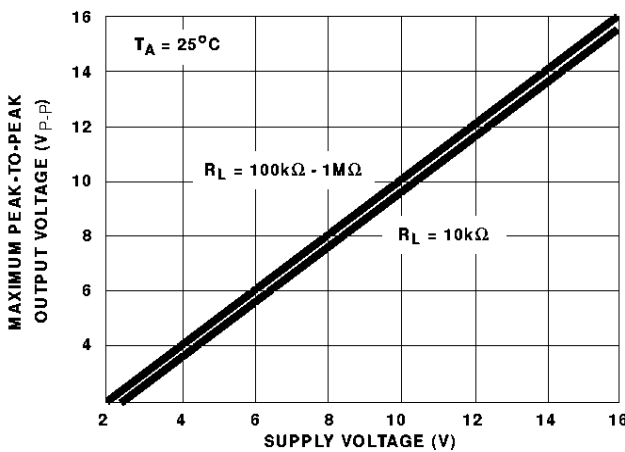

FIGURE 18. OUTPUT VOLTAGE vs SUPPLY VOLTAGE

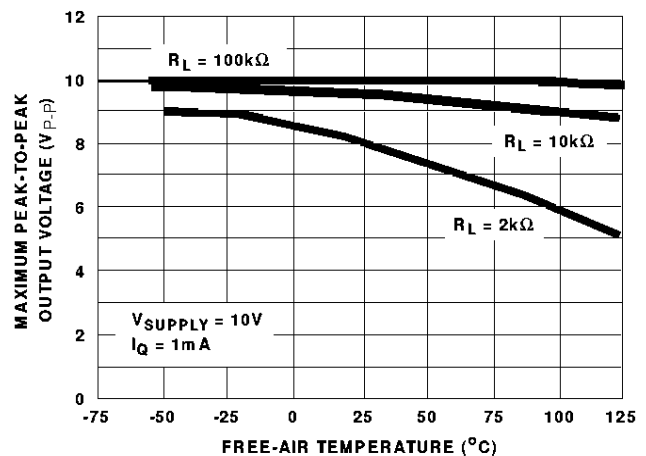

FIGURE 19. OUTPUT VOLTAGE vs FREE-AIR TEMPERATURE

Typical Performance Curves (Continued)

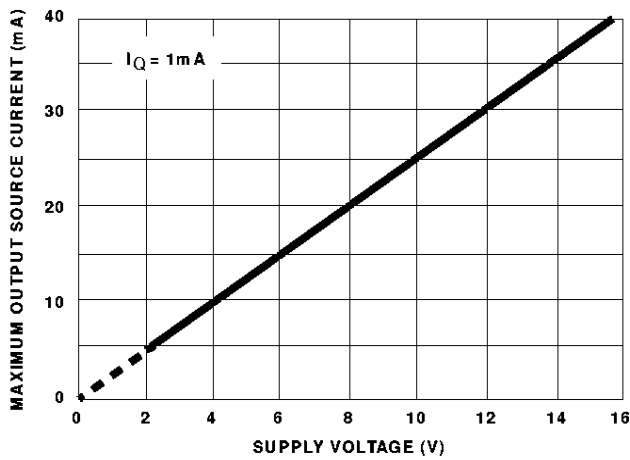

FIGURE 20. OUTPUT SOURCE CURRENT vs SUPPLY VOLTAGE

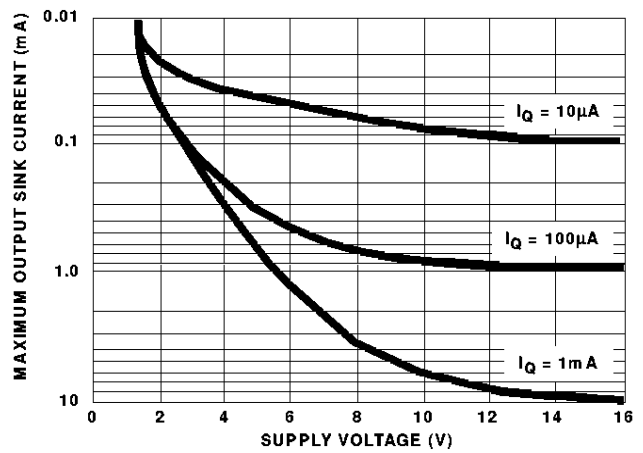

FIGURE 21. OUTPUT SINK CURRENT vs SUPPLY VOLTAGE

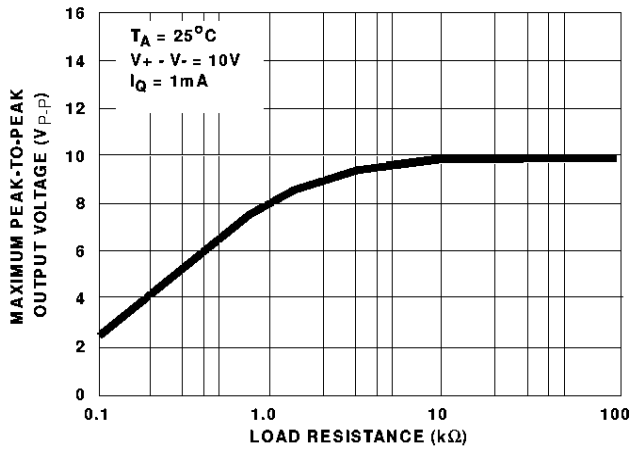

FIGURE 22. OUTPUT VOLTAGE vs LOAD RESISTANCE

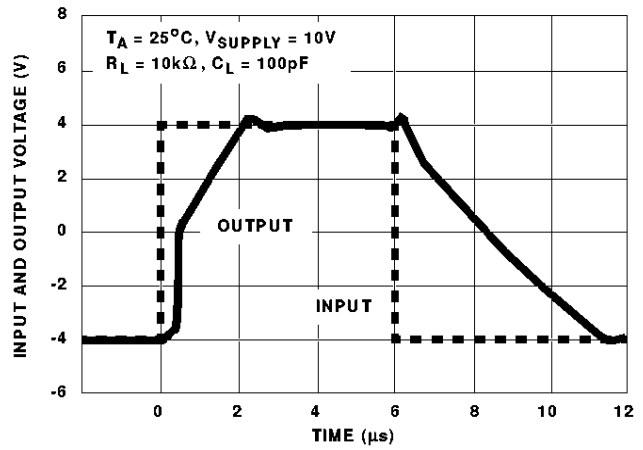

FIGURE 23. VOLTAGE FOLLOWER LARGE SIGNAL PULSE RESPONSE ($I_Q = 1\text{mA}$)

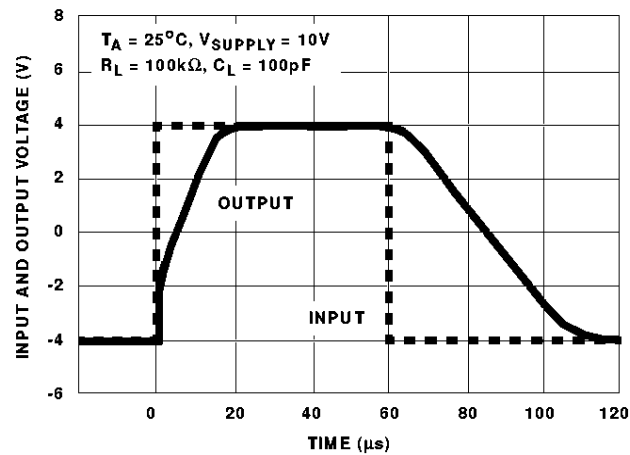

FIGURE 24. VOLTAGE FOLLOWER LARGE SIGNAL PULSE RESPONSE ($I_Q = 100\mu\text{A}$)

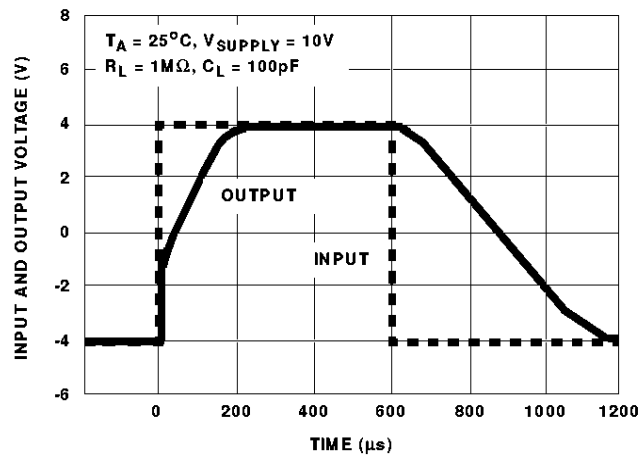

FIGURE 25. VOLTAGE FOLLOWER LARGE SIGNAL PULSE RESPONSE ($I_Q = 10\mu\text{A}$)