

1-104257-7 ✓ ACTIVE

AMPMODU | AMPMODU MTE

TE Internal #: 1-104257-7

Housing, Receptacle, Wire-to-Board, 18 Position, .1 in [2.54 mm]
Centerline, Crimp / Insulation Displacement (IDC), 1 Row, Black,
AMPMODU MTE

[View on TE.com >](#)



Connectors > PCB Connectors > Wire-to-Board Connectors > Wire-to-Board Connector Assemblies & Housings



Connector Product Type: **Housing**

Connector & Housing Type: **Receptacle**

Connector System: **Wire-to-Board**

Number of Positions: **18**

Centerline (Pitch): **2.54 mm [.1 in]**

Features

Product Type Features

Connector Product Type	Housing
Connector & Housing Type	Receptacle
Connector System	Wire-to-Board
Sealable	No
Connector & Contact Terminates To	Wire & Cable

Configuration Features

Number of Positions	18
Number of Rows	1

Electrical Characteristics

Dielectric Withstanding Voltage (Max)	600 VAC
Insulation Resistance	5000 MΩ
Operating Voltage	267 V

Body Features

Primary Product Color	Black
-----------------------	-------

Contact Features

Contact Retention Within Housing	With
Contact Layout	Inline
Contact Type	Socket



Contact Current Rating (Max)	3 A
------------------------------	-----

Termination Features

Termination Method to Wire & Cable	Crimp, Insulation Displacement (IDC)
------------------------------------	--------------------------------------

Mechanical Attachment

Strain Relief	Without
---------------	---------

Contact Retention Type Within Housing	Locking Lance
---------------------------------------	---------------

Panel Mount Feature	Without
---------------------	---------

PCB Mount Retention	Without
---------------------	---------

Mating Retention Type	Latch
-----------------------	-------

Mating Retention	With
------------------	------

Connector Mounting Type	Cable Mount (Free-Hanging)
-------------------------	----------------------------

Housing Features

Housing Material	Thermoplastic
------------------	---------------

Centerline (Pitch)	2.54 mm[.1 in]
--------------------	----------------

Dimensions

Connector Length	45.67 mm[1.798 in]
------------------	--------------------

Connector Height	6.73 mm[.265 in]
------------------	------------------

Usage Conditions

Operating Temperature Range	-65 – 105 °C[-85 – 221 °F]
-----------------------------	----------------------------

Operation/Application

Circuit Application	Signal
---------------------	--------

Industry Standards

Glow Wire Rating	Standard Part - Not Glow Wire
------------------	-------------------------------

UL Flammability Rating	UL 94V-0
------------------------	----------

Packaging Features

Packaging Quantity	500
--------------------	-----

Packaging Method	Bag
------------------	-----

Other

Discrete Wire Connector Comment	Refer to AMPMODU contacts for crimp snap-in replacement receptacle or pin contacts.
---------------------------------	-------------------------------------------------------------------------------------



Product Compliance



[For compliance documentation, visit the product page on TE.com>](#)

EU RoHS Directive 2011/65/EU	Compliant
EU ELV Directive 2000/53/EC	Compliant
China RoHS 2 Directive MIIT Order No 32, 2016	No Restricted Materials Above Threshold
EU REACH Regulation (EC) No. 1907/2006	Current ECHA Candidate List: JUNE 2023 (235) Candidate List Declared Against: JUNE 2022 (224) Does not contain REACH SVHC
Halogen Content	Low Halogen - Br, Cl, F, I < 900 ppm per homogenous material. Also BFR/CFR/PVC Free
Solder Process Capability	Not applicable for solder process capability

Product Compliance Disclaimer

This information is provided based on reasonable inquiry of our suppliers and represents our current actual knowledge based on the information they provided. This information is subject to change. The part numbers that TE has identified as EU RoHS compliant have a maximum concentration of 0.1% by weight in homogenous materials for lead, hexavalent chromium, mercury, PBB, PBDE, DBP, BBP, DEHP, DIBP, and 0.01% for cadmium, or qualify for an exemption to these limits as defined in the Annexes of Directive 2011/65/EU (RoHS2). Finished electrical and electronic equipment products will be CE marked as required by Directive 2011/65/EU. Components may not be CE marked. Additionally, the part numbers that TE has identified as EU ELV compliant have a maximum concentration of 0.1% by weight in homogenous materials for lead, hexavalent chromium, and mercury, and 0.01% for cadmium, or qualify for an exemption to these limits as defined in the Annexes of Directive 2000/53/EC (ELV). Regarding the REACH Regulation, the information TE provides on SVHC in articles for this part number is based on the latest European Chemicals Agency (ECHA) 'Guidance on requirements for substances in articles' posted at this URL: <https://echa.europa.eu/guidance-documents/guidance-on-reach>

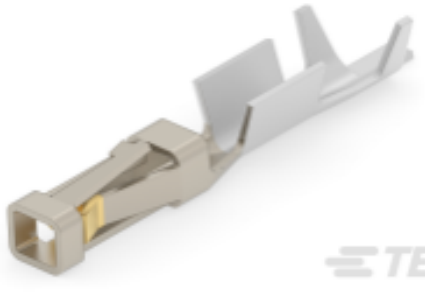
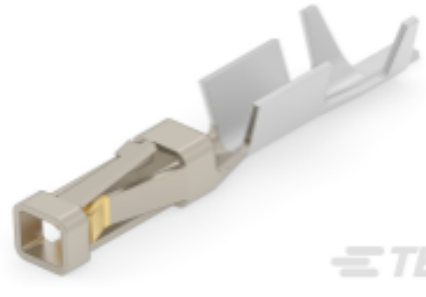
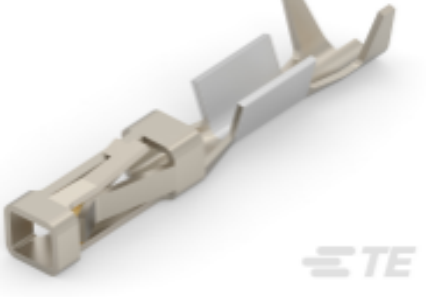
Compatible Parts

 <p>TE Part # 1-104479-0 SHORT POINT CONT 30 DPLX STMPD LF</p>	 <p>TE Part # 104479-9 SHORT POINT CONT 15 DPLX STMPD LF</p>	 <p>TE Part # 1-104480-3 SHORT POINT CONT 30 DPLX STMPD LF</p>	 <p>TE Part # 104479-8 SHORT POINT CONT PLTD SN</p>
-----------------------------------------------------------------------------------------------------------------------------------------------------------	---------------------------------------------------------------------------------------------------------------------------------------------------------	-------------------------------------------------------------------------------------------------------------------------------------------------------------	----------------------------------------------------------------------------------------------------------------------------------------------



TE Part # 1-104480-2
SHORT POINT CONT 15 DPLX
STMPD LF



TE Part # 1-104481-1
SHORT POINT CONT 30 DPLX
STMPD LF



TE Part # 1-104481-0
SHORT POINT CONT 15 DPLX
STMPD LF



TE Part # 1-103653-7
18 MTE SHRD PIN HSG SR LATCH

Also in the Series | AMPMODU MTE



Connector Caps & Covers(40)



Connector Hardware(1)

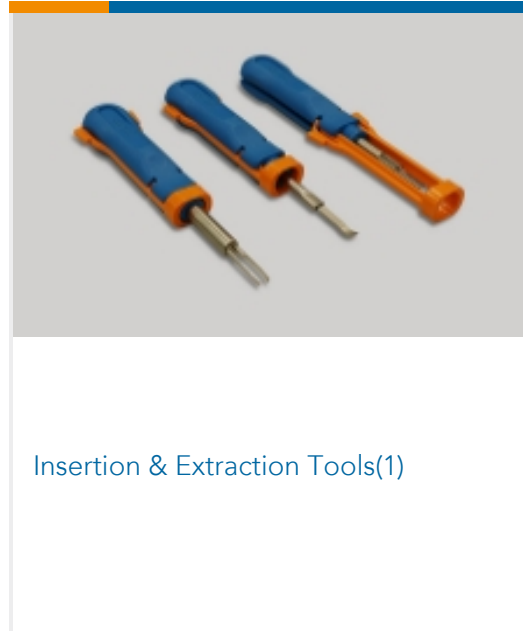

Insertion & Extraction Tools(1)



PCB Headers & Receptacles(763)

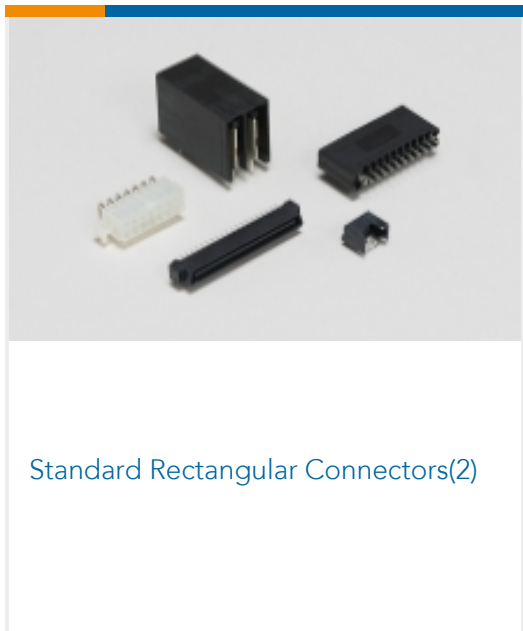

Standard Rectangular Connectors(2)

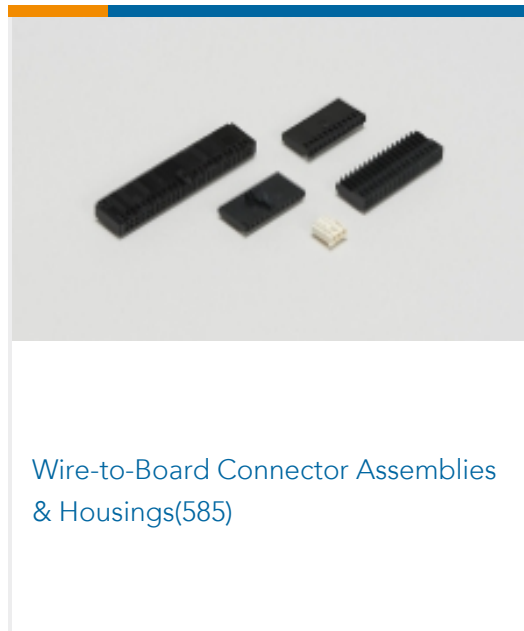

Wire-to-Board Connector Assemblies
& Housings(585)

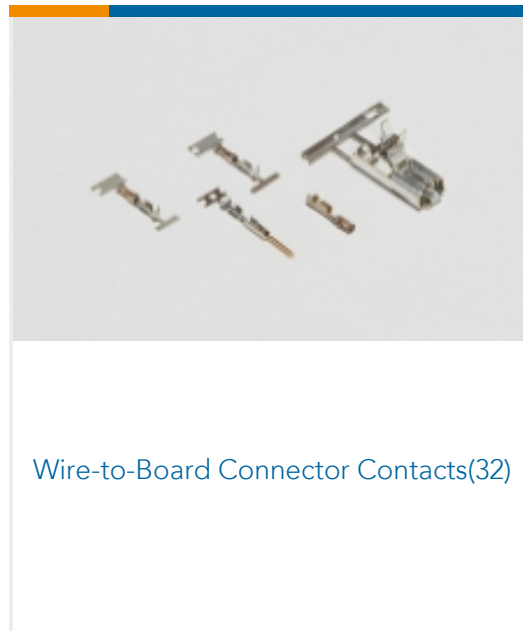

Wire-to-Board Connector Contacts(32)

Customers Also Bought



TE Part #1-111196-9
30 RCPT SYSTEM 50, LEAD FREE



TE Part #1658620-1
10 NOVO MIL 15DP, LEAD FREE



TE Part #160927-4
FF 250 REC 1.0-2.5MM2 TPPB



TE Part #3-520140-2
ULTRA-FAST 250 ASY REC 16-14 AWG
TPBR



TE Part #2-34147-1
PG R 22-16 COMM 22-18 MIL 6



TE Part #1062-20-0222
SOC, SF, SIZE 20, 16-22, NI/NI

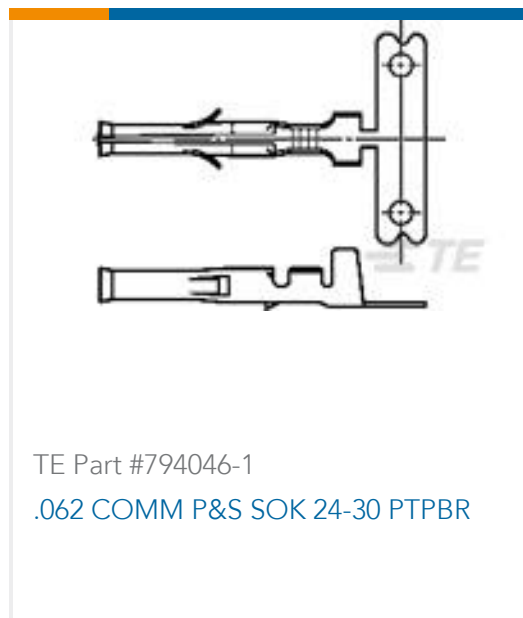

TE Part #794046-1
.062 COMM P&S SOK 24-30 PTPBR



TE Part #1-480701-1
03P UMNL CAP HSG BRN



Documents

Product Drawings

[18 MTE RCPT HSG SR LATCH .100](#)

English

CAD Files

[3D PDF](#)

3D

Customer View Model

[ENG_CVM_CVM_1-104257-7_AH.2d_dxf.zip](#)

English

Customer View Model

[ENG_CVM_CVM_1-104257-7_AH.3d_igs.zip](#)

English

Customer View Model

[ENG_CVM_CVM_1-104257-7_AH.3d_stp.zip](#)

English

By downloading the CAD file I accept and agree to the [Terms and Conditions](#) of use.

Datasheets & Catalog Pages

[AMP MODU MTE Section of Catalog 1307819](#)

English

[AMPMODU_INTERCONNECTION_SYSTEM_SECTION5_CONT](#)

English

[AMPMODU MTE INTERCONNECT SYSTEM](#)

English

Product Specifications

[Application Specification](#)

English

Product Environmental Compliance

[TE Material Declaration](#)

English