

**1.5A LOW DROPOUT LINEAR REGULATOR****AZ1086****General Description**

The AZ1086 is a series of low dropout positive voltage regulators with a maximum dropout of 1.5V at 1.5A of load current.

The series features on-chip thermal shutdown. It also includes a bandgap reference and a current limiting circuit.

The AZ1086 is available in 1.5V, 1.8V, 2.5V, 3.0V, 3.3V, and 5.0V versions. The fixed versions integrate the adjust resistors. It is also available in an adjustable version, which can set the output voltage with only two external resistors.

The AZ1086 series is available in standard packages of TO-263-3, TO-220-3, SOT-223 and TO-252-2 (1).

**Features**

- Low Dropout Voltage: Typical 1.3V at 1.5A
- Current Limiting and Thermal Protection
- Output Current: 1.5A
- Current Limit: 2.3A
- Operating Junction Temperature: 0 to 125°C
- Line Regulation: 0.015% (Typical)
- Load Regulation: 0.1% (Typical)

**Applications**

- High Efficiency Linear Regulators
- Battery Charger
- Post Regulation for Switching Supply
- Microprocessor Supply
- Motherboard Power Supply
- Cable and ADSL Modem
- DVD-Video Player
- Telecom Equipment
- Set Top Boxes and Web Boxes Modules' Supply

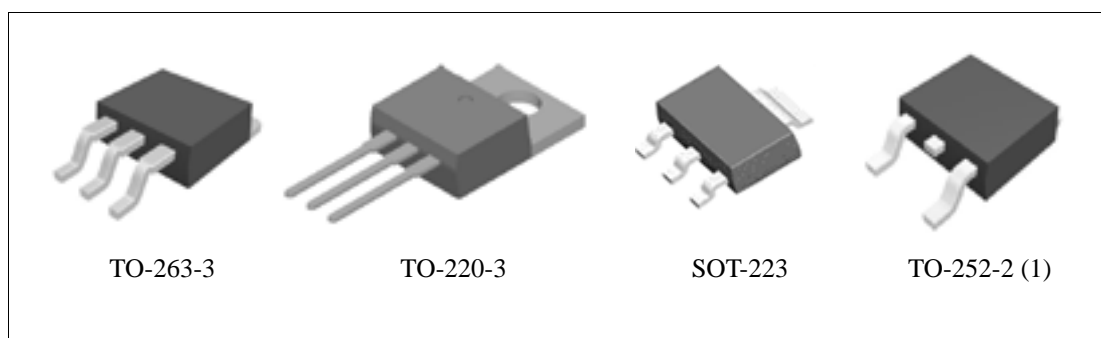

Figure 1. Package Types of AZ1086



# 1.5A LOW DROPOUT LINEAR REGULATOR

# AZ1086

## Pin Configuration

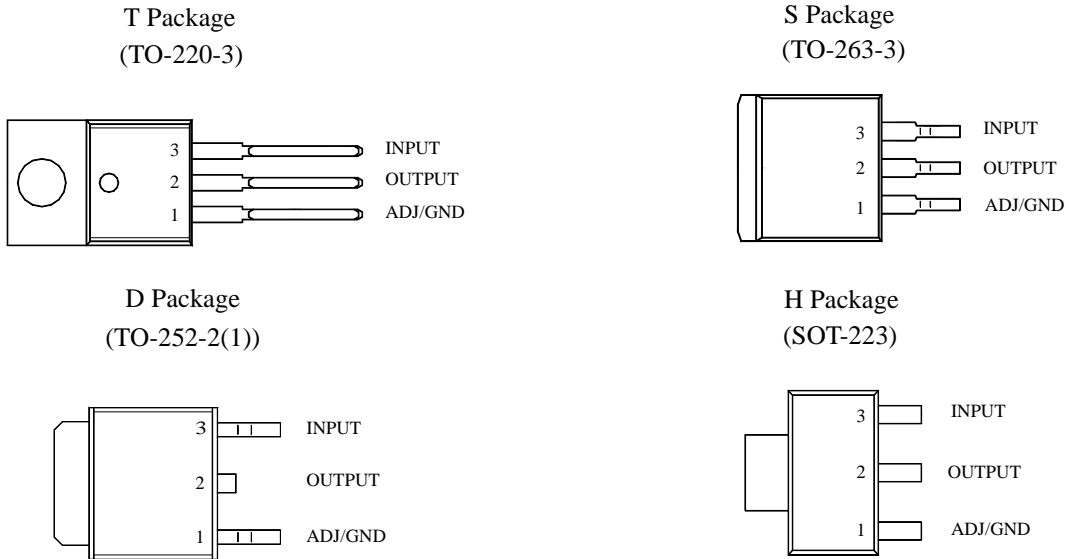

Figure 2. Pin Configuration of AZ1086 (Top View)

## Functional Block Diagram

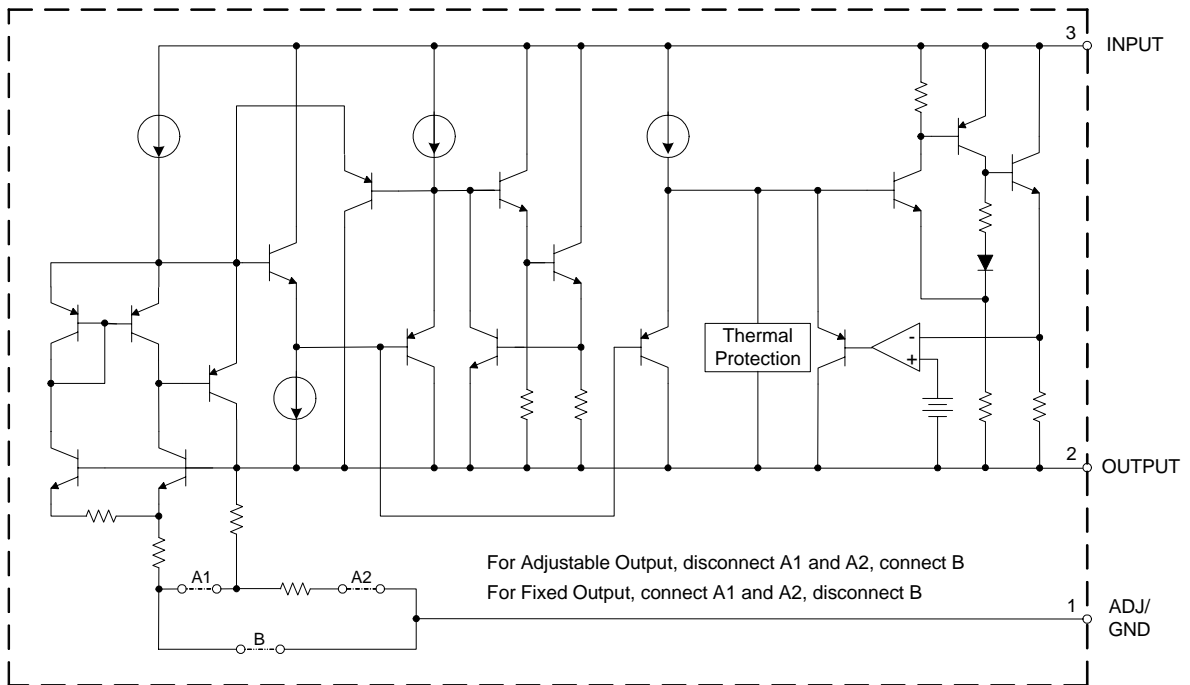

Figure 3. Functional Block Diagram of AZ1086



**1.5A LOW DROPOUT LINEAR REGULATOR**

**AZ1086**

**Ordering Information**

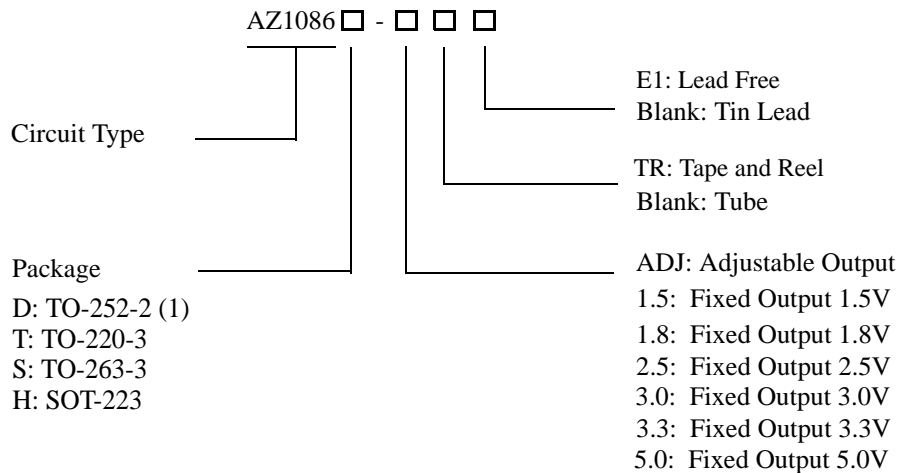

Package	Temperature Range	Part Number		Marking ID		Packing Type
		Tin Lead	Lead Free	Tin Lead	Lead Free	
TO-252-2 (1)	0 to 125°C	AZ1086D-ADJ	AZ1086D-ADJE1	AZ1086D-ADJ	AZ1086D-ADJE1	Tube
		AZ1086D-ADJTR	AZ1086D-ADJTRE1	AZ1086D-ADJ	AZ1086D-ADJE1	Tape & Reel
		AZ1086D-1.5	AZ1086D-1.5E1	AZ1086D-1.5	AZ1086D-1.5E1	Tube
		AZ1086D-1.5TR	AZ1086D-1.5TRE1	AZ1086D-1.5	AZ1086D-1.5E1	Tape & Reel
		AZ1086D-1.8	AZ1086D-1.8E1	AZ1086D-1.8	AZ1086D-1.8E1	Tube
		AZ1086D-1.8TR	AZ1086D-1.8TRE1	AZ1086D-1.8	AZ1086D-1.8E1	Tape & Reel
		AZ1086D-2.5	AZ1086D-2.5E1	AZ1086D-2.5	AZ1086D-2.5E1	Tube
		AZ1086D-2.5TR	AZ1086D-2.5TRE1	AZ1086D-2.5	AZ1086D-2.5E1	Tape & Reel
		AZ1086D-3.0	AZ1086D-3.0E1	AZ1086D-3.0	AZ1086D-3.0E1	Tube
		AZ1086D-3.0TR	AZ1086D-3.0TRE1	AZ1086D-3.0	AZ1086D-3.0E1	Tape & Reel
		AZ1086D-3.3	AZ1086D-3.3E1	AZ1086D-3.3	AZ1086D-3.3E1	Tube
		AZ1086D-3.3TR	AZ1086D-3.3TRE1	AZ1086D-3.3	AZ1086D-3.3E1	Tape & Reel
		AZ1086D-5.0	AZ1086D-5.0E1	AZ1086D-5.0	AZ1086D-5.0E1	Tube
		AZ1086D-5.0TR	AZ1086D-5.0TRE1	AZ1086D-5.0	AZ1086D-5.0E1	Tape & Reel
TO-220-3	0 to 125°C	AZ1086T-ADJ	AZ1086T-ADJE1	AZ1086T-ADJ	AZ1086T-ADJE1	Tube
		AZ1086T-1.5	AZ1086T-1.5E1	AZ1086T-1.5	AZ1086T-1.5E1	Tube
		AZ1086T-1.8	AZ1086T-1.8E1	AZ1086T-1.8	AZ1086T-1.8E1	Tube
		AZ1086T-2.5	AZ1086T-2.5E1	AZ1086T-2.5	AZ1086T-2.5E1	Tube
		AZ1086T-3.0	AZ1086T-3.0E1	AZ1086T-3.0	AZ1086T-3.0E1	Tube
		AZ1086T-3.3	AZ1086T-3.3E1	AZ1086T-3.3	AZ1086T-3.3E1	Tube
		AZ1086T-5.0	AZ1086T-5.0E1	AZ1086T-5.0	AZ1086T-5.0E1	Tube

**1.5A LOW DROPOUT LINEAR REGULATOR****AZ1086****Ordering Information (Continued)**

Package	Temperature Range	Part Number		Marking ID		Packing Type
		Tin Lead	Lead Free	Tin Lead	Lead Free	
TO-263-3	0 to 125°C	AZ1086S-ADJ	AZ1086S-ADJE1	AZ1086S-ADJ	AZ1086S-ADJE1	Tube
		AZ1086S-ADJTR	AZ1086S-ADJTRE1	AZ1086S-ADJ	AZ1086S-ADJE1	Tape & Reel
		AZ1086S-1.5	AZ1086S-1.5E1	AZ1086S-1.5	AZ1086S-1.5E1	Tube
		AZ1086S-1.5TR	AZ1086S-1.5TRE1	AZ1086S-1.5	AZ1086S-1.5E1	Tape & Reel
		AZ1086S-1.8	AZ1086S-1.8E1	AZ1086S-1.8	AZ1086S-1.8E1	Tube
		AZ1086S-1.8TR	AZ1086S-1.8TRE1	AZ1086S-1.8	AZ1086S-1.8E1	Tape & Reel
		AZ1086S-2.5	AZ1086S-2.5E1	AZ1086S-2.5	AZ1086S-2.5E1	Tube
		AZ1086S-2.5TR	AZ1086S-2.5TRE1	AZ1086S-2.5	AZ1086S-2.5E1	Tape & Reel
		AZ1086S-3.0	AZ1086S-3.0E1	AZ1086S-3.0	AZ1086S-3.0E1	Tube
		AZ1086S-3.0TR	AZ1086S-3.0TRE1	AZ1086S-3.0	AZ1086S-3.0E1	Tape & Reel
		AZ1086S-3.3	AZ1086S-3.3E1	AZ1086S-3.3	AZ1086S-3.3E1	Tube
		AZ1086S-3.3TR	AZ1086S-3.3TRE1	AZ1086S-3.3	AZ1086S-3.3E1	Tape & Reel
		AZ1086S-5.0	AZ1086S-5.0E1	AZ1086S-5.0	AZ1086S-5.0E1	Tube
		AZ1086S-5.0TR	AZ1086S-5.0TRE1	AZ1086S-5.0	AZ1086S-5.0E1	Tape & Reel
SOT-223	0 to 125°C	AZ1086H-ADJTR	AZ1086H-ADJTRE1	H86A	EH86A	Tape & Reel
		AZ1086H-1.5TR	AZ1086H-1.5TRE1	H86B	EH86B	Tape & Reel
		AZ1086H-1.8TR	AZ1086H-1.8TRE1	H86E	EH86E	Tape & Reel
		AZ1086H-2.5TR	AZ1086H-2.5TRE1	H86C	EH86C	Tape & Reel
		AZ1086H-3.0TR	AZ1086H-3.0TRE1	H86G	EH86G	Tape & Reel
		AZ1086H-3.3TR	AZ1086H-3.3TRE1	H86D	EH86D	Tape & Reel
		AZ1086H-5.0TR	AZ1086H-5.0TRE1	H86F	EH86F	Tape & Reel

BCD Semiconductor's Pb-free products, as designated with "E1" suffix in the part number, are RoHS compliant.

**1.5A LOW DROPOUT LINEAR REGULATOR****AZ1086****Absolute Maximum Ratings (Note 1)**

Parameter	Symbol	Value		Unit
Operating Junction Temperature	$T_J$	150		°C
Storage Temperature Range	$T_{STG}$	-65 to 150		°C
Lead Temperature (Soldering, 10sec)	$T_{LEAD}$	260		°C
Thermal Resistance (Note 2)	$\theta_{JA}$	TO-252-2 (1)	100	°C/W
		TO-263-3	60	
		TO-220-3	60	
		SOT-223	120	
ESD (Machine Model)	ESD	400		V

Note 1: Stresses greater than those listed under "Absolute Maximum Ratings" may cause permanent damage to the device. These are stress ratings only, and functional operation of the device at these or any other conditions beyond those indicated under "Recommended Operating Conditions" is not implied. Exposure to "Absolute Maximum Ratings" for extended periods may affect device reliability.

Note 2: Absolute maximum ratings indicate limits beyond which damage to the component may occur. Electrical specifications do not apply when operating the device outside of its operating ratings. The maximum allowable power dissipation is a function of the maximum junction temperature,  $T_{J(max)}$ , the junction-to-ambient thermal resistance,  $\theta_{JA}$ , and the ambient temperature,  $T_A$ . The maximum allowable power dissipation at any ambient temperature is calculated using:  $P_{D(max)} = (T_{J(max)} - T_A) / \theta_{JA}$ . Exceeding the maximum allowable power dissipation will result in excessive die temperature, and the regulator will go into thermal shutdown.

**Recommended Operating Conditions**

Parameter	Symbol	Min	Max	Unit
Input Voltage	$V_{IN}$		15	V
Operating Junction Temperature Range	$T_J$	0	125	°C



**1.5A LOW DROPOUT LINEAR REGULATOR**

**AZ1086**

**Electrical Characteristics**

Typicals and limits appearing in normal type apply for  $T_J = 25^\circ\text{C}$ . Limits appearing in **Boldface** type apply over the entire junction temperature range for operation,  $0^\circ\text{C}$  to  $125^\circ\text{C}$ . ( $P_D \leq$  maximum power dissipation, see Note 3.)

Parameter	Symbol	Conditions	Min	Typ	Max	Unit
Reference Voltage	$V_{REF}$	AZ1086-ADJ, $I_{OUT}=10\text{mA}$ , $V_{IN}-V_{OUT}=2\text{V}$ , $T_J=25^\circ\text{C}$ , $10\text{mA} \leq I_{OUT} \leq 1.5\text{A}$ , $1.4\text{V} \leq V_{IN}-V_{OUT} \leq 6\text{V}$	1.238 <b>1.225</b>	1.250 <b>1.250</b>	1.262 <b>1.270</b>	V
Output Voltage	$V_{OUT}$	AZ1086-1.5, $I_{OUT}=10\text{mA}$ , $V_{IN}=3.5\text{V}$ , $T_J=25^\circ\text{C}$ , $10\text{mA} \leq I_{OUT} \leq 1.5\text{A}$ , $3\text{V} \leq V_{IN} \leq 10\text{V}$	1.485 <b>1.47</b>	1.5 <b>1.5</b>	1.515 <b>1.53</b>	V
		AZ1086-1.8, $I_{OUT}=10\text{mA}$ , $V_{IN}=3.8\text{V}$ , $T_J=25^\circ\text{C}$ , $10\text{mA} \leq I_{OUT} \leq 1.5\text{A}$ , $3.2\text{V} \leq V_{IN} \leq 10\text{V}$	1.782 <b>1.746</b>	1.8 <b>1.8</b>	1.818 <b>1.854</b>	V
		AZ1086-2.5, $I_{OUT}=10\text{mA}$ , $V_{IN}=4.5\text{V}$ , $T_J=25^\circ\text{C}$ , $10\text{mA} \leq I_{OUT} \leq 1.5\text{A}$ , $3.9\text{V} \leq V_{IN} \leq 10\text{V}$	2.475 <b>2.45</b>	2.5 <b>2.5</b>	2.525 <b>2.55</b>	V
		AZ1086-3.0, $I_{OUT}=10\text{mA}$ , $V_{IN}=4.5\text{V}$ , $T_J=25^\circ\text{C}$ , $10\text{mA} \leq I_{OUT} \leq 1.5\text{A}$ , $4.9\text{V} \leq V_{IN} \leq 10\text{V}$	2.97 <b>2.94</b>	3.0 <b>3.0</b>	3.03 <b>3.06</b>	V
		AZ1086-3.3, $I_{OUT}=10\text{mA}$ , $V_{IN}=5\text{V}$ , $T_J=25^\circ\text{C}$ , $10\text{mA} \leq I_{OUT} \leq 1.5\text{A}$ , $4.75\text{V} \leq V_{IN} \leq 10\text{V}$	3.267 <b>3.235</b>	3.3 <b>3.3</b>	3.333 <b>3.365</b>	V
		AZ1086-5.0, $I_{OUT}=10\text{mA}$ , $V_{IN}=7\text{V}$ , $T_J=25^\circ\text{C}$ , $10\text{mA} \leq I_{OUT} \leq 1.5\text{A}$ , $6.5\text{V} \leq V_{IN} \leq 10\text{V}$	4.95 <b>4.9</b>	5 <b>5</b>	5.05 <b>5.1</b>	V
Line Regulation	$\Delta V_{OUT}$	AZ1086-ADJ, $I_{OUT} = 10\text{mA}$ , $1.5\text{V} \leq V_{IN}-V_{OUT} \leq 10\text{V}$		0.015 <b>0.035</b>	0.2 <b>0.2</b>	%
		AZ1086-1.5, $I_{OUT}=10\text{mA}$ , $1.5\text{V} \leq V_{IN}-V_{OUT} \leq 10\text{V}$		0.3 <b>0.6</b>	6 <b>6</b>	mV
		AZ1086-1.8, $I_{OUT}=10\text{mA}$ , $1.5\text{V} \leq V_{IN}-V_{OUT} \leq 10\text{V}$		0.3 <b>0.6</b>	6 <b>6</b>	mV
		AZ1086-2.5, $I_{OUT}=10\text{mA}$ , $1.5\text{V} \leq V_{IN}-V_{OUT} \leq 10\text{V}$		0.3 <b>0.6</b>	6 <b>6</b>	mV
		AZ1086-3.0, $I_{OUT}=10\text{mA}$ , $1.5\text{V} \leq V_{IN}-V_{OUT} \leq 10\text{V}$		0.3 <b>0.6</b>	6 <b>6</b>	mV
		AZ1086-3.3, $I_{OUT}=10\text{mA}$ , $1.5\text{V} \leq V_{IN}-V_{OUT} \leq 10\text{V}$		0.5 <b>1</b>	10 <b>10</b>	mV
		AZ1086-5.0, $I_{OUT}=10\text{mA}$ , $1.5\text{V} \leq V_{IN}-V_{OUT} \leq 10\text{V}$		0.5 <b>1</b>	10 <b>10</b>	mV



**1.5A LOW DROPOUT LINEAR REGULATOR**

**AZ1086**

**Electrical Characteristics (Continued)**

Typicals and limits appearing in normal type apply for  $T_J=25^{\circ}\text{C}$ . Limits appearing in **Boldface** type apply over the entire junction temperature range for operation,  $0^{\circ}\text{C}$  to  $125^{\circ}\text{C}$ . ( $P_D \leq$  maximum power dissipation, see Note 3.)

Parameter	Symbol	Conditions	Min	Typ	Max	Unit
Load Regulation	$\Delta V_{OUT}$	AZ1086-ADJ, $10\text{mA} \leq I_{OUT} \leq 1.5\text{A}$ , $V_{IN} - V_{OUT} = 2\text{V}$		0.1 <b>0.2</b>	0.3 <b>0.4</b>	%
		AZ1086-1.5, $10\text{mA} \leq I_{OUT} \leq 1.5\text{A}$ , $V_{IN} - V_{OUT} = 2\text{V}$		3 <b>6</b>	12 <b>20</b>	mV
		AZ1086-1.8, $10\text{mA} \leq I_{OUT} \leq 1.5\text{A}$ , $V_{IN} - V_{OUT} = 2\text{V}$		3 <b>6</b>	12 <b>20</b>	mV
		AZ1086-2.5, $10\text{mA} \leq I_{OUT} \leq 1.5\text{A}$ , $V_{IN} - V_{OUT} = 2\text{V}$		3 <b>6</b>	12 <b>20</b>	mV
		AZ1086-3.0, $10\text{mA} \leq I_{OUT} \leq 1.5\text{A}$ , $V_{IN} - V_{OUT} = 2\text{V}$		3 <b>7</b>	15 <b>20</b>	mV
		AZ1086-3.3, $10\text{mA} \leq I_{OUT} \leq 1.5\text{A}$ , $V_{IN} - V_{OUT} = 2\text{V}$		3 <b>7</b>	15 <b>20</b>	mV
		AZ1086-5.0, $10\text{mA} \leq I_{OUT} \leq 1.5\text{A}$ , $V_{IN} - V_{OUT} = 2\text{V}$		5 <b>10</b>	20 <b>35</b>	mV
Dropout Voltage	$V_{DROP}$	$I_{OUT} = 1.5\text{A}$ , $\Delta V_{REF} = 1\%$		1.3	1.5	V
Current Limit	$I_{LIMIT}$	$V_{IN} - V_{OUT} = 2\text{V}$	1.5	2.3		A
Minimum Load Current	$I_{LOAD(MIN)}$	$1.4\text{V} \leq V_{IN} - V_{OUT} \leq 10\text{V}$ (For ADJ)		<b>2</b>	<b>5</b>	mA
Quiescent Current	$I_Q$	$V_{IN} = V_{OUT} + 1.3\text{V}$		<b>5</b>	<b>10</b>	mA
Ripple Rejection	PSRR	$f_{RIPPLE} = 120\text{Hz}$ , $C_{OUT} = 25\mu\text{F}$ Tantalum, $I_{OUT} = 1.5\text{A}$ , $V_{IN} - V_{OUT} = 3\text{V}$	<b>60</b>	<b>75</b>		dB
Adjust Pin Current	$I_{ADJ}$			60	<b>120</b>	$\mu\text{A}$
Adjust Pin Current Change	$\Delta I_{ADJ}$	$10\text{mA} \leq I_{OUT} \leq 1.5\text{A}$ , $1.4\text{V} \leq V_{IN} - V_{OUT} \leq 10\text{V}$		<b>0.2</b>	<b>5</b>	$\mu\text{A}$
Temperature Stability				<b>0.5</b>		%
RMS Noise (% of $V_{OUT}$ )		$T_A = 25^{\circ}\text{C}$ , $10\text{Hz} \leq f \leq 10\text{kHz}$		0.003		%
Thermal Shutdown		Junction Temperature		165		$^{\circ}\text{C}$
Thermal Shutdown Hysteresis				30		$^{\circ}\text{C}$

Note 3: Maximum power dissipation see Figure 5.



**1.5A LOW DROPOUT LINEAR REGULATOR**

**AZ1086**

**Typical Performance Characteristics**

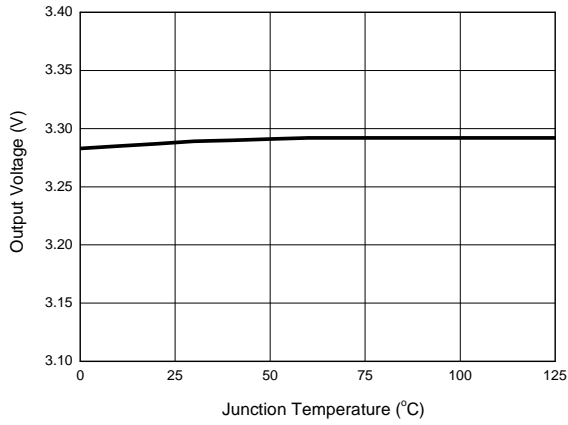

Figure 4. Output Voltage vs. Junction Temperature

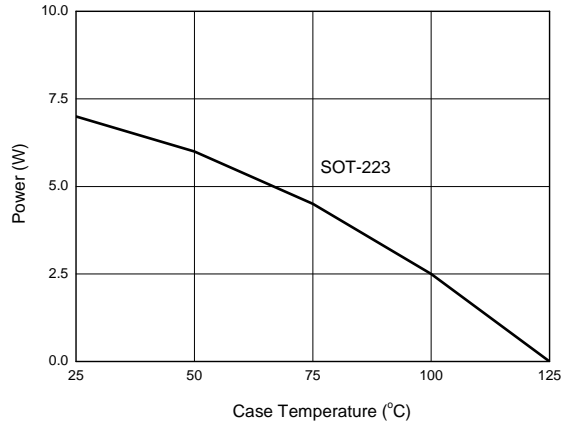

Figure 5. Maximum Power Dissipation

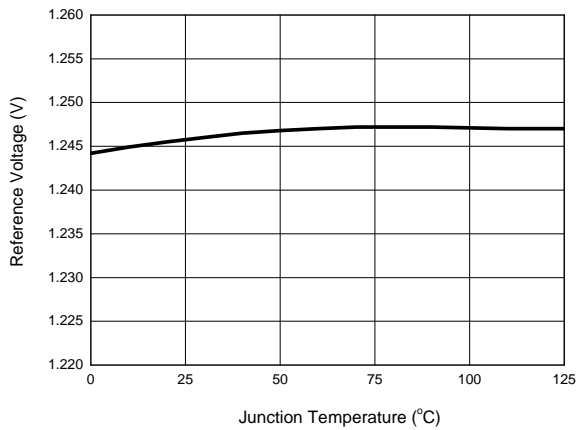

Figure 6. Reference Voltage vs. Junction Temperature

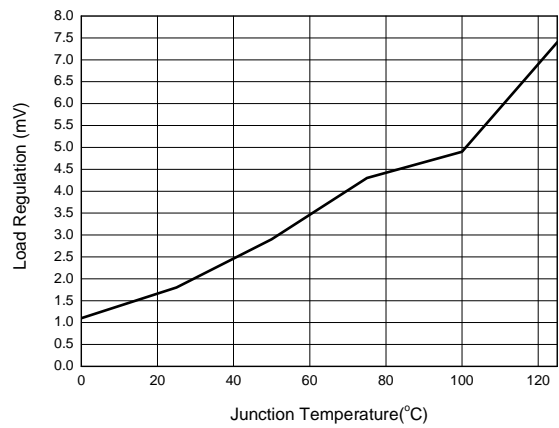

Figure 7. Load Regulation vs. Junction Temperature





**1.5A LOW DROPOUT LINEAR REGULATOR**

**AZ1086**

**Typical Performance Characteristics (Continued)**

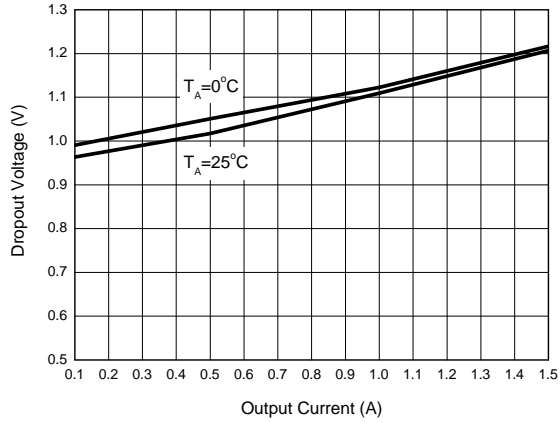

Figure 8. Dropout Voltage vs. Output Current

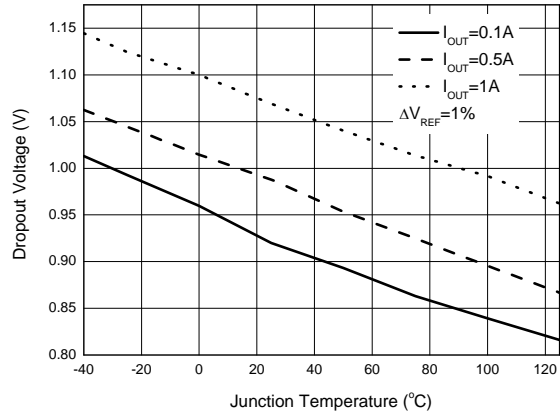

Figure 9. Dropout Voltage vs. Junction Temperature

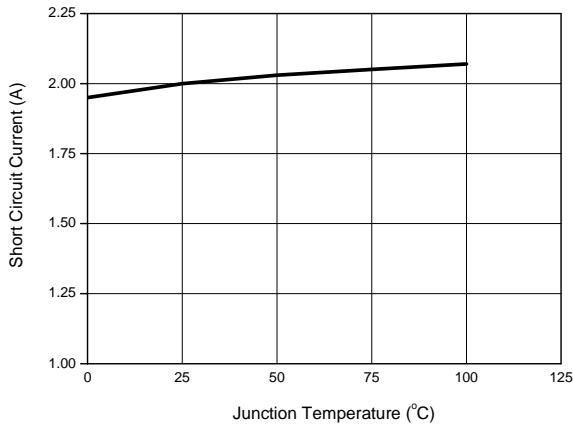

Figure 10. Short Circuit Current vs. Junction Temperature

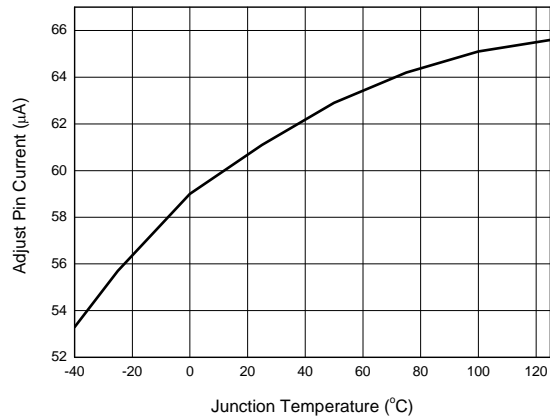

Figure 11. Adjust Pin Current vs. Junction Temperature



**1.5A LOW DROPOUT LINEAR REGULATOR**

**AZ1086**

**Typical Performance Characteristics (Continued)**

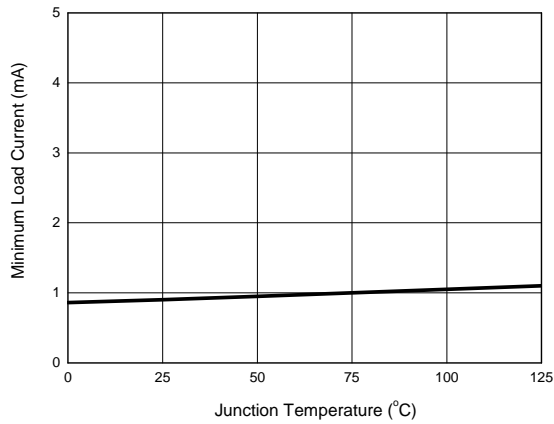

Figure 12. Minimum Load Current vs. Junction Temperature

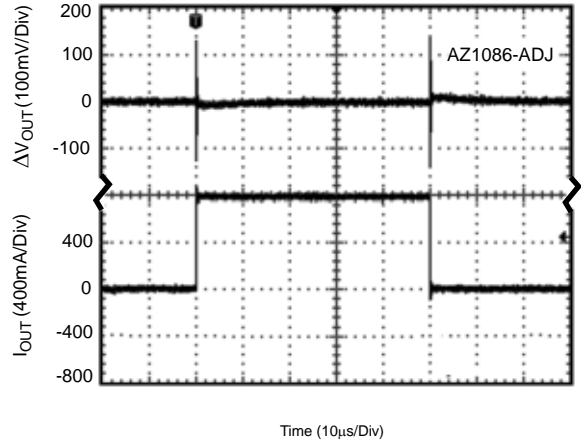

Figure 13. Load Transient Response  
(Conditions:  $V_{IN}=4.8V$ ,  $V_{OUT}=3.3V$ ,  $I_{OUT}=0.1$  to  $0.75A$ ,  $C_{IN}=C_{OUT}=10\mu F$ )

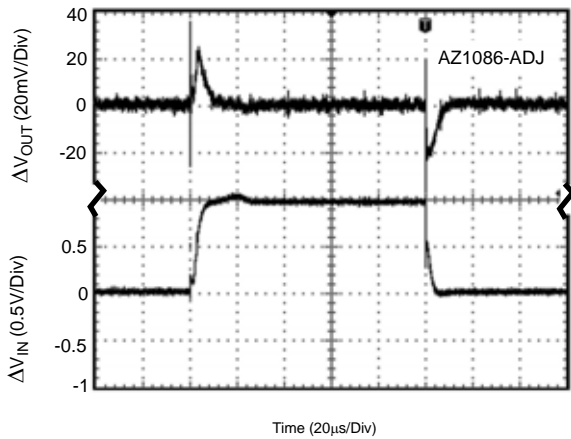

Figure 14. Line Transient Response  
(Conditions:  $V_{IN}=4.8V$  to  $5.8V$ ,  $V_{OUT}=3.3V$ ,  $I_{OUT}=0.1A$ ,  $C_{IN}=1\mu F$ ,  $C_{OUT}=10\mu F$ )

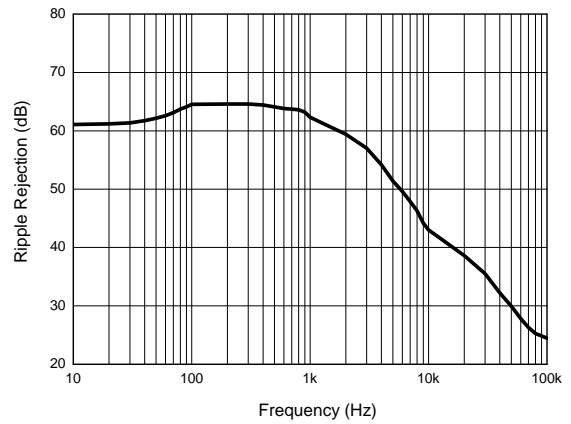

Figure 15. Ripple Rejection vs. Frequency



**1.5A LOW DROPOUT LINEAR REGULATOR**

**AZ1086**

**Typical Application**

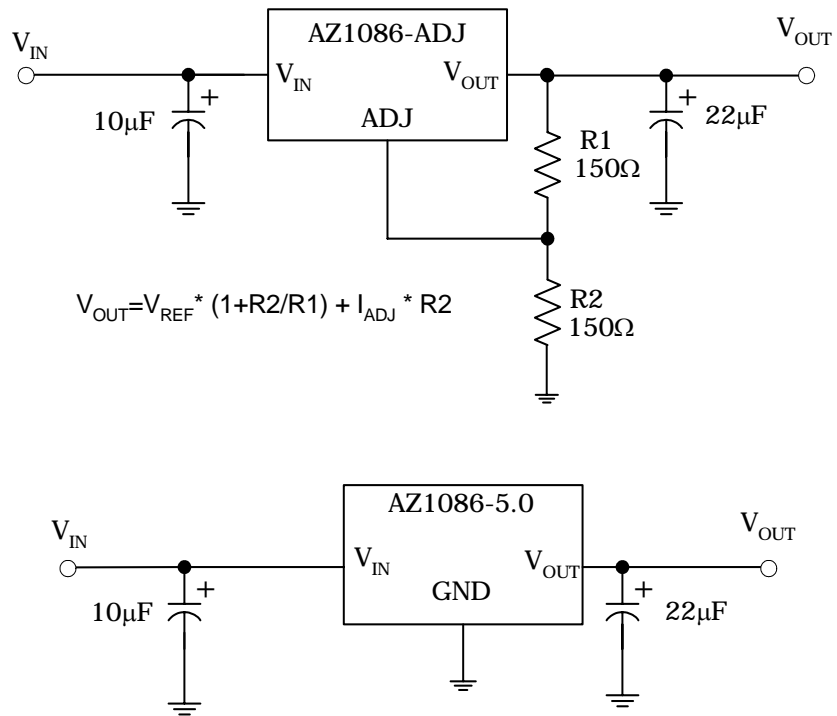

Figure 16. Typical Applications of AZ1086



**1.5A LOW DROPOUT LINEAR REGULATOR**

**AZ1086**

**Mechanical Dimensions**

**TO-263-3**

**Unit: mm(inch)**

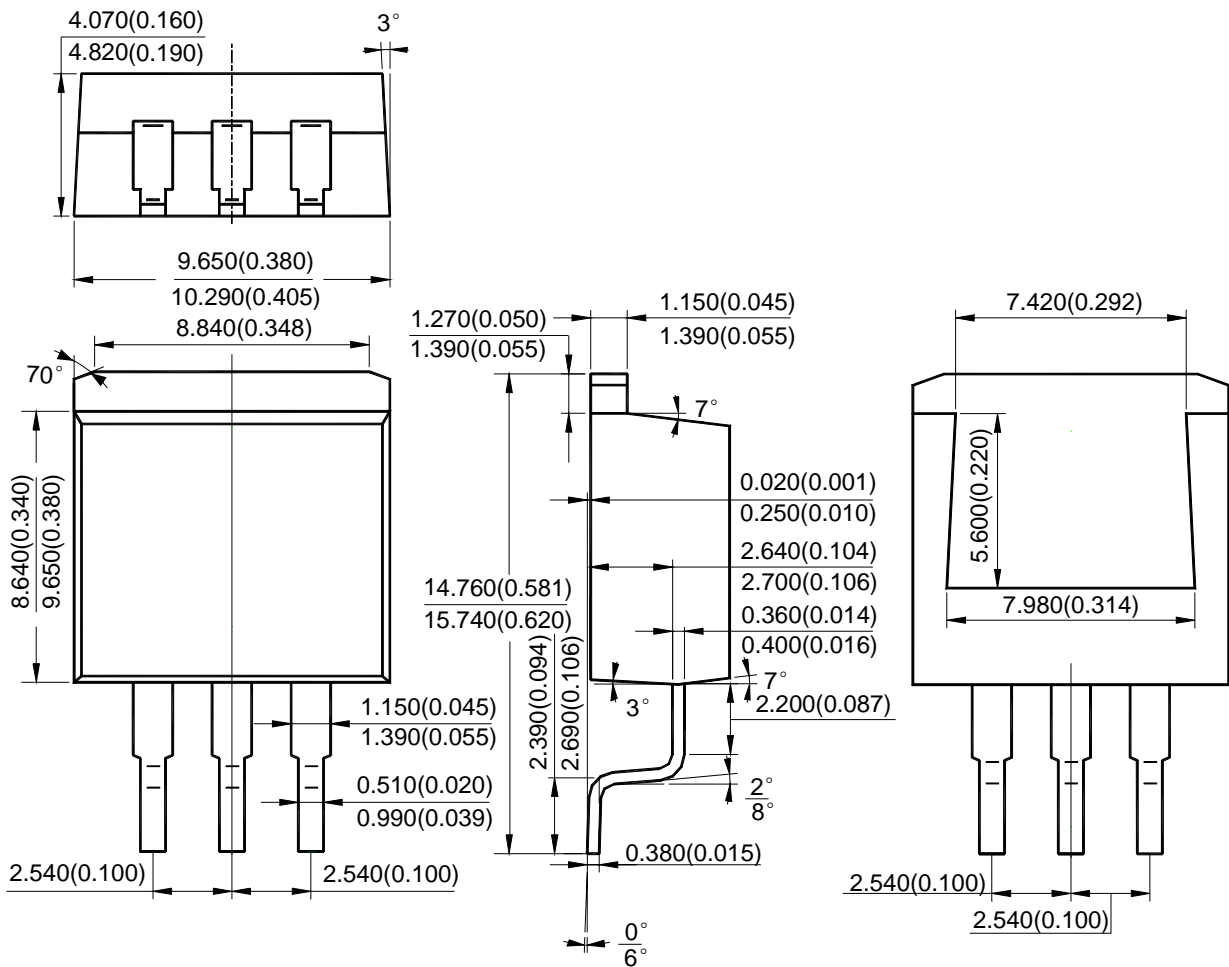



**1.5A LOW DROPOUT LINEAR REGULATOR**

**AZ1086**

**Mechanical Dimensions (Continued)**

**TO-220-3**

**Unit: mm(inch)**

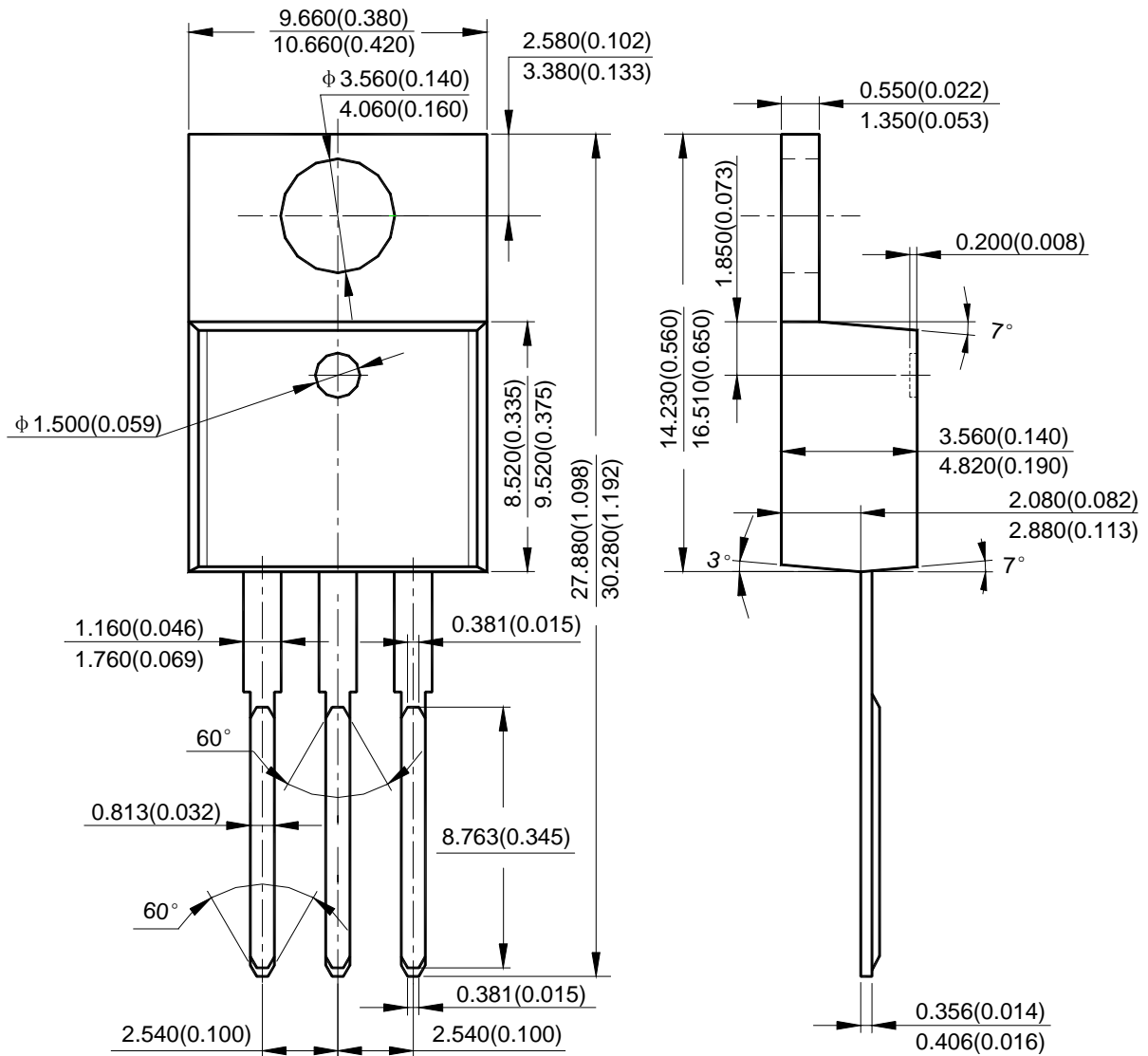



**1.5A LOW DROPOUT LINEAR REGULATOR**

**AZ1086**

**Mechanical Dimensions (Continued)**

**SOT-223**

**Unit: mm(inch)**

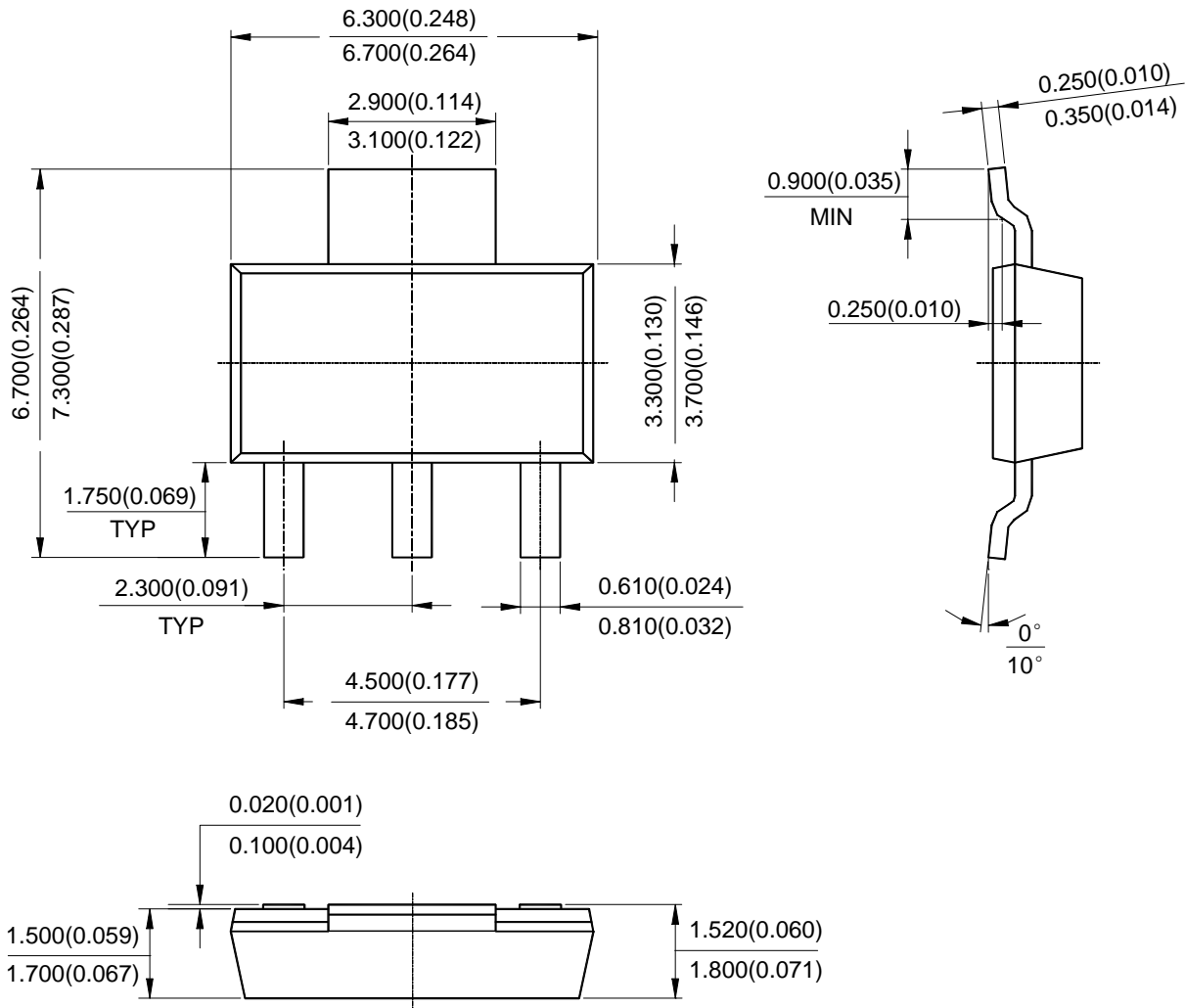



**1.5A LOW DROPOUT LINEAR REGULATOR**

**AZ1086**

**Mechanical Dimensions (Continued)**

**TO-252-2 (1)**

**Unit: mm(inch)**

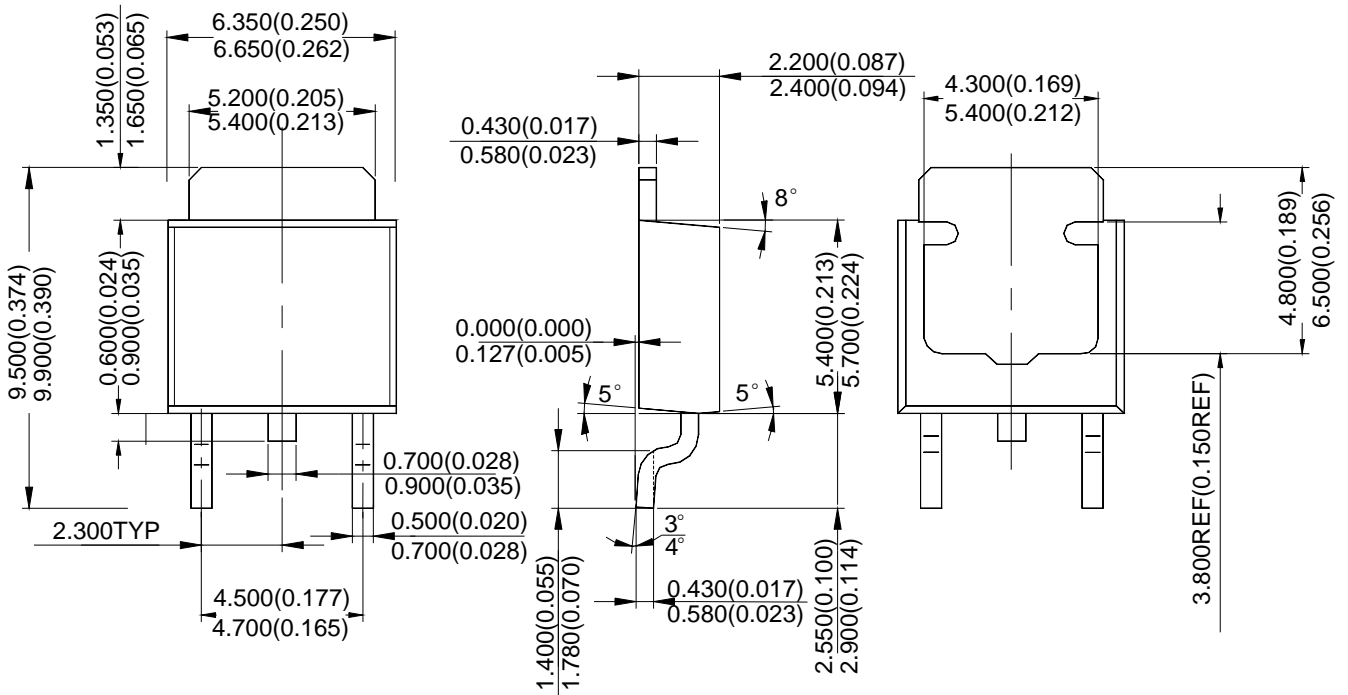



BCD Semiconductor Manufacturing Limited

<http://www.bcdsemi.com>

### IMPORTANT NOTICE

BCD Semiconductor Manufacturing Limited reserves the right to make changes without further notice to any products or specifications herein. BCD Semiconductor Manufacturing Limited does not assume any responsibility for use of any its products for any particular purpose, nor does BCD Semiconductor Manufacturing Limited assume any liability arising out of the application or use of any its products or circuits. BCD Semiconductor Manufacturing Limited does not convey any license under its patent rights or other rights nor the rights of others.

---

#### MAIN SITE

**BCD Semiconductor Manufacturing Limited**  
- Wafer Fab  
Shanghai SIM-BCD Semiconductor Manufacturing Limited  
800, Yi Shan Road, Shanghai 200233, China  
Tel: +86-21-6485 1491, Fax: +86-21-5450 0008

**BCD Semiconductor Manufacturing Limited**  
- IC Design Group  
Advanced Analog Circuits (Shanghai) Corporation  
8F, Zone B, 900, Yi Shan Road, Shanghai 200233, China  
Tel: +86-21-6495 9539, Fax: +86-21-6485 9673

#### REGIONAL SALES OFFICE

**Shenzhen Office**  
Shanghai SIM-BCD Semiconductor Manufacturing Co., Ltd. Shenzhen Office  
Advanced Analog Circuits (Shanghai) Corporation Shenzhen Office  
Room E, 5F, Noble Center, No.1006, 3rd Fuzhong Road, Futian District, Shenzhen 518026, China  
Tel: +86-755-8826 7951  
Fax: +86-755-8826 7865

**Taiwan Office**  
BCD Semiconductor (Taiwan) Company Limited  
4F, 298-1, Rui Guang Road, Nei-Hu District, Taipei,  
Taiwan  
Tel: +886-2-2656 2808  
Fax: +886-2-2656 2806

**USA Office**  
BCD Semiconductor Corporation  
30920 Huntwood Ave. Hayward,  
CA 94544, U.S.A  
Tel : +1-510-324-2988  
Fax: +1-510-324-2788