

## 100mA Low Dropout Voltage Regulator

### FEATURES

- 3.3V and 3.5V Versions
- Output Current in Excess of 100 mA
- Input-Output Differential is 0.3 at 100mA
- Mirror-Image Insertion Protection
- Internal Thermal Protection
- Available in TO-92 and SOT-89 Packages
- Improved Version of the Industry Standard LM2931
- Reverse Battery, Internal Short Circuit, 20V Reverse Transient and 60V Load Dump Protection
- Available with either 2% or 3% Output Accuracy at 25°C

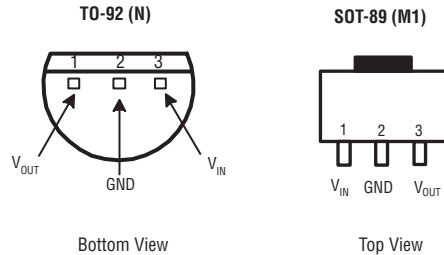

*Now Available in Lead Free Packaging*

### APPLICATIONS

- Portable Instrumentation
- Cordless Telephones
- Radio Control Systems

### DESCRIPTION

The SPX2931 is a low power, positive voltage regulator. This device is an excellent choice for use in battery-powered applications such as cordless telephones, radio control systems, and portable computers. The SPX2931 features offers very low quiescent currents (0.4 mA), and very low drop output voltage (50 mV at light load and 300 mV at 100 mA). The SPX2931 is offered in a 3-pin TO-92, and SOT-89 package.

### TYPICAL APPLICATIONS CIRCUIT

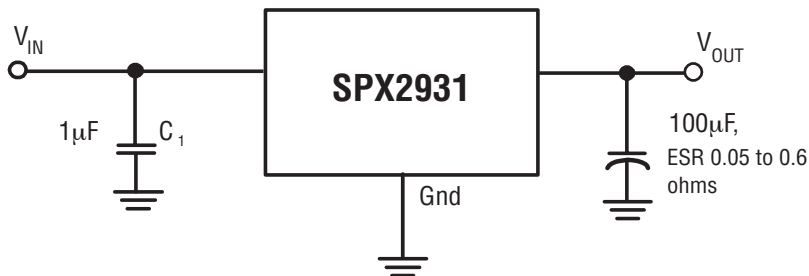

## ABSOLUTE MAXIMUM RATINGS

Power Dissipation (note 3)	Internally limited
Lead Temp (soldering, 5 seconds)	260°C
Storage Temperature Range	-65°C to +150°C
Input Supply Voltage Range	-0.3 to +30V
ESD Rating (note 4)	2kV

## RECOMMENDED OPERATING CONDITIONS

Input Voltage Range	3.0 to 26V
Operating Junction Temperature Range	-40°C to 125°C
TO-92 <sub>JA</sub>	160°C/W
SOT-89 <sub>JA</sub>	110°C/W

## ELECTRICAL CHARACTERISTICS

at  $V_{IN}=6V$ ,  $T_A = 25^\circ C$ ,  $I_O = 10\text{ mA}$ ,  $C_{OUT} = 100\ \mu F$ , unless otherwise specified. (Note 1)

PARAMETER	CONDITIONS	MIN	TYP	MAX	MIN	TYP	MAX	UNITS
<b>3.3V Version</b>								
Output Voltage (Note 2)	$4V < V_{IN} < 26V$ , $I_O = 100\text{ mA}$ over temp.	3.234 <b>3.201</b>	3.300	3.366 <b>3.399</b>	3.201 <b>3.135</b>	3.300	3.399 <b>3.465</b>	V
<b>3.5V Version</b>								
Output Voltage (Note 2)	$4.5V < V_{IN} < 26V$ , $I_O = 100\text{mA}$ Over Temp.	3.430 <b>3.395</b>	3.500	3.570 <b>3.605</b>	3.395 <b>3.325</b>	3.500	3.605 <b>3.675</b>	V
<b>All Voltage Options</b>								
Long Term Stability			20			20		mV/1000hr
Line Regulation	$9V < V_{IN} < 16V$ , $4.5V < V_{IN} < 26V$		2.0 4.0	10 30		4.0	30	mV
Load Regulation	$5\text{mA} < I_O < 150\text{mA}$		14	50		14	50	mV
Dropout Voltage	$I_O = 10\text{mA}$ $I_O = 150\text{mA}$		0.05 0.3	0.2 0.6		0.05 0.3	0.2 0.6	V
Quiescent Current	$I_O = 10\text{mA}$ , $4.5V < V_{IN} < 26V$ $-40^\circ C < T_J < 85^\circ C$ $I_O = 150\text{mA}$ , $V_{IN} = 14V$ , $T_J = 25^\circ C$		0.4 15	1.0		0.4 15	1.0	mA
Output Noise Voltage	10Hz-100kHz, $C_{OUT} = 100\ \mu F$		500			500		$\mu V_{RMS}$
Ripple Rejection	$F_O = 120\text{Hz}$		80			80		dB
Maximum Operational Input Voltage		26			26			V
Maximum Line Transient	$R_L = 500\ \Omega$ , 100ms	60	70		50	70		V
Reverse Polarity Input Voltage, DC	$V_O > -0.3V$ , $R_L = 500\ \Omega$	-15	-30		-15	-30		V
Reverse Polarity Input Voltage, Transient	1% Duty Cycle, $\tau < 100\text{ms}$ $R_L = 500\ \Omega$	-50	-80		-50	-80		V

### NOTES:

Note 1: See TYPICAL APPLICATIONS notes to ensure constant junction temperature, low duty cycle pulse testing used.

Note 2: All limits are at 25°C or over the full operating junction temperature range of -40°C to +125°C.

Note 3: The maximum power dissipation is a function of maximum junction temperature, total thermal resistance, and ambient temperature.

Note 4: Human body model, 100pF discharged through 1.5k $\Omega$ .

# TYPICAL PERFORMANCE CHARACTERISTICS

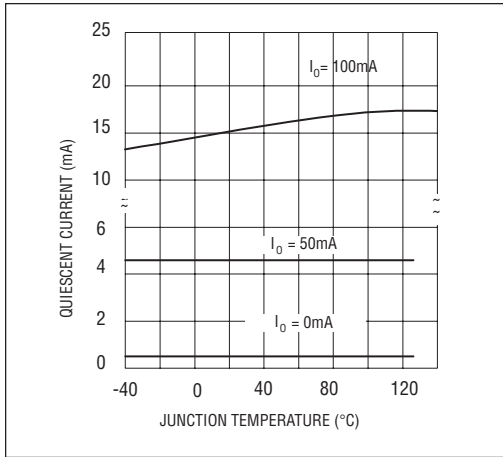

Figure 1. Quiescent Current

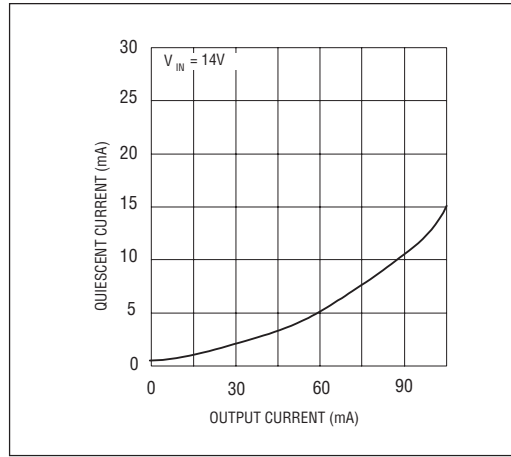

Figure 2. Quiescent Current

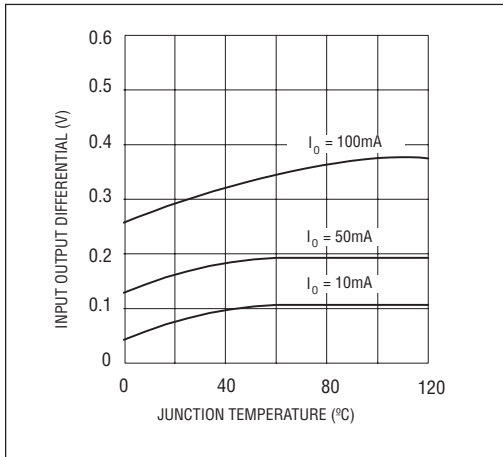

Figure 3. Dropout Voltage

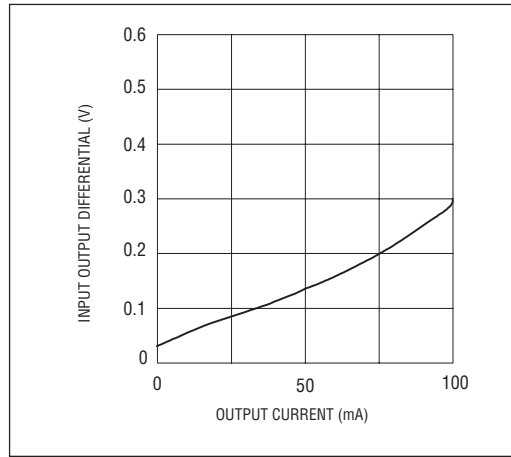

Figure 4. Dropout Voltage

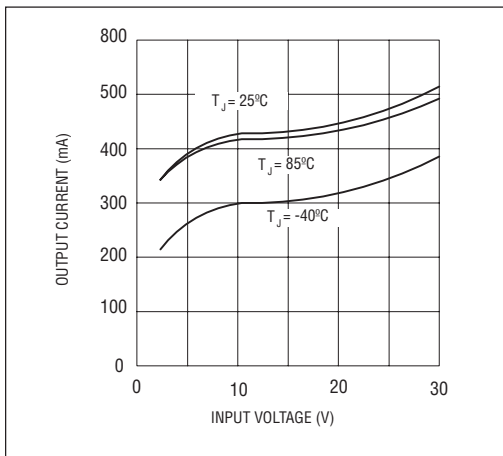

Figure 5. Peak Output Current

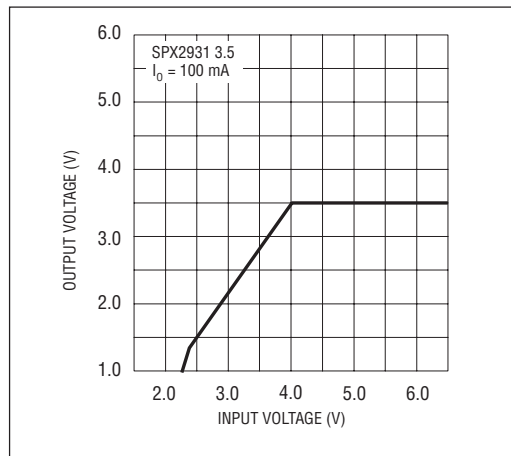

Figure 6. Low Voltage Behavior

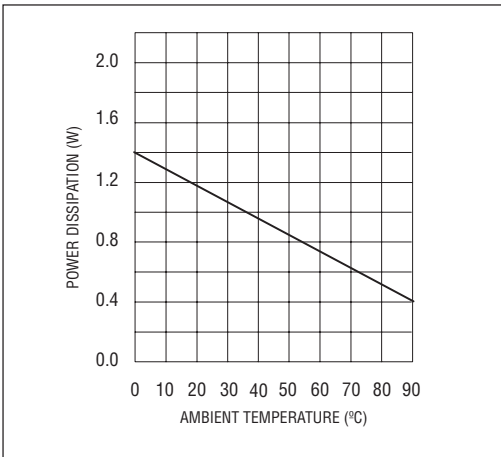

Figure 7. Maximum Power Dissipation (SOT89)

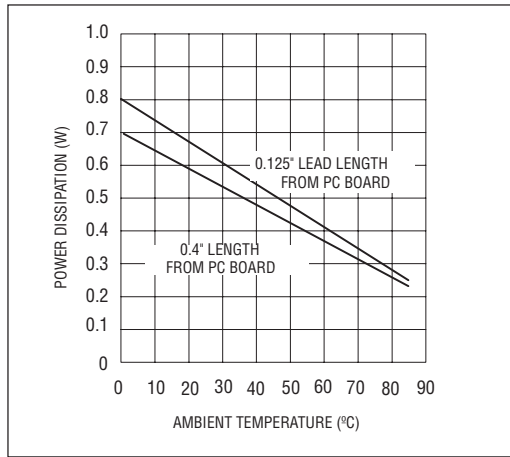

Figure 8. Maximum Power Dissipation (TO-92)

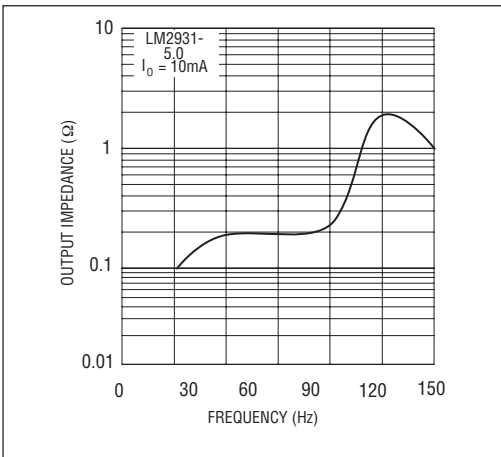

Figure 9. Output Impedance

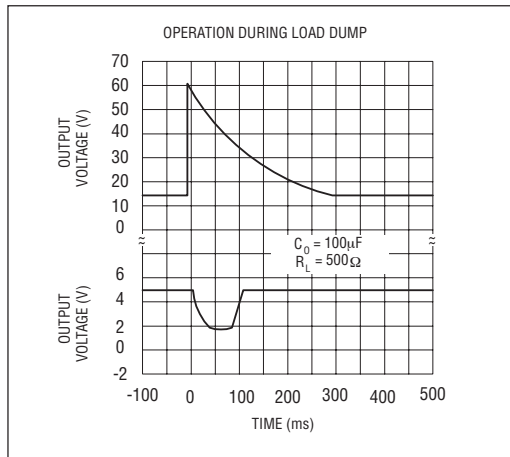

Figure 10. Operation During Load Dump

**APPLICATION INFORMATION**

The SPX2931 requires an output capacitor for device stability. The value required varies greatly depending upon the application circuit and other factors. The high frequency characteristics of electrolytic capacitors depend greatly on the type and also on the manufacturer. Sometimes bench testing is the only means to determine the proper capacitor type and value. The high quality 100°F aluminum electrolytic covers all general application circuits, this stability can be obtained with a tantalum electrolytic value of 47°F.

Another critical point of electrolytic characteristics is its performance over temperature. The SPX2931 is designed to operate starting at -40°C which may not be true in the case of electrolytic. Higher temperatures generally no problem. The electrolytic type in aluminum will freeze around -30°C. This could cause an oscillation at output of regulator. At a lower temperature requirement by many applications the capacitor should maintain its performance. So as a result, for an application which regulator junction temperature does not exceed 25°C, the output capacitor can be reduced by the factor of two over the value needed for the entire temperature range.

In most applications the SPX2931 is operating at few milliamps. In these applications the output capacitance can be further reduced. For example, when the regulator is running at 10mA output current the output capacitance value is half compared to the same regulator that is running at 100 mA. The value decreases with higher output voltages, since the internal loop gain is reduced.

The worst case occurs at the lower temperature and maximum operating currents, the entire circuit and the electrolytic, should be cooled down to the minimum temperature. The minimum of 0.6 volts required at the input of regulator above the output to keep the power dissipation and die heating to its minimum. After the value for the capacitor has been determined for actual use, the value should be doubled.

---

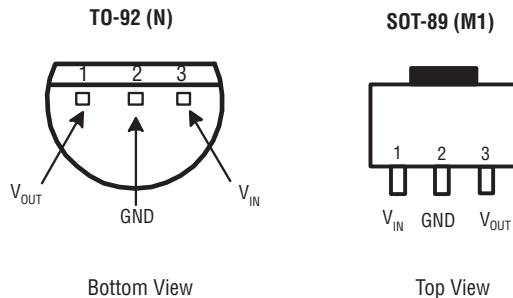
**PACKAGE PINOUTS**

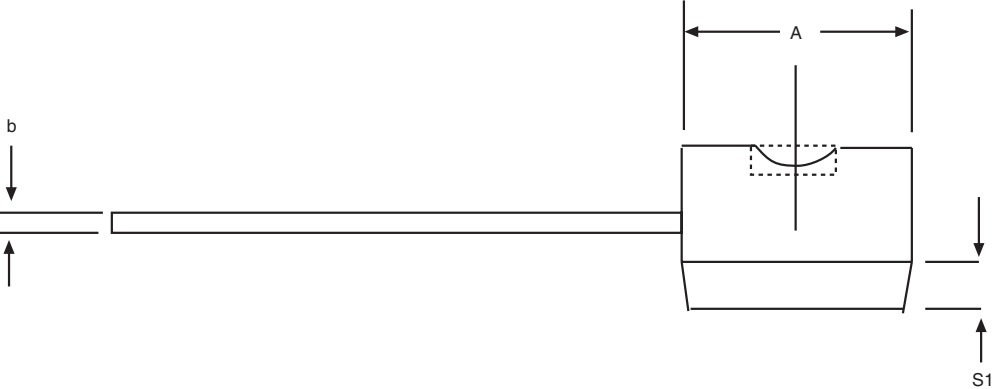
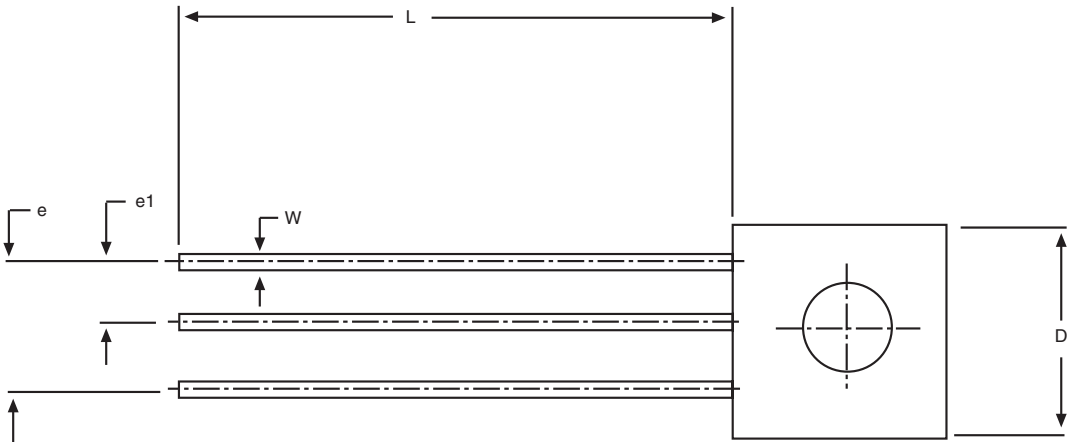

3 Pin TO-92			
SYMBOL	MIN	NOM	MAX
A	0.17	-	0.195
b	0.014	-	0.02
E	0.13	-	0.155
e	0.95	-	0.105
e1	0.045	-	0.055
L	0.5	-	0.61
R	0.085	-	0.095
S1	0.045	-	0.06
W	0.016	-	0.022
D	0.175	-	0.195
a	4°	-	6°

Note: Dimensions in (inches)

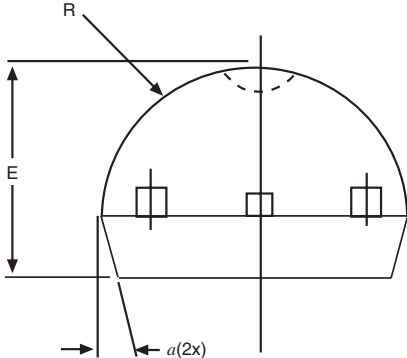

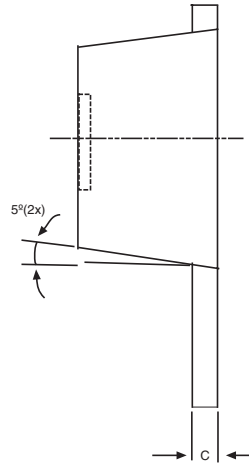
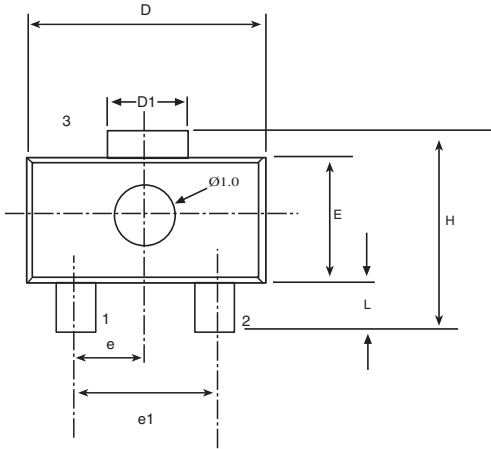

3 Pin SOT-89			
SYMBOL	MIN	NOM	MAX
b	0.36	0.42	0.48
L	0.8	-	1.2
b1	0.41	0.47	0.53
C	0.38	0.4	0.43
D	4.4	4.5	4.6
D1	1.4	1.6	1.75
H	3.94	-	4.25
E	2.4	2.5	2.6
e	1.45	1.5	1.55
e1	2.9	3	3.1

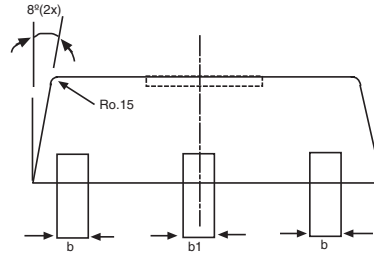

Note: Dimensions in (mm)

---

**ORDERING INFORMATION**

<b>PART NUMBER</b>	<b>ACC.</b>	<b>OUTPUT VOLTAGE</b>	<b>PACKAGE</b>
SPX2931AM1-3.3	2%	3.3V	3 lead SOT-89
SPX2931AM1-3.3/TR	2%	3.3V	3 lead SOT-89
SPX2931AM1-3.5	2%	3.5V	3 lead SOT-89
SPX2931AM1-3.5/TR	2%	3.5V	3 lead SOT-89
SPX2931AN-3.3	2%	3.3V	3 lead TO-92
SPX2931AN-3.3/TR	2%	3.3V	3 lead TO-92
SPX2931AN-3.5	2%	3.5V	3 lead TO-92
SPX2931AN-3.5/TR	2%	3.5V	3 lead TO-92
SPX2931M1-3.3	3%	3.3V	3 Lead SOT-89
SPX2931M1-3.3/TR	3%	3.3V	3 Lead SOT-89
SPX2931M1-3.5	3%	3.5V	3 Lead SOT-89
SPX2931M1-3.5/TR	3%	3.5V	3 Lead SOT-89
SPX2931N-3.3	3%	3.3V	3 Lead TO-92
SPX2931N-3.3/TR	3%	3.3V	3 Lead TO-92
SPX2931N-3.5	3%	3.5V	3 Lead TO-92
SPX2931N-3.5/TR	3%	3.5V	3 Lead TO-92

Available in lead free packaging. To order add "-L" suffix to part number.  
Example: SPX2931AN-3.3/TR = standard; SPX2931AN-L-3.3/TR = lead free

/TR = Tape and Reel

Pack quantity is 2,000 for TO-92 and 2,500 for SOT-89.

 [CLICK HERE TO ORDER SAMPLES](#) 



ANALOG EXCELLENCE

**Sipex Corporation**

**Headquarters and  
Sales Office**  
233 South Hillview Drive  
Milpitas, CA 95035  
TEL: (408) 934-7500  
FAX: (408) 935-7600

Sipex Corporation reserves the right to make changes to any products described herein. Sipex does not assume any liability arising out of the application or use of any product or circuit described herein; neither does it convey any license under its patent rights nor the rights of others.