

# SF21 THRU SF28

## List

List..... 1

Package outline..... 2

Features..... 2

Mechanical data..... 2

Maximum ratings .....2

Rating and characteristic curves..... 3

Pinning information.....4

Marking..... 4

Taping & bulk specifications for AXIAL devices..... 4

Suggested thermal profiles for soldering processes..... 5

High reliability test capabilities.....6

# SF21 THRU SF28

## 2.0A Axial Leaded Super Fast Rectifiers-50-600V

### Features

- Axial lead type devices for through hole design
- High current capability.
- Superfast recovery time for switching mode application.
- High surge current capability.
- Silicon rubber coating chip junction.
- Lead-free parts meet RoHS requirements.
- Suffix "-H" indicates Halogen free parts, ex. SF21-H.

### Mechanical data

- Epoxy : UL94-V0 rated flame retardant
- Case : Molded plastic, DO-15
- Lead : Axial leads, solderable per MIL-STD-202, Method 208 guaranteed
- Polarity: Color band denotes cathode end
- Mounting Position : Any
- Weight : Approximated 0.40 gram

### Package outline

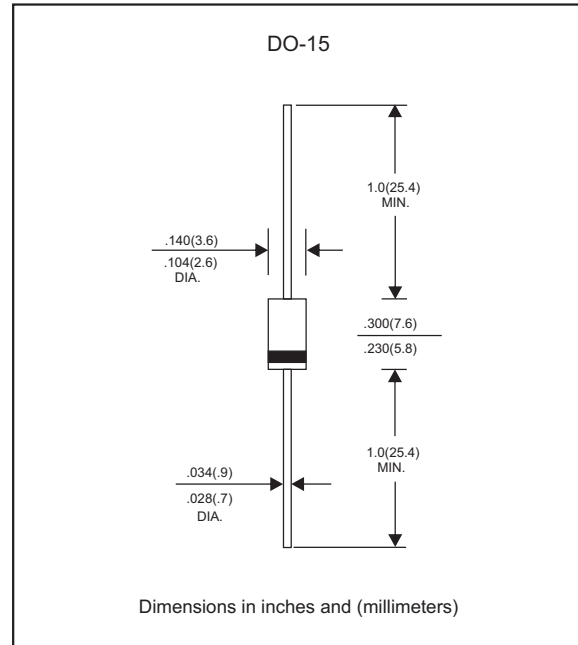

### Maximum ratings and Electrical Characteristics (AT $T_A=25^\circ\text{C}$ unless otherwise noted)

PARAMETER	CONDITIONS	Symbol	MIN.	TYP.	MAX.	UNIT
Forward rectified current	Ambient temperature = $55^\circ\text{C}$	$I_o$			2.0	A
Forward surge current	8.3ms single half sine-wave (JEDEC method)	$I_{FSM}$			60	A
Reverse current	$V_R = V_{RRM}$ $T_J = 25^\circ\text{C}$	$I_R$			5.0	$\mu\text{A}$
	$V_R = V_{RRM}$ $T_J = 100^\circ\text{C}$				150	
Diode junction capacitance	f=1MHz and applied 4V DC reverse voltage	$C_j$		60		pF
Storage temperature		$T_{STG}$	-65		+175	$^\circ\text{C}$

SYMBOLS	$V_{RRM}^{*1}$ (V)	$V_{RMS}^{*2}$ (V)	$V_R^{*3}$ (V)	$V_F^{*4}$ (V)	$t_{rr}^{*5}$ (ns)	Operating temperature $T_J, (^\circ\text{C})$
SF21	50	35	50	0.95	35	-55 to +125
SF22	100	70	100			
SF23	150	105	150			
SF24	200	140	200			
SF25	300	210	300	1.25	35	-55 to +125
SF26	400	280	400			
SF27	500	350	500			
SF28	600	420	600	1.70	35	-55 to +125

- \*1 Repetitive peak reverse voltage
- \*2 RMS voltage
- \*3 Continuous reverse voltage
- \*4 Maximum forward voltage@ $I_F=2.0\text{A}$
- \*5 Maximum Reverse recovery time, note 1

Note 1. Reverse recovery time test condition,  $I_F=0.5\text{A}$ ,  $I_R=1.0\text{A}$ ,  $I_{RR}=0.25\text{A}$

# Rating and characteristic curves (SF21 THRU SF28)

FIG.1- TEST CIRCUIT DIAGRAM AND REVERSE RECOVERY TIME CHARACTERISTIC

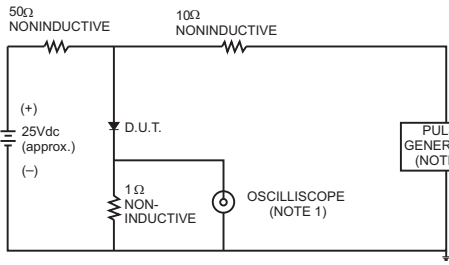

NOTES: 1. Rise Time= 7ns max., Input Impedance= 1 megohm.22pF.  
2. Rise Time= 10ns max., Source Impedance= 50 ohms.

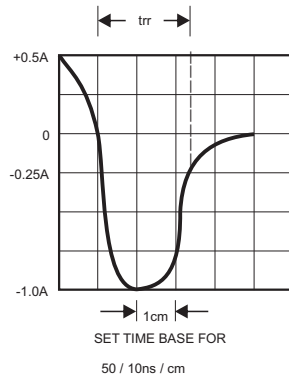

FIG.2-TYPICAL FORWARD CURRENT DERATING CURVE

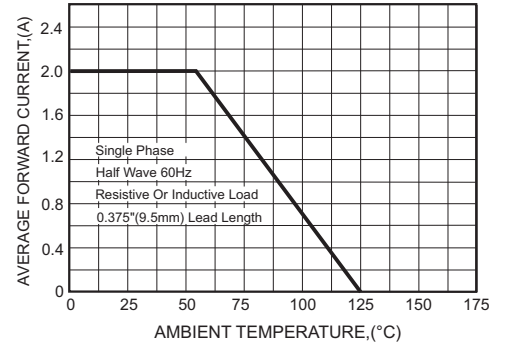

FIG.3-TYPICAL FORWARD CHARACTERISTICS

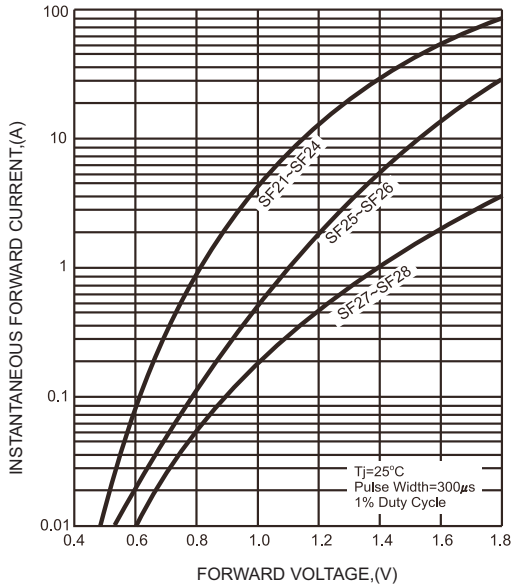

FIG.4-TYPICAL REVERSE CHARACTERISTICS

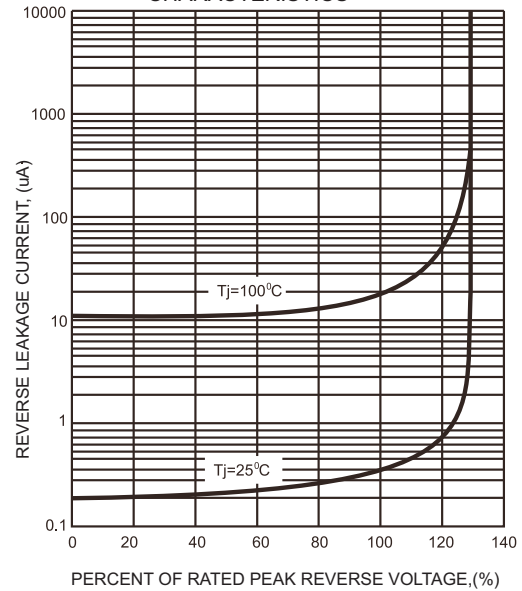

FIG.5-MAXIMUM NON-REPETITIVE FORWARD SURGE CURRENT

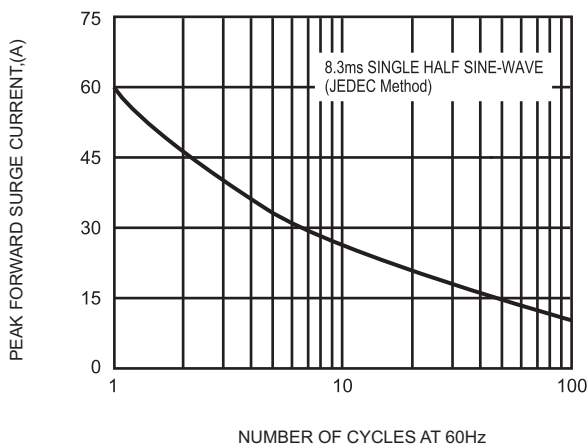
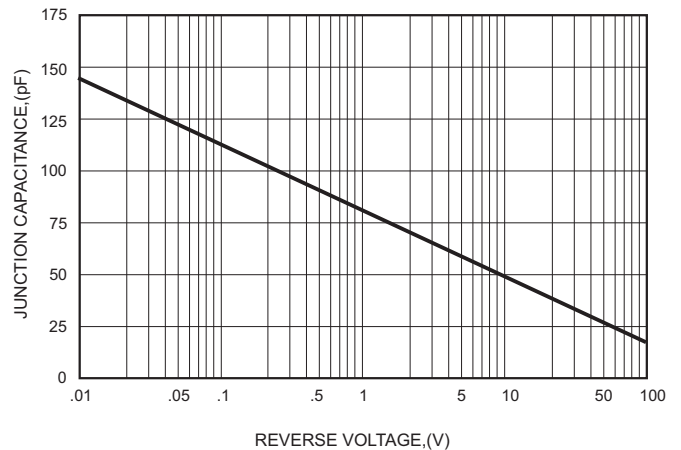



FIG.6-TYPICAL JUNCTION CAPACITANCE



# SF21 THRU SF28

## Pinning information

Pin	Simplified outline	Symbol
Pin1 cathode Pin2 anode	1  2	1  2

## Marking

Type number	Marking code
SF21	SF21
SF22	SF22
SF23	SF23
SF24	SF24
SF25	SF25
SF26	SF26
SF27	SF27
SF28	SF28

## Taping & bulk specifications for AXIAL devices

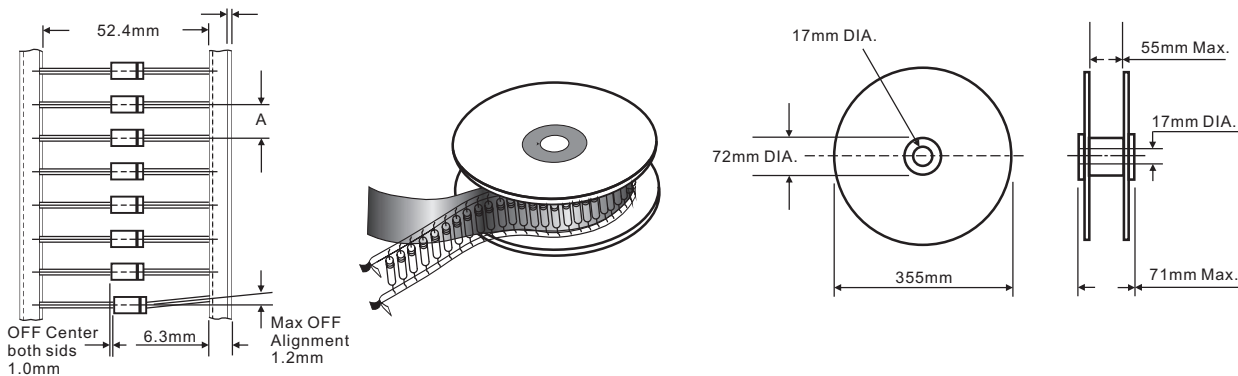

### REEL PACKING

DEVICE CASE TYPE	Q'TY 1 (PCS / REEL)	COMPONENT SPACING "A" in FIG. A	CARTON SIZE (m/m)	Q'TY 2 (PCS / CARTON)	APPROX. CROSS WEIGHT(kg)
DO-15	4,000	5 mm	380 * 340 * 370	16,000	9.9

### AMMO PACKING

DEVICE CASE TYPE	Q'TY 1 (PCS / BOX)	INNER BOX SIZE (m/m)	CARTON SIZE (m/m)	Q'TY 2 (PCS / CARTON)	APPROX. CROSS WEIGHT(kg)
DO-15	3,000	260 * 83 * 160	440 * 270 * 340	30,000	14.3

# SF21 THRU SF28

**BULK PACKING**

DEVICE CASE TYPE	Q'TY 1 (PCS / BOX)	INNER BOX SIZE (m/m)	CARTON SIZE (m/m)	Q'TY 2 (PCS / CARTON)	APPROX. CROSS WEIGHT(kg)
DO-15	500	194 * 84 * 20	465 * 220 * 260	25,000	12.9

**Suggested thermal profiles for soldering processes**

1. Lead free temperature profile wave-soldering

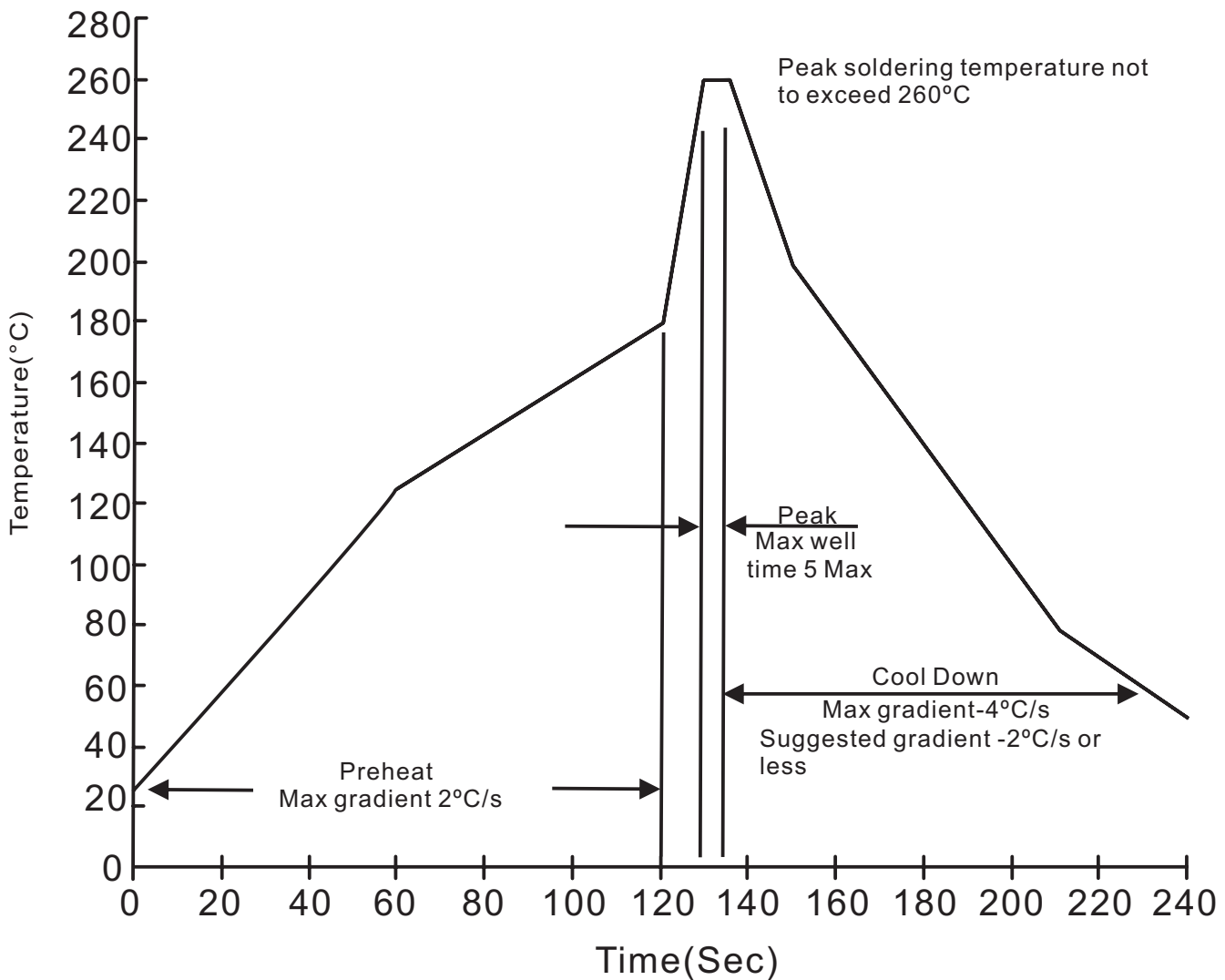

**SF21 THRU SF28****High reliability test capabilities**

Item Test	Conditions	Reference
1. Solder Resistance	at 260±5°C for 10±2sec. immerse body into solder 1/16"±1/32"	MIL-STD-750D METHOD-2031
2. Solderability	at 245±5°C for 5 sec.	MIL-STD-202F METHOD-208
3. Pull Test	1.0kg in axial lead direction for 10 sec. $I_F = I_O$	MIL-STD-202F METHOD-211A
4. Bend Lead	1.0kg weight applied to each lead bending arc 90°±5° for 3 times	MIL-STD-202F METHOD-211A
5. High Temperature Reverse Bias	$V_R = 80\%$ rate at $T_J = 125^\circ\text{C}$ for 168 hrs.	MIL-STD-750D METHOD-1038
6. Forward Operation Life	Rated average rectifier current at $T_A = 25^\circ\text{C}$ for 500hrs. $T_A = 25^\circ\text{C}$ , $I_F = I_O$	MIL-STD-750D METHOD-1027
7. Intermittent Operation Life	On state: power on for 5 min. off state: power off for 5 min, on and off for 500 cycles.	MIL-STD-750D METHOD-1036
8. Pressure Cooker	15P <sub>SIG</sub> at $T_A = 121^\circ\text{C}$ for 4 hrs.	JESD22-A102
9. Temperature Cycling	-55°C to +125°C dwelled for 30 min. and transferred for 5min. total 10 cycles.	MIL-STD-750D METHOD-1051
10. Forward Surge	8.3ms single half sine-wave one surge.	MIL-STD-750D METHOD-4066-2
11. Humidity	at $T_A = 85^\circ\text{C}$ , RH=85% for 1000hrs.	MIL-STD-750D METHOD-1021
12. High Temperature Storage Life	at 175°C for 1000 hrs.	MIL-STD-750D METHOD-1031