

Rochester Electronics Manufactured Components

Rochester branded components are manufactured using either die/wafers purchased from the original suppliers or Rochester wafers recreated from the original IP. All recreations are done with the approval of the OCM.

Parts are tested using original factory test programs or Rochester developed test solutions to guarantee product meets or exceed the OCM data sheet.

Quality Overview

- ISO-9001
- AS9120 certification
- Qualified Manufacturers List (QML) MIL-PRF-35835
 - Class Q Military
 - Class V Space Level
- Qualified Suppliers List of Distributors (QSLD)
 - Rochester is a critical supplier to DLA and meets all industry and DLA standards.

Rochester Electronics, LLC is committed to supplying products that satisfy customer expectations for quality and are equal to those originally supplied by industry manufacturers.

The original manufacturer's datasheet accompanying this document reflects the performance and specifications of the Rochester manufactured version of this device. Rochester Electronics guarantees the performance of its semiconductor products to the original OEM specifications. 'Typical' values are for reference purposes only. Certain minimum or maximum ratings may be based on product characterization, design, simulation, or sample testing.

MC74AC32, MC74ACT32

Quad 2-Input OR Gate

- Outputs Source/Sink 24 mA
- 'ACT32 Has TTL Compatible Inputs

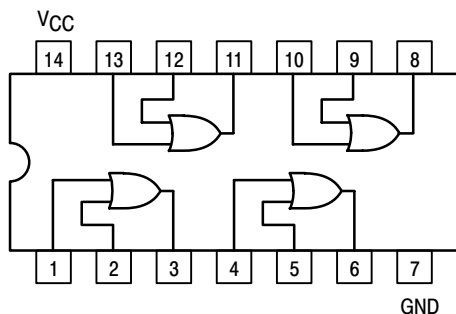

Figure 1. Pinout: 14-Lead Packages Conductors (Top View)

MAXIMUM RATINGS*

Rating	Symbol	Value	Unit
DC Supply Voltage (Referenced to GND)	V_{CC}	-0.5 to +7.0	V
DC Input Voltage (Referenced to GND)	V_{in}	-0.5 to $V_{CC} + 0.5$	V
DC Output Voltage (Referenced to GND)	V_{out}	-0.5 to $V_{CC} + 0.5$	V
DC Input Current, per Pin	I_{in}	± 20	mA
DC Output Sink/Source Current, per Pin	I_{out}	± 50	mA
DC V_{CC} or GND Current per Output Pin	I_{CC}	± 50	mA
Storage Temperature	T_{stg}	-65 to +150	$^{\circ}C$

*Maximum Ratings are those values beyond which damage to the device may occur. Functional operation should be restricted to the Recommended Operating Conditions.



ON Semiconductor™

<http://onsemi.com>

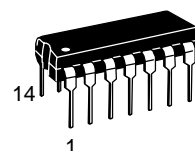

PDIP-14
N SUFFIX
CASE 646

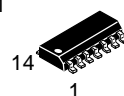

SO-14
D SUFFIX
CASE 751A

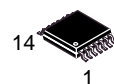

TSSOP-14
DT SUFFIX
CASE 948G

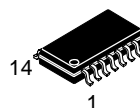

EIAJ-14
M SUFFIX
CASE 965

ORDERING INFORMATION

Device	Package	Shipping
MC74AC32N	PDIP-14	25 Units/Rail
MC74ACT32N	PDIP-14	25 Units/Rail
MC74AC32D	SOIC-14	55 Units/Rail
MC74AC32DR2	SOIC-14	2500 Tape & Reel
MC74ACT32D	SOIC-14	55 Units/Rail
MC74ACT32DR2	SOIC-14	2500 Tape & Reel
MC74AC32DT	TSSOP-14	96 Units/Rail
MC74AC32DTR2	TSSOP-14	2500 Tape & Reel
MC74ACT32DT	TSSOP-14	96 Units/Rail
MC74ACT32DTR2	TSSOP-14	2500 Tape & Reel
MC74AC32M	EIAJ-14	50 Units/Rail
MC74AC32MEL	EIAJ-14	2000 Tape & Reel
MC74ACT32M	EIAJ-14	50 Units/Rail
MC74ACT32MEL	EIAJ-14	2000 Tape & Reel

DEVICE MARKING INFORMATION

See general marking information in the device marking section on page 180 of this data sheet.

MC74AC32, MC74ACT32

RECOMMENDED OPERATING CONDITIONS

Symbol	Parameter	Min	Typ	Max	Unit	
V _{CC}	Supply Voltage	'AC	2.0	5.0	6.0	V
		'ACT	4.5	5.0	5.5	
V _{in} , V _{out}	DC Input Voltage, Output Voltage (Ref. to GND)	0	–	V _{CC}	V	
t _r , t _f	Input Rise and Fall Time (Note 1) 'AC Devices except Schmitt Inputs	V _{CC} @ 3.0 V	–	150	–	ns/V
		V _{CC} @ 4.5 V	–	40	–	
		V _{CC} @ 5.5 V	–	25	–	
t _r , t _f	Input Rise and Fall Time (Note 2) 'ACT Devices except Schmitt Inputs	V _{CC} @ 4.5 V	–	10	–	ns/V
		V _{CC} @ 5.5 V	–	8.0	–	
T _J	Junction Temperature (PDIP)	–	–	140	°C	
T _A	Operating Ambient Temperature Range	–40	25	85	°C	
I _{OH}	Output Current – High	–	–	–24	mA	
I _{OL}	Output Current – Low	–	–	24	mA	

1. V_{in} from 30% to 70% V_{CC}; see individual Data Sheets for devices that differ from the typical input rise and fall times.
2. V_{in} from 0.8 V to 2.0 V; see individual Data Sheets for devices that differ from the typical input rise and fall times.

DC CHARACTERISTICS

Symbol	Parameter	V _{CC} (V)	74AC		74AC		Unit	Conditions		
			T _A = +25°C		T _A = –40°C to +85°C					
			Typ	Guaranteed Limits						
V _{IH}	Minimum High Level Input Voltage	3.0	1.5	2.1	2.1	V	V _{OUT} = 0.1 V or V _{CC} – 0.1 V			
		4.5	2.25	3.15	3.15					
		5.5	2.75	3.85	3.85					
V _{IL}	Maximum Low Level Input Voltage	3.0	1.5	0.9	0.9	V	V _{OUT} = 0.1 V or V _{CC} – 0.1 V			
		4.5	2.25	1.35	1.35					
		5.5	2.75	1.65	1.65					
V _{OH}	Minimum High Level Output Voltage	3.0	2.99	2.9	2.9	V	I _{OUT} = –50 μA			
		4.5	4.49	4.4	4.4					
		5.5	5.49	5.4	5.4					
	3.0	–	2.56	2.46	V	*V _{IN} = V _{IL} or V _{IH} –12 mA I _{OH} –24 mA –24 mA				
							4.5	–	3.86	3.76
							5.5	–	4.86	4.76
V _{OL}	Maximum Low Level Output Voltage	3.0	0.002	0.1	0.1	V	I _{OUT} = 50 μA			
		4.5	0.001	0.1	0.1					
		5.5	0.001	0.1	0.1					
	3.0	–	0.36	0.44	V	*V _{IN} = V _{IL} or V _{IH} 12 mA I _{OL} 24 mA 24 mA				
							4.5	–	0.36	0.44
							5.5	–	0.36	0.44
I _{IN}	Maximum Input Leakage Current	5.5	–	±0.1	±1.0	μA	V _I = V _{CC} , GND			
I _{OLD}	†Minimum Dynamic Output Current	5.5	–	–	75	mA	V _{OLD} = 1.65 V Max			
I _{OHD}		5.5	–	–	–75	mA	V _{OHD} = 3.85 V Min			
I _{CC}	Maximum Quiescent Supply Current	5.5	–	4.0	40	μA	V _{IN} = V _{CC} or GND			

*All outputs loaded; thresholds on input associated with output under test.

†Maximum test duration 2.0 ms, one output loaded at a time.

NOTE: I_{IN} and I_{CC} @ 3.0 V are guaranteed to be less than or equal to the respective limit @ 5.5 V V_{CC}.

MC74AC32, MC74ACT32

AC CHARACTERISTICS (For Figures and Waveforms – See Section 3 of the ON Semiconductor FACT Data Book, DL138/D)

Symbol	Parameter	V _{CC} * (V)	74AC			74AC		Unit	Fig. No.
			T _A = +25°C C _L = 50 pF			T _A = -40°C to +85°C C _L = 50 pF			
			Min	Typ	Max	Min	Max		
t _{PLH}	Propagation Delay	3.3 5.0	1.5 1.5	7.0 5.5	9.0 7.5	1.5 1.0	10.0 8.5	ns	3-5
t _{PHL}	Propagation Delay	3.3 5.0	1.5 1.5	7.0 5.0	8.5 7.0	1.0 1.0	9.0 7.5	ns	3-5

*Voltage Range 3.3 V is 3.3 V ±0.3 V.
Voltage Range 5.0 V is 5.0 V ±0.5 V.

DC CHARACTERISTICS

Symbol	Parameter	V _{CC} (V)	74ACT		74ACT		Unit	Conditions
			T _A = +25°C		T _A = -40°C to +85°C			
			Typ	Guaranteed Limits	Typ	Guaranteed Limits		
V _{IH}	Minimum High Level Input Voltage	4.5	1.5	2.0	2.0	V	V _{OUT} = 0.1 V or V _{CC} - 0.1 V	
		5.5	1.5	2.0	2.0			
V _{IL}	Maximum Low Level Input Voltage	4.5	1.5	0.8	0.8	V	V _{OUT} = 0.1 V or V _{CC} - 0.1 V	
		5.5	1.5	0.8	0.8			
V _{OH}	Minimum High Level Output Voltage	4.5	4.49	4.4	4.4	V	I _{OUT} = -50 μA	
		5.5	5.49	5.4	5.4			
		4.5	-	3.86	3.76	V	*V _{IN} = V _{IL} or V _{IH} -24 mA I _{OH} -24 mA	
		5.5	-	4.86	4.76			
V _{OL}	Maximum Low Level Output Voltage	4.5	0.001	0.1	0.1	V	I _{OUT} = 50 μA	
		5.5	0.001	0.1	0.1			
		4.5	-	0.36	0.44	V	*V _{IN} = V _{IL} or V _{IH} 24 mA I _{OL} 24 mA	
		5.5	-	0.36	0.44			
I _{IN}	Maximum Input Leakage Current	5.5	-	±0.1	±1.0	μA	V _I = V _{CC} , GND	
ΔI _{CCCT}	Additional Max. I _{CC} /Input	5.5	0.6	-	1.5	mA	V _I = V _{CC} - 2.1 V	
I _{OLD}	†Minimum Dynamic Output Current	5.5	-	-	75	mA	V _{OLD} = 1.65 V Max	
I _{OHD}		5.5	-	-	-75	mA	V _{OHD} = 3.85 V Min	
I _{CC}	Maximum Quiescent Supply Current	5.5	-	4.0	40	μA	V _{IN} = V _{CC} or GND	

*All outputs loaded; thresholds on input associated with output under test.

†Maximum test duration 2.0 ms, one output loaded at a time.

MC74AC32, MC74ACT32

AC CHARACTERISTICS (For Figures and Waveforms – See Section 3 of the ON Semiconductor FACT Data Book, DL138/D)

Symbol	Parameter	V _{CC} * (V)	74ACT			74ACT		Unit	Fig. No.
			T _A = +25°C C _L = 50 pF			T _A = -40°C to +85°C C _L = 50 pF			
			Min	Typ	Max	Min	Max		
t _{PLH}	Propagation Delay	5.0	1.0	–	9.0	1.0	10.0	ns	3–6
t _{PHL}	Propagation Delay	5.0	1.0	–	9.0	1.0	10.0	ns	3–6

*Voltage Range 5.0 V is 5.0 V ±0.5 V.

CAPACITANCE

Symbol	Parameter	Value Typ	Unit	Test Conditions
C _{IN}	Input Capacitance	4.5	pF	V _{CC} = 5.0 V
C _{PD}	Power Dissipation Capacitance	20	pF	V _{CC} = 5.0 V

MC74AC32, MC74ACT32

MARKING DIAGRAMS

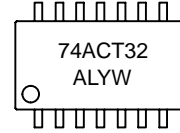
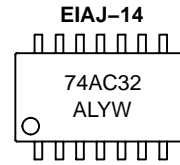
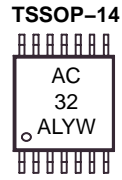
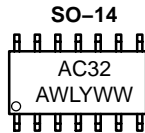
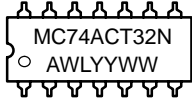
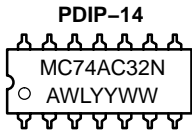

A = Assembly Location
WL, L = Wafer Lot
YY, Y = Year
WW, W = Work Week