



Frequency Generator for Multi-Processor Servers

Recommended Application:

ServerWorks Grand Champion Systems

Output Features:

- 8 - Differential CPU Clock Pairs @ 3.3V
- 1 - 3V 33MHz PCI clocks
- 1 - 48MHz clock
- 1 - Inverted 48MHz clock
- 1 - 14.318MHz reference output

Features:

- Up to 200MHz frequency support
- Support power management: Power Down Mode
- Supports Spread Spectrum modulation: 0 to -0.5% down spread.
- Uses external 14.318MHz crystal
- Select logic for Differential Swing Control, Test mode, Tristate, Power down, Spread Spectrum.
- External resistor for current reference
- FS pins for frequency select

Key Specifications:

- PCI Output jitter <500ps
- CPU Output jitter <150ps
- 48MHz Output jitter <350ps
- REF Output jitter < 1000ps

Pin Configuration

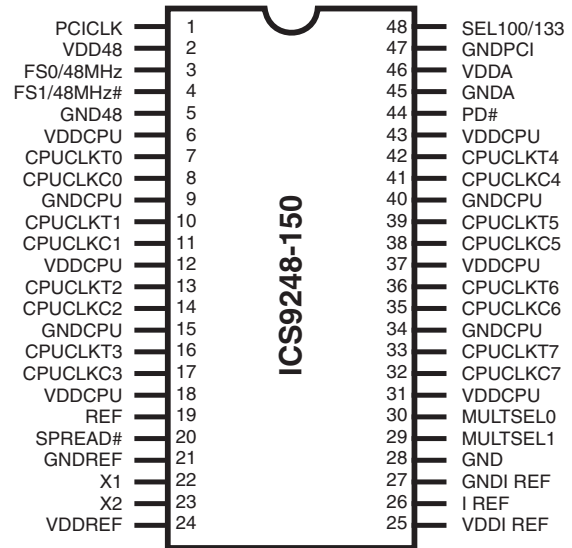

48-Pin SSOP and TSSOP

Functionality

SEL133/100	FS0	FS1	Function
0	0	0	Active 100MHz
0	0	1	100MHz Test Mode
0	1	0	100MHz Test Mode
0	1	1	Tristate all outputs
1	0	0	Active 133MHz
1	0	1	133MHz Test Mode
1	1	0	Active 200MHz
1	1	1	Reserved

Analog Power Groups

VDD48, GND48 = 48MHz, PLL2
VDDA=VDD (core supply voltage 3.3V)
GNDA=Ground for core supply

Digital Power Group

VDDREF, GNDREF = REF, Xtal

Block Diagram

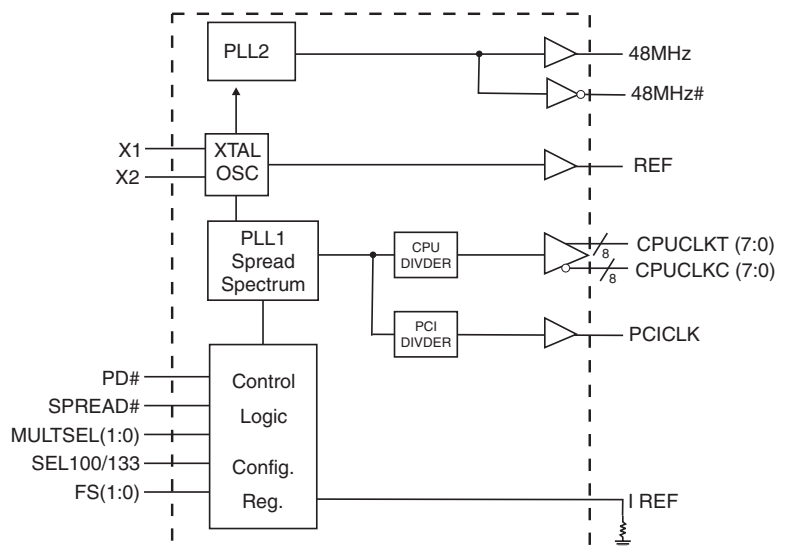



General Description

ICS9248-150 is a main clock for ServerWorks Grand Champion Systems. Spread spectrum typically reduces system EMI by 8dB to 10dB. This simplifies EMI qualification without resorting to board design iterations or costly shielding. ICS9248-150 employs a proprietary closed loop design, which tightly controls the percentage of spreading over process and temperature variations.

Pin Configuration

PIN NUMBER	PIN NAME	TYPE	DESCRIPTION
1	PCICLK	OUT	PCI clock output
2, 6, 12, 18, 24, 31, 37, 43,	VDD	PWR	3.3V power supply
3	FS0	IN	Frequency select pin
	48MHz	OUT	48MHz clock output
4	FS1	IN	Frequency select pin
	48MHz#	OUT	Inverted 48MHz clock output
5, 9, 15, 21, 28, 34, 40, 47	GND	PWR	Ground pins for 3.3V supply
33, 36, 39, 42, 16, 13, 10, 7	CPUCLKT (7:0)	OUT	"True" clocks of differential pair CPU outputs. These are current outputs and external resistors are required for voltage bias.
32, 35, 38, 41, 17, 14, 11, 8	CPUCLKC (7:0)	OUT	"Complementary" clocks of differential pair CPU outputs. These are current outputs and external resistors are required for voltage bias.
19	REF	OUT	Reference output 14.318MHz
20	SPREAD#	IN	Invokes Spread Spectrum functionality on the Differential host clocks, Active Low
22	X1	X2 Crystal Input	14.318MHz Crystal input
23	X2	X1 Crystal Output	14.318MHz Crystal output
25, 46	VDDI REF VDDA,	PWR	Analog power supply 3.3V
26	I REF	OUT	This pin establishes the reference current for the CPUCLK pairs. This pin takes a fixed precision resistor tied to ground in order to establish the required current.
29, 30	MULTSEL(1:0)	IN	CPU swing select inputs
44	PD#	IN	Invokes power-down mode. Active Low.
27, 45	GNDI REF GNDA	PWR	Analog Ground pins for 3.3V supply
48	SEL100/133	IN	CPU Frequency Select. Low=100MHz, High=133MHz



Truth Table

SEL 133/100	FS0	FS1	CPUCLK MHz	PCICLK MHz	48 MHz
0	0	0	100	33	48
0	0	1	100	33	Disable
0	1	0	100	Disable	Disable
0	1	1	Tristate	Tristate	Tristate
1	0	0	133	33	48
1	0	1	133	33	Disable
1	1	0	200	33	48
1	1	1	TCLK/2	TCLK/8	TCLK/2

CPUCLK Buffer Configuration

	Conditions	Configuration	Load	Min	Max
Iout	Vdd = nominal (3.30V)	All combinations of M0, M1 and Rr shown in table below	Nominal test load for given configuration	-7% I nominal	+7% I nominal
Iout	Vdd = 3.30 ± 5%	All combinations of M0, M1 and Rr shown in table below	Nominal test load for given configuration	-12% I nominal	+12% I nominal



CPUCLK Swing Select Functions

MULTSEL0	MULTSEL1	Board Target Trace/Term Z	Reference R, $I_{ref} = V_{dd}/(3 \cdot R_r)$	Output Current	Voh @ Z, $I_{ref} = 2.32\text{mA}$
0	0	60 ohms	$R_r = 475 \cdot 1\%$ $I_{ref} = 2.32\text{mA}$	$I_{oh} = 5 \cdot I_{ref}$	0.71V @ 60
0	0	50 ohms	$R_r = 475 \cdot 1\%$ $I_{ref} = 2.32\text{mA}$	$I_{oh} = 5 \cdot I_{ref}$	0.59V @ 50
0	1	60 ohms	$R_r = 475 \cdot 1\%$ $I_{ref} = 2.32\text{mA}$	$I_{oh} = 6 \cdot I_{ref}$	0.85V /2 60
0	1	50 ohms	$R_r = 475 \cdot 1\%$ $I_{ref} = 2.32\text{mA}$	$I_{oh} = 6 \cdot I_{ref}$	0.71V @ 50
1	0	60 ohms	$R_r = 475 \cdot 1\%$ $I_{ref} = 2.32\text{mA}$	$I_{oh} = 4 \cdot I_{ref}$	0.56V @ 60
1	0	50 ohms	$R_r = 475 \cdot 1\%$ $I_{ref} = 2.32\text{mA}$	$I_{oh} = 4 \cdot I_{ref}$	0.47V @ 50
1	1	60 ohms	$R_r = 475 \cdot 1\%$ $I_{ref} = 2.32\text{mA}$	$I_{oh} = 7 \cdot I_{ref}$	0.99V @ 60
1	1	50 ohms	$R_r = 475 \cdot 1\%$ $I_{ref} = 2.32\text{mA}$	$I_{oh} = 7 \cdot I_{ref}$	0.82V @ 50
<hr/>					
0	0	30 (DC equiv)	$R_r = 221 \cdot 1\%$ $I_{ref} = 5\text{mA}$	$I_{oh} = 5 \cdot I_{ref}$	0.75V @ 30
0	0	25 (DC equiv)	$R_r = 221 \cdot 1\%$ $I_{ref} = 5\text{mA}$	$I_{oh} = 5 \cdot I_{ref}$	0.62V @ 20
0	1	30 (DC equiv)	$R_r = 221 \cdot 1\%$ $I_{ref} = 5\text{mA}$	$I_{oh} = 6 \cdot I_{ref}$	0.90V @ 30
0	1	25 (DC equiv)	$R_r = 221 \cdot 1\%$ $I_{ref} = 5\text{mA}$	$I_{oh} = 6 \cdot I_{ref}$	0.75V @ 20
1	0	30 (DC equiv)	$R_r = 221 \cdot 1\%$ $I_{ref} = 5\text{mA}$	$I_{oh} = 4 \cdot I_{ref}$	0.60 @ 20
1	0	25 (DC equiv)	$R_r = 221 \cdot 1\%$ $I_{ref} = 5\text{mA}$	$I_{oh} = 4 \cdot I_{ref}$	0.5V @ 20
1	1	30 (DC equiv)	$R_r = 221 \cdot 1\%$ $I_{ref} = 5\text{mA}$	$I_{oh} = 7 \cdot I_{ref}$	1.05V @ 30
1	1	25 (DC equiv)	$R_r = 221 \cdot 1\%$ $I_{ref} = 5\text{mA}$	$I_{oh} = 7 \cdot I_{ref}$	0.84V @ 20



Absolute Maximum Ratings

Supply Voltage	5.5 V
Logic Inputs	GND -0.5 V to V _{DD} +0.5 V
Ambient Operating Temperature	0°C to +70°C
Case Temperature	115°C
Storage Temperature	-65°C to +150°C

Stresses above those listed under *Absolute Maximum Ratings* may cause permanent damage to the device. These ratings are stress specifications only and functional operation of the device at these or any other conditions above those listed in the operational sections of the specifications is not implied. Exposure to absolute maximum rating conditions for extended periods may affect product reliability.

Electrical Characteristics - Input/Supply/Common Output Parameters

T_A = 0 - 70°C; Supply Voltage V_{DD} = 3.3 V +/-5%

PARAMETER	SYMBOL	CONDITIONS	MIN	TYP	MAX	UNITS
Input High Voltage	V _{IH}		2		V _{DD} + 0.3	V
Input Low Voltage	V _{IL}		V _{SS} - 0.3		0.8	V
Input High Current	I _{IH}	V _{IN} = V _{DD}	-5		5	mA
Input Low Current	I _{IL1}	V _{IN} = 0 V; Inputs with no pull-up resistors	-5			mA
	I _{IL2}	V _{IN} = 0 V; Inputs with pull-up resistors	-200			
Operating Supply Current	I _{DD3.3OP}	C _L = 0 pF; Select @ 100 MHz		181	250	mA
Powerdown Current	I _{DD3.3PD}	C _L = 0 pF; Input address to VDD or GND		52	60	mA
Input Frequency	F _i	V _{DD} = 3.3 V		14.318		MHz
Pin Inductance	L _{pin}				7	nH
Input Capacitance ¹	C _{IN}	Logic Inputs			5	pF
	C _{OUT}	Output pin capacitance			6	pF
	C _{INX}	X1 & X2 pins	27		45	pF
Clk Stabilization ^{1, 2}	T _{STAB}	CPU Freq. = 100/133 MHz			8	ms
		CPU Freq. = 200 MHz			10.5	ms
Clk Recovery ^{1, 3}	T _{REC}	CPU Freq. = 100/133 MHz			8	ms
		CPU Freq. = 200 MHz			10.5	ms
Delay ¹	t _{PZH} , t _{PZL}	Output enable delay (all outputs)	1		10	ns
	t _{PHZ} , t _{PLZ}	Output disable delay (all outputs)	1		10	ns

¹Guaranteed by design, not 100% tested in production.

²From VDD = 3.3V to 1% of target frequency

³From deassertion of PD# to 1% of target frequency



Electrical Characteristics - CPU

$T_A = 0 - 70^\circ\text{C}$; $V_{DD} = 3.3\text{V} \pm 5\%$; $C_L = 10\text{-}20\text{ pF}$ (unless otherwise specified)

PARAMETER	SYMBOL	CONDITIONS	MIN	TYP	MAX	UNITS	NOTES
Current Source Output Impedance	Z_o^1	$V_O = V_x$	3000			Ω	1
Voltage High	VHigh	Statistical measurement on single ended signal using oscilloscope math function.	660	770	850	mV	1
Voltage Low	VLow		-150	5	150		1
Max Voltage	Vovs	Measurement on single ended signal using absolute value.		756	1150	mV	1
Min Voltage	Vuds		-300	-7			1
Rise Time	t_{r2B}^1	$V_{OL} = 20\%$, $V_{OH} = 80\%$	175	324	700	ps	1
Fall Time	t_{f2B}^1	$V_{OH} = 80\%$, $V_{OL} = 20\%$	175	501	700	ps	1
Diff. Crossover Voltage	V_x	$V_{DD} = 3.3\text{V}$	45	50	55	%	1
Duty Cycle	d_{t2B}^1	$V_T = 50\%$	45	51.2	55	%	1
Skew CPU0:7	t_{sk2B}^1	$V_T = 50\%$		83.8	100	ps	1
Skew CPU C0:7	t_{sk2B}^1	$V_T = 50\%$		78.5	100	ps	1
Jitter	$t_{jyc-cyc}^1$	$V_T = 50\%$		86	150	ps	1

¹Guaranteed by design, not 100% tested in production.

² I_{OVT} can be varied and is selectable thru the MULTSEL pin.

Electrical Characteristics - REF

$T_A = 0 - 70^\circ\text{C}$; $V_{DD} = 3.3\text{V} \pm 5\%$; $C_L = 10\text{-}20\text{ pF}$ (unless otherwise specified)

PARAMETER	SYMBOL	CONDITIONS	MIN	TYP	MAX	UNITS
Output Frequency	F_{O1}			14.318		MHz
Output Impedance	R_{DSP1}^1	$V_O = V_{DD} \cdot (0.5)$	20	48	60	Ω
Output High Voltage	V_{OH}^1	$I_{OH} = -1\text{ mA}$	2.4			V
Output Low Voltage	V_{OL}^1	$I_{OL} = 1\text{ mA}$			0.4	V
Output High Current	I_{OH}^1	$V_{OH@MIN} = 1.0\text{ V}$, $V_{OH@MAX} = 3.135\text{ V}$	-29		-23	mA
Output Low Current	I_{OL}^1	$V_{OL@MIN} = 1.95\text{ V}$, $V_{OL@MAX} = 0.4\text{ V}$	29		27	mA
Rise Time	t_{r1}^1	$V_{OL} = 0.4\text{ V}$, $V_{OH} = 2.4\text{ V}$	1	1.6	4	ns
Fall Time	t_{f1}^1	$V_{OH} = 2.4\text{ V}$, $V_{OL} = 0.4\text{ V}$	1	2.4	4	ns
Duty Cycle	d_{t1}^1	$V_T = 1.5\text{ V}$	45	53.5	55	%
Skew	t_{sk1}^1	$V_T = 1.5\text{ V}$			N/A	ps
Jitter	$t_{jyc-cyc}^1$	$V_T = 1.5\text{ V}$		305	1000	ps

¹Guaranteed by design, not 100% tested in production.



Electrical Characteristics - PCI

T_A = 0 - 70°C; VDD=3.3V +/-5%; C_L = 10-30 pF (unless otherwise specified)

PARAMETER	SYMBOL	CONDITIONS	MIN	TYP	MAX	UNITS
Output Frequency	F _{O1}			33.3		MHz
Output Impedance	R _{DSP1} ¹	V _O = V _{DD} *(0.5)	12	33	55	Ω
Output High Voltage	V _{OH} ¹	I _{OH} = -1 mA	2.4			V
Output Low Voltage	V _{OL} ¹	I _{OL} = 1 mA			0.55	V
Output High Current	I _{OH} ¹	V _{OH@MIN} = 1.0 V, V _{OH@MAX} = 3.135 V	-33		-33	mA
Output Low Current	I _{OL} ¹	V _{OL@MIN} = 1.95 V, V _{OL@MAX} = 0.4 V	30		38	mA
Rise Time	t _{r1} ¹	V _{OL} = 0.4 V, V _{OH} = 2.4 V	0.5	1.2	2	ns
Fall Time	t _{f1} ¹	V _{OH} = 2.4 V, V _{OL} = 0.4 V	0.5	1.2	2	ns
Duty Cycle	d _{t1} ¹	V _T = 1.5 V	45	49.9	55	%
Skew	t _{sk1} ¹	V _T = 1.5 V			N/A	ps
Jitter	t _{jycyc-cyc} ¹	V _T = 1.5 V		139.7	500	ps

¹Guaranteed by design, not 100% tested in production.

Electrical Characteristics - 48MHz

T_A = 0 - 70°C; VDD=3.3V +/-5%; C_L = 10-20 pF (unless otherwise specified)

PARAMETER	SYMBOL	CONDITIONS	MIN	TYP	MAX	UNITS
Output Frequency	F _{O1}			48		MHz
Output Impedance	R _{DSP1} ¹	V _O = V _{DD} *(0.5)	20	48	60	Ω
Output High Voltage	V _{OH} ¹	I _{OH} = -1 mA	2.4			V
Output Low Voltage	V _{OL} ¹	I _{OL} = 1 mA			0.4	V
Output High Current	I _{OH} ¹	V _{OH@MIN} = 1.0 V, V _{OH@MAX} = 3.135 V	-29		-23	mA
Output Low Current	I _{OL} ¹	V _{OL@MIN} = 1.95 V, V _{OL@MAX} = 0.4 V	29		27	mA
Rise Time	t _{r1} ¹	V _{OL} = 0.4 V, V _{OH} = 2.4 V	1	1.3	4	ns
Fall Time	t _{f1} ¹	V _{OH} = 2.4 V, V _{OL} = 0.4 V	1	1.6	4	ns
Duty Cycle	d _{t1} ¹	V _T = 1.5 V	45	52.5	55	%
Skew	t _{sk1} ¹	V _T = 1.5 V			N/A	ps
Jitter	t _{jycyc-cyc} ¹	V _T = 1.5 V		175	350	ps

¹Guaranteed by design, not 100% tested in production.



PD# Timing Diagram

The power down selection is used to put the part into a very low power state without turning off the power to the part. PD# is an asynchronous active low input. This signal needs to be synchronized internal to the device prior to powering down the clock synthesizer.

Internal clocks are not running after the device is put in power down. When PD# is active low all clocks need to be driven to a low value and held prior to turning off the VCOs and crystal. The power down latency should be as short as possible but conforming to the sequence requirements shown below.

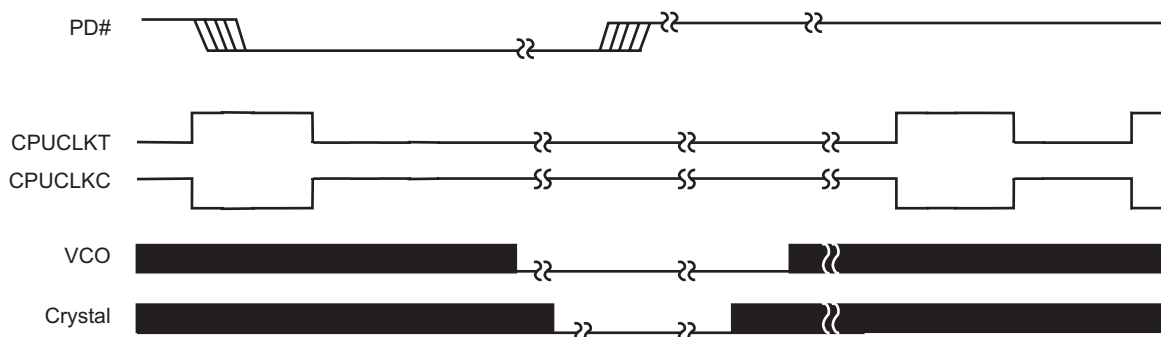

Notes:

1. As shown, the outputs Stop Low on the next falling edge after PD# goes low.
2. PD# is an asynchronous input and metastable conditions may exist. This signal is synchronized inside this part.
3. The shaded sections on the VCO and the Crystal signals indicate an active clock.

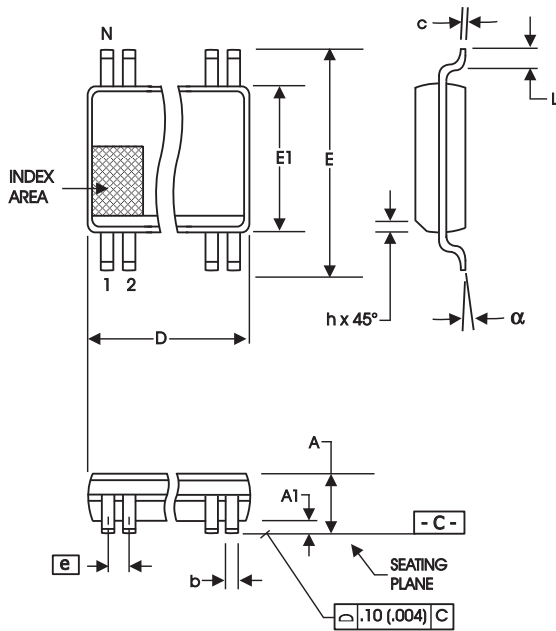

300 mil SSOP Package

SYMBOL	In Millimeters COMMON DIMENSIONS		In Inches COMMON DIMENSIONS	
	MIN	MAX	MIN	MAX
A	2.41	2.80	.095	.110
A1	0.20	0.40	.008	.016
b	0.20	0.34	.008	.0135
c	0.13	0.25	.005	.010
D	SEE VARIATIONS		SEE VARIATIONS	
E	10.03	10.68	.395	.420
E1	7.40	7.60	.291	.299
e	0.635 BASIC		0.025 BASIC	
h	0.38	0.64	.015	.025
L	0.50	1.02	.020	.040
N	SEE VARIATIONS		SEE VARIATIONS	
α	0°	8°	0°	8°

N	VARIATIONS			
	D mm.		D (inch)	
	MIN	MAX	MIN	MAX
48	15.75	16.00	.620	.630

Reference Doc.: JEDEC Publication 95, MO-118

10-0034

Ordering Information

ICS9248yF-150-T

Example:

ICS XXXX y F - PPP - T

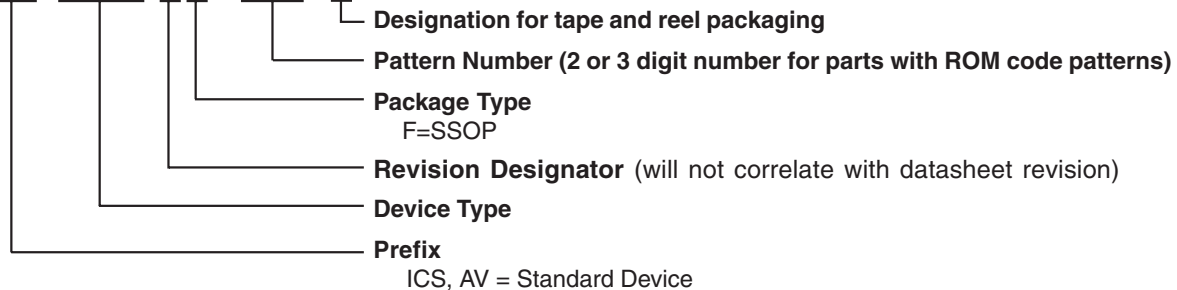

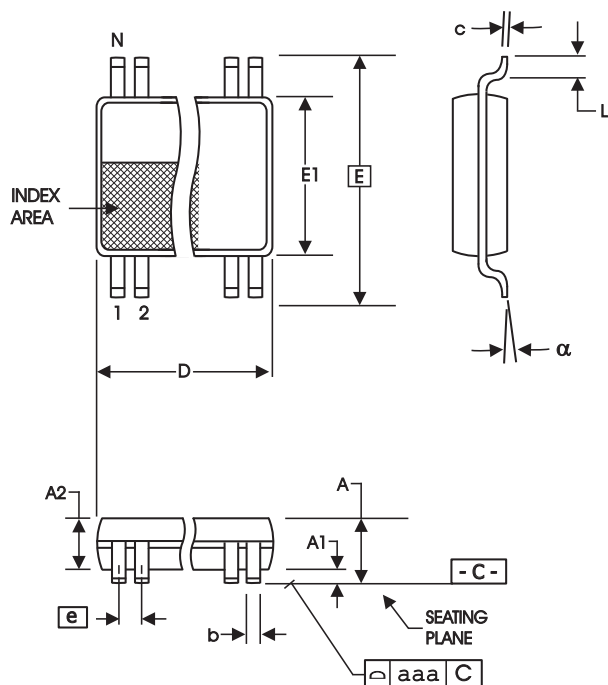

SYMBOL	In Millimeters COMMON DIMENSIONS		In Inches COMMON DIMENSIONS	
	MIN	MAX	MIN	MAX
A	--	1.20	--	.047
A1	0.05	0.15	.002	.006
A2	0.80	1.05	.032	.041
b	0.17	0.27	.007	.011
c	0.09	0.20	.0035	.008
D	SEE VARIATIONS		SEE VARIATIONS	
E	8.10 BASIC		0.319 BASIC	
E1	6.00	6.20	.236	.244
e	0.50 BASIC		0.020 BASIC	
L	0.45	0.75	.018	.030
N	SEE VARIATIONS		SEE VARIATIONS	
α	0°	8°	0°	8°
aaa	--	0.10	--	.004

VARIATIONS

N	D mm.		D (inch)	
	MIN	MAX	MIN	MAX
48	12.40	12.60	.488	.496

Reference Doc.: JEDEC Publication 95, MO-153

10-0039

6.10 mm. Body, 0.50 mm. pitch TSSOP
(240 mil) (0.020 mil)

Ordering Information

ICS9248yG-150-T

Example:

ICS XXXX y G - PPP - T

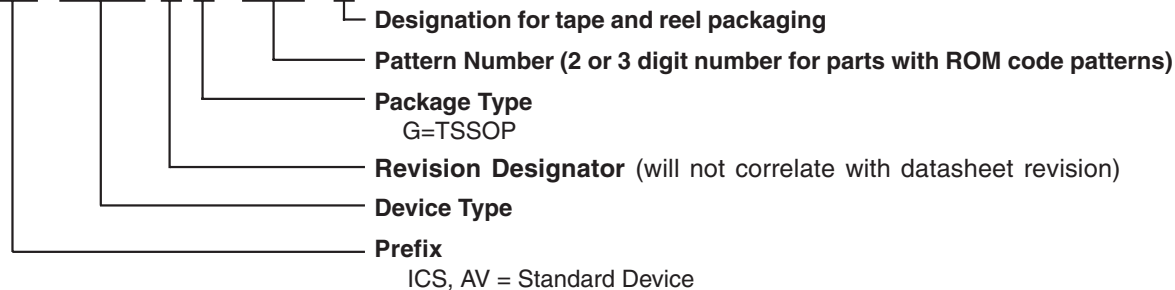



Revision History

Rev.	Issue Date	Description	Page #
E	6/9/2005	Removed PCI Skew from Electrical Characteristics Table.	7
F	3/29/2006	Updated Electrical Characteristics CPU Table.	6