



MTA 100

TE Internal #: 3-644083-2

Standard Rectangular Connectors, Connector Assembly, Receptacle, Mating Alignment, Polarization Mating Alignment Type, Mating Retention, MTA 100

[View on TE.com >](#)

Connectors > Rectangular Connectors > Standard Rectangular Connectors > Nylon Tin Plated Receptacle: 2.54 mm, with Mating Alignment, MTA 100

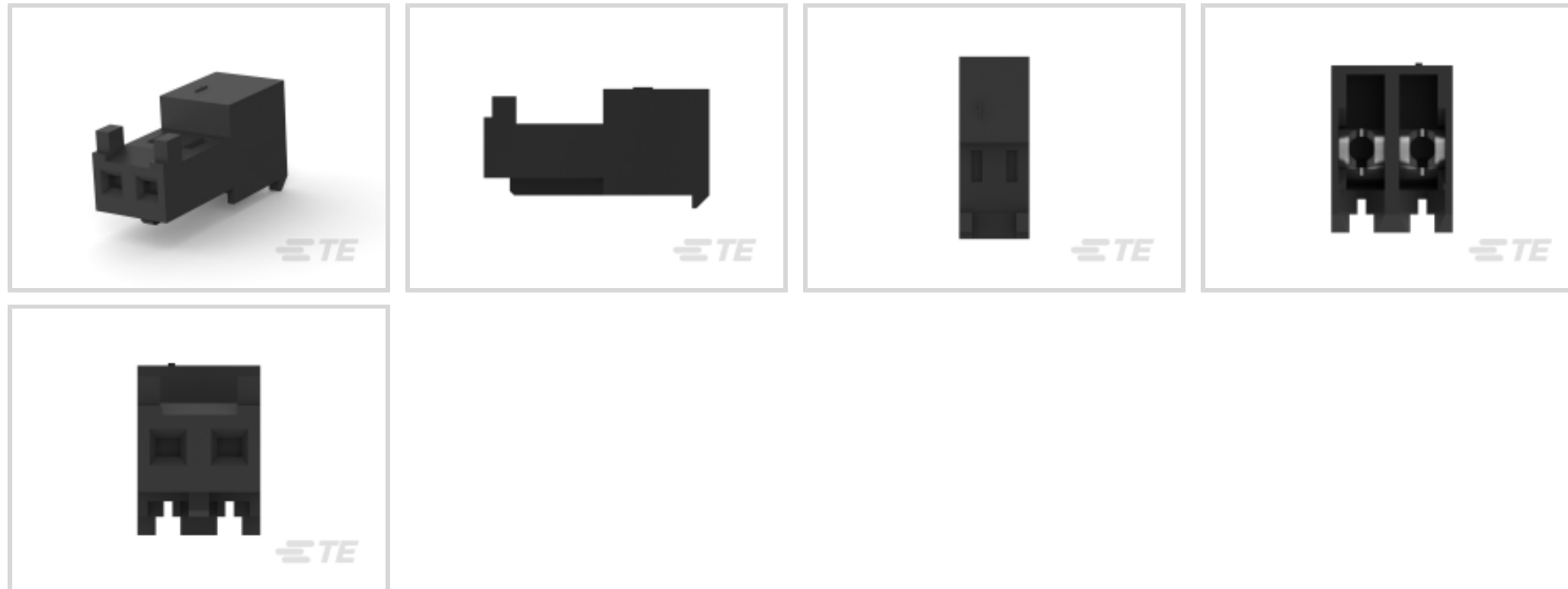

Connector Product Type: **Connector Assembly**

Connector & Housing Type: **Receptacle**

Mating Alignment: **With**

Mating Alignment Type: **Polarization**

Mating Retention: **With**

[All Nylon Tin Plated Receptacle: 2.54 mm, with Mating Alignment, MTA 100 \(127\)](#)

## Features

### Product Type Features

Compatible With Discrete Wire Type	Stranded
Connector Product Type	Connector Assembly
Connector & Housing Type	Receptacle
Connector System	Wire-to-Board
Insertion Force Type	Normal
Sealable	No
Connector & Contact Terminates To	Wire & Cable

### Configuration Features

Number of Cavities	2
Contacts Preloaded	Yes
Number of Positions	2
Number of Rows	1



### Electrical Characteristics

Operating Voltage	250 VAC
-------------------	---------

### Contact Features

Contact Type	Receptacle
Wire Contact Termination Area Plating Material	Tin
Contact Underplating Material	Nickel
Contact Mating Area Plating Material	Tin
Contact Retention Within Housing	With
Contact Current Rating (Max)	5 A

### Termination Features

Termination Method to Wire & Cable	Insulation Displacement (IDC)
------------------------------------	-------------------------------

### Mechanical Attachment

Contact Retention Type Within Housing	Locking Lance
Mating Alignment	With
Mating Alignment Type	Polarization
Mating Retention	With
Mating Retention Type	Locking Ramp
Connector Mounting Type	Cable Mount (Free-Hanging)

### Housing Features

Housing Material	Nylon
Housing Color	Black
Centerline (Pitch)	2.54 mm[.1 in]

### Dimensions

Compatible Insulation Diameter (Max)	1.52 mm[.06 in]
Connector Height	13.21 mm[.52 in]
Product Width	6.99 mm[.275 in]
Product Length	5.08 mm[.2 in]
Wire Size	.3 – .4 mm <sup>2</sup>

### Usage Conditions

Operating Temperature Range	-55 – 105 °C[-67 – 221 °F]
-----------------------------	----------------------------

### Operation/Application

Shielded	No
----------	----



## Circuit Application

## Signal

## Industry Standards

CSA Rating	LR 7189
UL Rating	Recognized
Agency/Standard	CSA, UL
Approved Standards	UL E28476
UL Flammability Rating	UL 94V-0

## Packaging Features

Packaging Quantity	500
Packaging Method	Bag/Box

## Product Compliance

For compliance documentation, visit the product page on [TE.com](https://www.te.com)>

EU RoHS Directive 2011/65/EU	Compliant
EU ELV Directive 2000/53/EC	Compliant
China RoHS 2 Directive MIIT Order No 32, 2016	No Restricted Materials Above Threshold
EU REACH Regulation (EC) No. 1907/2006	Current ECHA Candidate List: JUNE 2023 (235) Candidate List Declared Against: JUNE 2023 (235) Does not contain REACH SVHC
Halogen Content	Low Halogen - Br, Cl, F, I < 900 ppm per homogenous material. Also BFR/CFR/PVC Free
Solder Process Capability	Not applicable for solder process capability

## Product Compliance Disclaimer

This information is provided based on reasonable inquiry of our suppliers and represents our current actual knowledge based on the information they provided. This information is subject to change. The part numbers that TE has identified as EU RoHS compliant have a maximum concentration of 0.1% by weight in homogenous materials for lead, hexavalent chromium, mercury, PBB, PBDE, DBP, BBP, DEHP, DIBP, and 0.01% for cadmium, or qualify for an exemption to these limits as defined in the Annexes of Directive 2011/65/EU (RoHS2). Finished electrical and electronic equipment products will be CE marked as required by Directive 2011/65/EU. Components may not be CE marked. Additionally, the part numbers that TE has identified as EU ELV compliant have a maximum concentration of 0.1% by weight in homogenous materials for lead, hexavalent chromium, and mercury, and 0.01% for cadmium, or qualify for an exemption to these limits as defined in the Annexes of Directive 2000/53/EC (ELV). Regarding the REACH Regulation, the information TE provides on SVHC in articles for this part number is based on the latest European Chemicals Agency (ECHA) 'Guidance on requirements for substances in articles' posted at this URL: <https://echa.europa.eu/guidance-documents/guidance-on-reach>

## Compatible Parts



TE Part # CAT-104MTA-PRUMH  
PCB Header: Polyester, Right Angle, 2.54 mm



TE Part # CAT-104MTA-PVBRH  
Polyester Vertical PCB Header: 2.54 mm, Breakaway, MTA 100



TE Part # CAT-104MTA-PVUNH  
PCB Header: Polyester, Vertical, Unshrouded, No Mating Alignment



TE Part # CAT-104MTA-PRSMH  
PCB Header, Right Angle, Polyester, 2.54 mm



TE Part # 640454-2  
02P MTA100 HDR ASSY SQ STR POL



TE Part # CAT-104MTA-PRUSH  
PCB Header: Polyester, Right Angle, Unshrouded



TE Part # 640550-2  
02P MTA100 COVER



TE Part # CAT-104MTA-PVSHH  
Polyester Vertical PCB Header: 2.54 mm, Shrouded, MTA 100



TE Part # CAT-104MTA-NYLCC  
Nylon PCB Connector Covers: 2.54 mm, MTA 100



TE Part # CAT-104MTA-NVTHH  
Nylong Vertical PCB Header: 2.54mm, Through Hole, MTA 100



TE Part # 58074-1  
MTA 50/100/156 MANUAL TOOL FRAME



TE Part # 3-647106-2  
02P MTA-100 HDR ASSY,SM,SN



TE Part # 3-644694-2  
02P MTA100 R/A HDR RETENTIVE



TE Part # 3-647051-2  
02P MTA100 HRD ASSYF/L HT LF



TE Part # 58246-3  
MTA 100 CRIMP HEAD PRODUCTION RBBN CABLE



TE Part # 58579-1  
MTA 100 MANUAL TOOL ASSEMBLY DISCRETE



TE Part # 58039-1  
MTA 100 ARBOR FIXTURE DISCRETE RBN CABLE



TE Part # 58246-2  
MTA 100 CRIMP HEAD PRODUCTION DISCRETE

Also in the Series | **MTA 100**

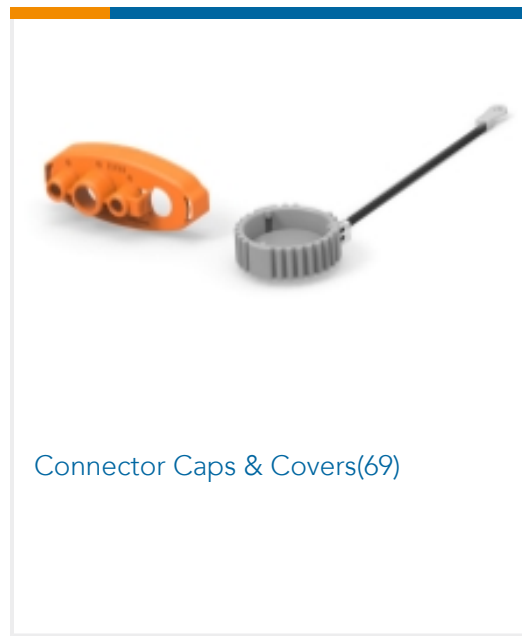

Connector Caps & Covers(69)

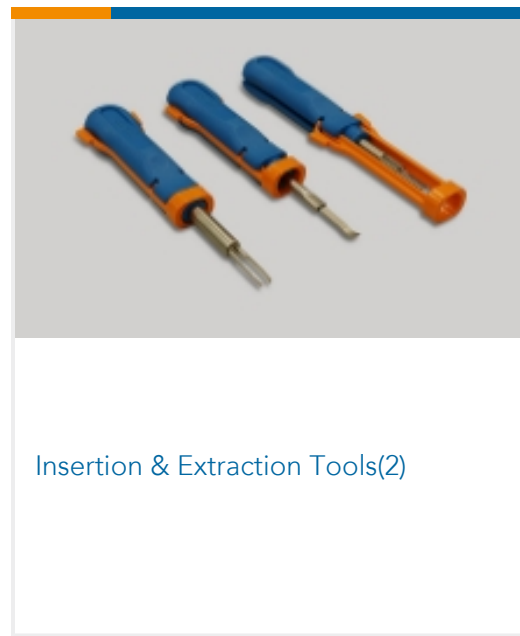

Insertion & Extraction Tools(2)

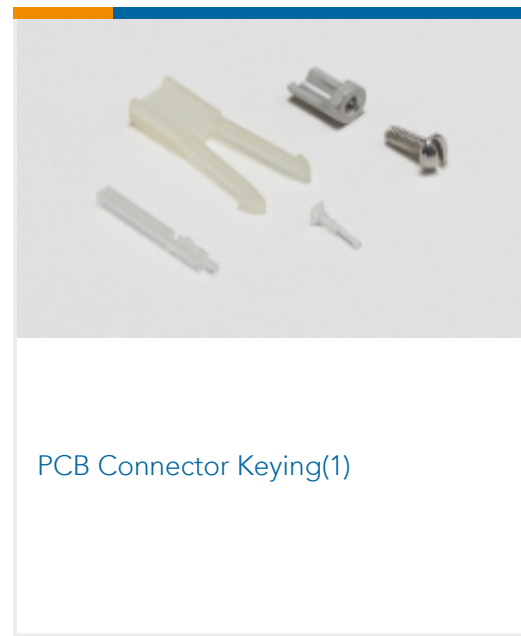

PCB Connector Keying(1)



PCB Headers & Receptacles(440)

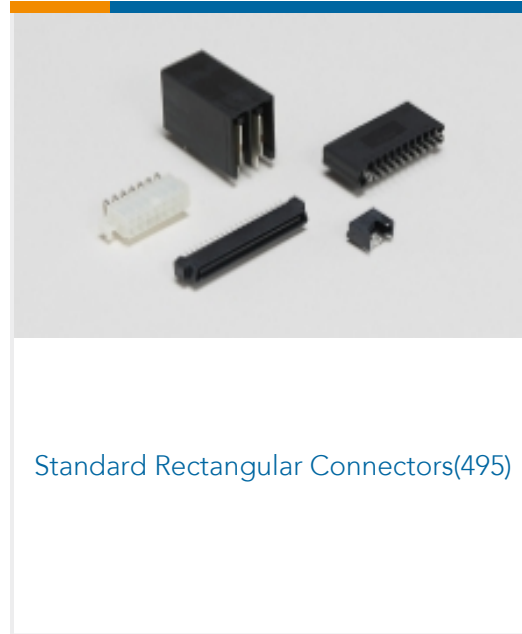

Standard Rectangular Connectors(495)

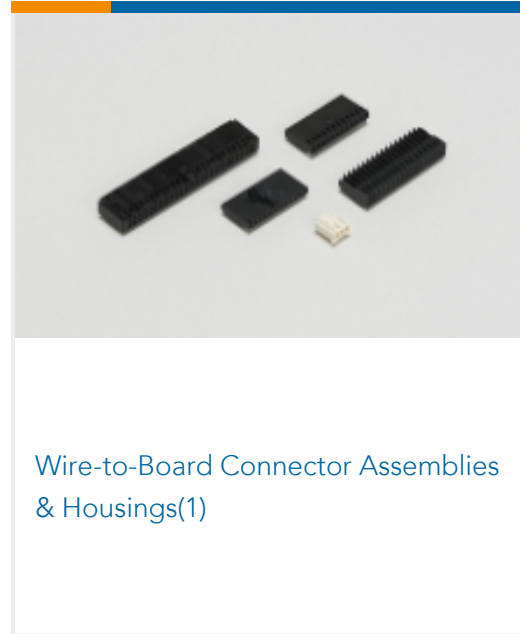

Wire-to-Board Connector Assemblies & Housings(1)

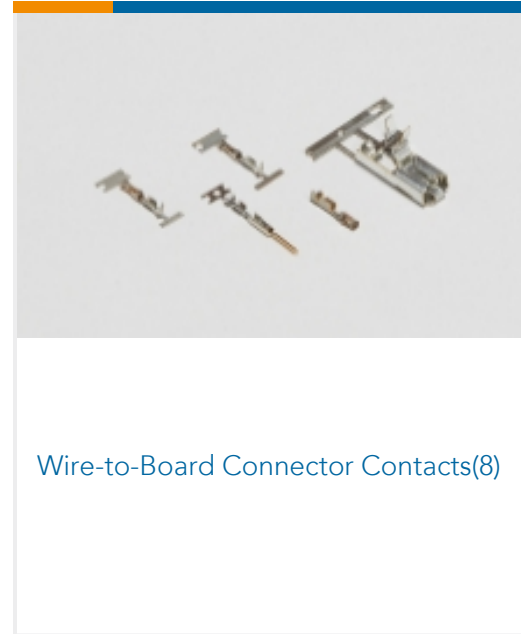

Wire-to-Board Connector Contacts(8)

## Customers Also Bought



TE Part #640909-1  
RECEPT,PIDG FASTON 22-18 205



TE Part #1-6609006-7  
15EEJ1=F8021 S0



TE Part #3-643813-7  
07P MTA100 CONN ASSY POL RIB

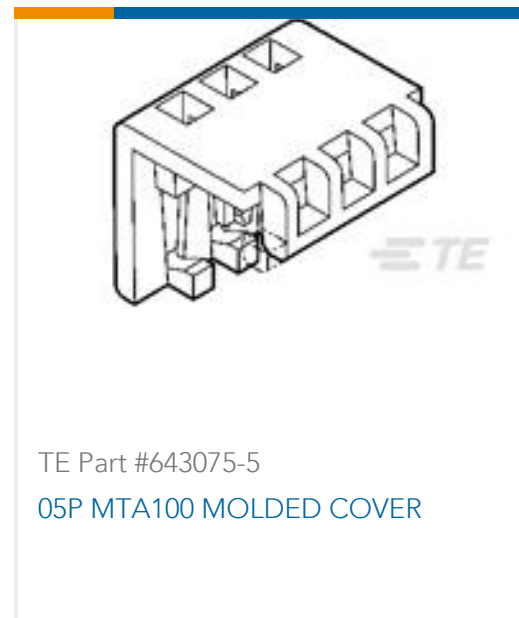

TE Part #643075-5  
05P MTA100 MOLDED COVER



TE Part #52124-1  
TERMINAL, PIDG, R 26-22 10



TE Part #1487594-2  
USB, A-B, 28/28, BLACK, 0.25M



TE Part #7-1393246-5  
W23-X1A1G-5=W23/W31-



TE Part #1-329492-1  
LOCK WASHER COAXICON



TE Part #2041376-2  
RJ45 W LED 2X2,30u",DIP,H=25.4mm



TE Part #750644-1  
50SR SCREWLOCK KIT,FEMALE

## Documents



**Product Drawings**

**02P MTA100 CONN ASSY POL TAB**

English

---

**CAD Files**

**Customer View Model**

**ENG\_CVM\_3-644083-2\_H.3d\_stp.zip**

English

**Customer View Model**

**ENG\_CVM\_3-644083-2\_H.2d\_dxf.zip**

English

**3D PDF**

English

**Customer View Model**

**ENG\_CVM\_3-644083-2\_H.3d\_igs.zip**

English

By downloading the CAD file I accept and agree to the [Terms and Conditions](#) of use.

---

**Product Specifications**

**Application Specification**

English

---

**Product Environmental Compliance**

**TE Material Declaration**

English

---

**Agency Approvals**

**Agency Approval Document**

English