

QUAD DIFFERENTIAL COMPARATOR

The KA239 series consists of four independent voltage comparators designed to operate from single power supply over a wide voltage range.

FEATURES

- Single or dual supply operation
- Wide range of supply voltage KA239/A, KA339/A: 2 ~ 36V
 KA2901 (or $\pm 1 \sim \pm 18V$)
 KA3302: 2 ~ 28V
 (or $\pm 1 \sim \pm 1.4V$)
- Low supply current drain 800 μA Typ
- Open collector outputs for wired and connectors
- Low input bias current 25nA Typ
- Low Input offset current $\pm 2.3nA$ Typ.
- Low input offset voltage $\pm 1.4mV$ Typ.
- Common mode input voltage range includes ground.
- Low output saturation voltage
- Output compatible with TTL, DTL and MOS logic system

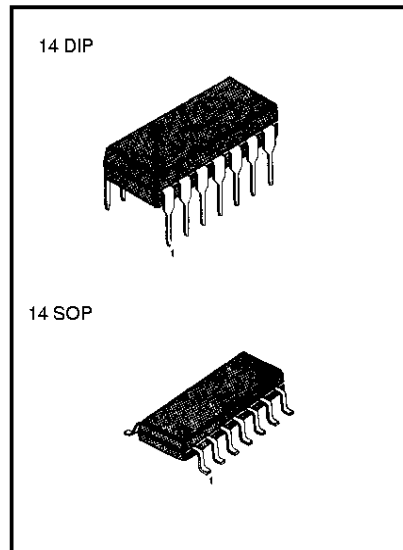

BLOCK DIAGRAM

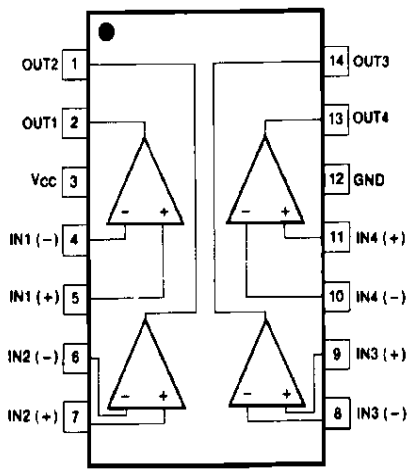

ORDERING INFORMATION

Device	Package	Operating Temperature
KA339 KA339A	14 DIP	0 ~ +70 °C
KA339D KA339AD	14 SOP	
KA239 KA239A	14 DIP	-25 ~ +85 °C
KA239D KA239AD	14 SOP	
KA2901 KA2901D	14 DIP 14 SOP	-40 ~ +85 °C
KA3302	14 DIP	
KA3302D	14 SOP	

SCHEMATIC DIAGRAM

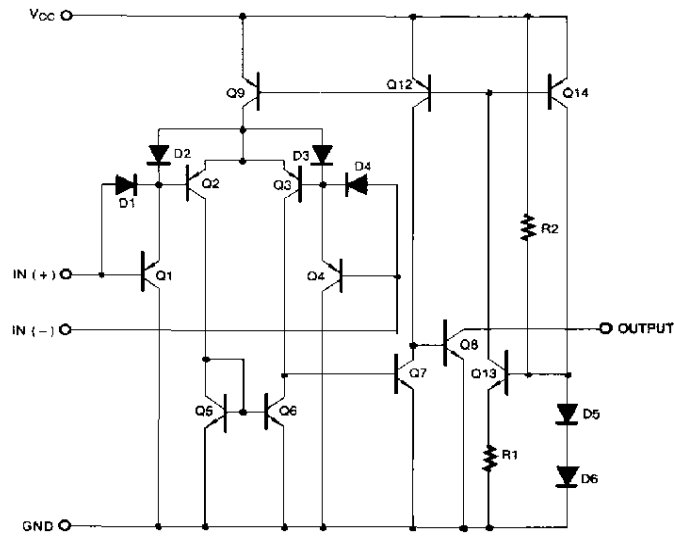

ABSOLUTE MAXIMUM RATINGS

Characteristic	Symbol	Value	Unit
Supply Voltage	V_{CC}	± 18 or 36	V
Supply Voltage Only KA3302	V_{CC}	± 14 or 28	V
Differential Input Voltage	$V_{I(DIFF)}$	36	V
Differential Input Voltage Only KA3302	$V_{I(DIFF)}$	28	V
Input Voltage	V_I	-0.3 to $+36$	V
Input Voltage Only KA3302	V_I	-0.3 to $+28$	V
Output Short Circuit to GND		Continuous	
Power Dissipation	P_D	570	mW
Operating Temperature KA339/KA339A	T_{OPR}	$0 \sim +70$	$^{\circ}C$
KA239/KA239A	T_{OPR}	$-25 \sim +85$	$^{\circ}C$
KA2901/KA3302	T_{OPR}	$-40 \sim +85$	$^{\circ}C$
Storage Temperature	T_{STG}	$-65 \sim +150$	$^{\circ}C$

ELECTRICAL CHARACTERISTICS

(V_{CC} = 5V, T_A = 25°C, unless otherwise specified)

Characteristic	Symbol	Test Conditions	KA239A/KA339A			KA239/KA339			Unit
			Min	Typ	Max	Min	Typ	Max	
Input Offset Voltage	V _{IO}	V _{CM} = 0V to V _{CC} = 1.5V		± 1	± 2		± 1.4	± 5	mV
		V _{O(P)} = 1.4V, R _S = 0Ω	NOTE 1		± 4.0		± 9.0		
Input Offset Current	I _{IO}			± 2.3	± 50		± 2.3	± 50	nA
		NOTE 1			± 150		± 150		
Input Bias Current	I _{BIAS}			57	250		57	250	nA
		NOTE 1			400		400		
Input Common Mode Voltage Range	V _{I(R)}		0	V _{CC} -1.5	0	V _{CC} -1.5			V
		NOTE 1	0	V _{CC} -2	0	V _{CC} -2			
Supply Current	I _{CC}	R _L = ∞		1.1	2.0		1.1	2.0	mA
Voltage Gain	G _V	V _{CC} = 15V, R _L ≥ 15KΩ (for large swing)	50	200		50	200	V/mV	
Large Signal Response Time	t _{RES}	V _I = TTL Logic Swing V _{REF} = 1.4V, V _{RL} = 5V, R _L = 5.1KΩ		350		350		ns	
Response Time	t _{RES}	V _{RL} = 5V, R _L = 5.1KΩ		1.4		1.4		μs	
Output Sink Current	I _{SINK}	V _{I(+)} ≥ 1V, V _{I(-)} = 0V, V _{O(P)} ≤ 1.5V	6	18		6	18	mA	
Output Saturation Voltage	V _{SAT}	V _{I(+)} ≥ 1V, V _{I(-)} = 0V		140	400		140	400	mV
		I _{SINK} = 4mA	NOTE 1		700		700		
Output Leakage Current	I _{O(LKG)}	V _{I(+)} = 0V	V _{O(P)} = 5V	0.1		0.1		nA	
		V _{I(+)} = 1V	V _{O(P)} = 30V		1.0		1.0	μA	
Differential Voltage	V _{I(DIFF)}		NOTE 1		36		36	V	

Note 1.

KA339/A: 0 ≤ T_A ≤ +70°CKA239/A: -25 ≤ T_A ≤ +85°CKA2901/3302: -40 ≤ T_A ≤ +85°C

ELECTRICAL CHARACTERISTICS

(V_{CC} = 5V, T_A = 25°C, unless otherwise specified)

Characteristic	Symbol	Test Conditions	KA2901			KA3302			Unit
			Min	Typ	Max	Min	Typ	Max	
Input Offset Voltage	V _{IO}	V _{CM} = 0V to V _{CC} = 1.5V V _{O(P)} = 1.4V, R _S = 0Ω		2	7		2	20	mV
			NOTE 1	9	15		40		
Input Offset Current	I _{IO}			2.3	50		3	100	nA
			NOTE 1	50	200		300		
Input Bias Current	I _{BIAS}			57	250		57	250	nA
			NOTE 1	200	500		1000		
Input Common Mode Voltage Range	V _{I(R)}			0	V _{CC} -1.5		0	V _{CC} -1.5	V
			NOTE 1	0	V _{CC} -2		0	V _{CC} -2	
Supply Current	I _{CC}			R _L = ∞	1.1	2.0	1.1	2.0	mA
				R _L = ∞, V _{CC} = 30V	1.6	2.5			
Voltage Gain	G _V	V _{CC} = 15V, R _L ≥ 15KΩ (for large swing)	25	100		2	30	V/mV	
Large Signal Response Time	t _{RES}	V _I = TTL Logic Swing V _{REF} = 1.4V, V _{RL} = 5V, R _L = 5.1KΩ		350			350	ns	
Response Time	t _{RES}	V _{RL} = 5V, R _L = 5.1KΩ		1.4			1.4	μs	
Output Sink Current	I _{SINK}	V _{I(-)} ≥ 1V, V _{I(+)} = 0V, V _{O(P)} ≤ 1.5V	6	18		6	18	mA	
Output Saturation Voltage	V _{SAT}	V _{I(-)} ≥ 1V, V _{I(+)} = 0V I _{SINK} = 4mA		140	400		140	400	mV
			NOTE 1		700		700		
Output Leakage Current	I _{O(LKG)}	V _{I(-)} = 0V V _{I(+)} = 1V		V _{O(P)} = 5V	0.1		0.1	nA	
				V _{O(P)} = 30V		1.0		1.0	μA
Differential Voltage	V _{I(DIFF)}				36		36	V	

Note 1.

KA339/A: 0 ≤ T_A ≤ +70°CKA239/A: -25 ≤ T_A ≤ +85°CKA2901/3302: -40 ≤ T_A ≤ +85°C

TYPICAL PERFORMANCE CHARACTERISTICS

Fig. 1 SUPPLY CURRENT

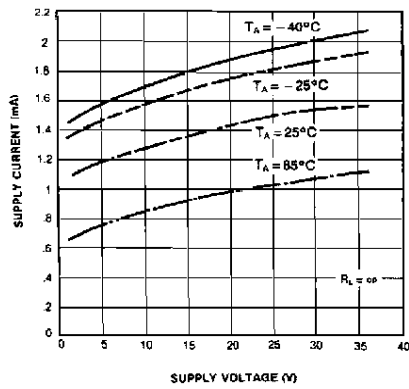

Fig. 2 INPUT CURRENT

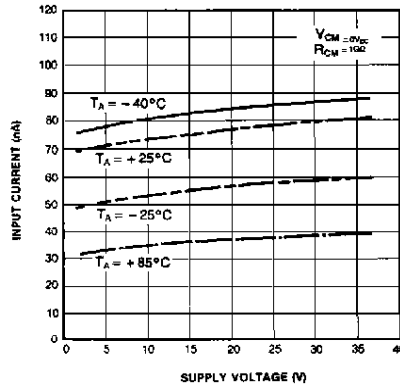

Fig. 3 OUTPUT SATURATION VOLTAGE

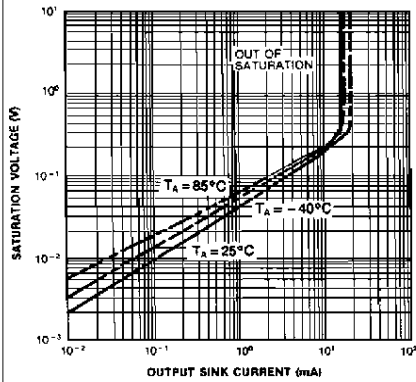

Fig. 4 RESPONSE TIME FOR VARIOUS INPUT OVERDRIVE-NEGATIVE TRANSITION

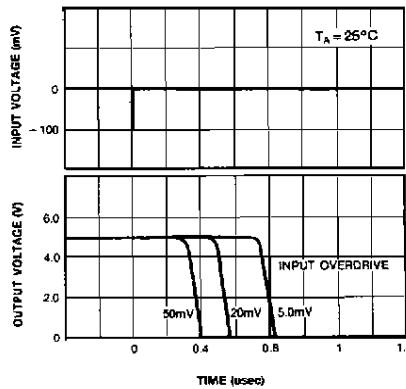
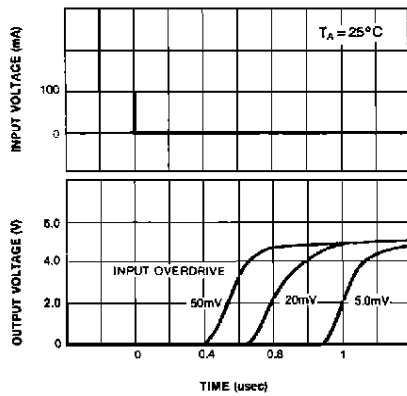

Fig. 5 RESPONSE TIME FOR VARIOUS INPUT OVERDRIVE-POSITIVE TRANSITION



KA239/A, KA339/A, KA2901, KA3302

QUAD COMPARATOR

