

AT-32011, AT-32033

Low Current, High Performance NPN Silicon Bipolar Transistor



Data Sheet

Description

Avago's AT-32011 and AT-32033 are high performance NPN bipolar transistors that have been optimized for maximum f_t at low voltage operation, making them ideal for use in battery powered applications in wireless markets. The AT-32033 uses the 3 lead SOT-23, while the AT-32011 places the same die in the higher performance 4 lead SOT-143. Both packages are industry standard, and compatible with high volume surface mount assembly techniques.

The 3.2 micron emitter-to-emitter pitch and reduced parasitic design of these transistors yields extremely high performance products that can perform a multiplicity of tasks. The 20 emitter finger interdigitated geometry yields an easy to match to and extremely fast transistor with moderate power, low noise resistance, and low operating currents.

Optimized performance at 2.7 V makes these devices ideal for use in 900 MHz, 1.8 GHz, and 2.4 GHz battery operated systems as an LNA, gain stage, buffer, oscillator, or active mixer. Typical amplifier designs at 900 MHz yield 1.2 dB noise figures with 12 dB or more associated gain at a 2.7 V, 2 mA bias, with noise performance being relatively insensitive to input match. High gain capability at 1 V, 1 mA makes these devices a good fit for 900 MHz pager applications. Voltage breakdowns are high enough for use at 5 volts.

The AT-3 series bipolar transistors are fabricated using an optimized version of Avago's 10 GHz f_t , 30 GHz f_{MAX} Self-Aligned-Transistor (SAT) process. The die are nitride passivated for surface protection. Excellent device uniformity, performance and reliability are produced by the use of ion-implantation, self-alignment techniques, and gold metalization in the fabrication of these devices.

Features

- High Performance Bipolar Transistor Optimized for Low Current, Low Voltage Operation
- 900 MHz Performance:
 - AT-32011: 1 dB NF, 14 dB G_A
 - AT-32033: 1 dB NF, 12.5 dB G_A
- Characterized for End-Of-Life Battery Use (2.7 V)
- SOT-23 and SOT-143 SMT Plastic Packages
- Tape-And-Reel Packaging Option Available
- Lead-free Option Available

Outline Drawing

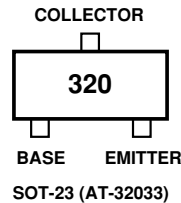
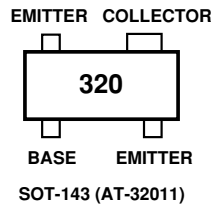

AT-32011, AT-32033 Absolute Maximum Ratings

Symbol	Parameter	Units	Absolute Maximum ^[1]
V_{EBO}	Emitter-Base Voltage	V	1.5
V_{CBO}	Collector-Base Voltage	V	11
V_{CEO}	Collector-Emitter Voltage	V	5.5
I_C	Collector Current	mA	32
P_T	Power Dissipation ^[2, 3]	mW	200
T_j	Junction Temperature	°C	150
T_{STG}	Storage Temperature	°C	-65 to 150

Thermal Resistance^{[2]:}

$$\theta_{jc} = 550 \text{ } ^\circ\text{C/W}$$

Notes:

1. Operation of this device above any one of these parameters may cause permanent damage.
2. $T_{\text{Mounting Surface}} = 25^\circ\text{C}$.
3. Derate at $1.82 \text{ mW}/^\circ\text{C}$ for $T_C > 40^\circ\text{C}$.

Electrical Specifications, $T_A = 25^\circ\text{C}$

Symbol	Parameters and Test Conditions	Units	AT-32011			AT-32033		
			Min.	Typ.	Max.	Min.	Typ.	Max.
NF	Noise Figure $V_{CE} = 2.7 \text{ V}, I_C = 2 \text{ mA}$ $f = 0.9 \text{ GHz}$	dB		1.0 ^[1]	1.3 ^[1]		1.0 ^[2]	1.3 ^[2]
G_A	Associated Gain $V_{CE} = 2.7 \text{ V}, I_C = 2 \text{ mA}$ $f = 0.9 \text{ GHz}$	dB	12.5 ^[1]	14 ^[1]		11 ^[2]	12.5 ^[2]	
h_{FE}	Forward Current Transfer Ratio $V_{CE} = 2.7 \text{ V}, I_C = 2 \text{ mA}$	-	70		300	70		300
I_{CBO}	Collector Cutoff Current $V_{CB} = 3 \text{ V}$	μA			0.2			0.2
I_{EBO}	Emitter Cutoff Current $V_{EB} = 1 \text{ V}$	μA			1.5			1.5

Notes:

1. Test circuit A, Figure 1. Numbers reflect device performance de-embedded from circuit losses. Input loss = 0.3 dB; output loss = 0.3 dB.
2. Test circuit B, Figure 1. Numbers reflect device performance de-embedded from circuit losses. Input loss = 0.3 dB; output loss = 0.3 dB.

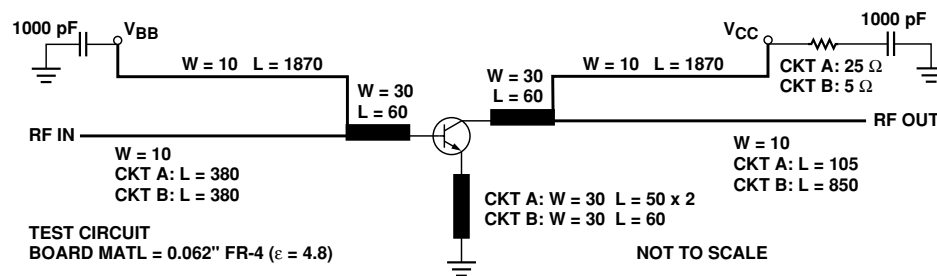

DIMENSIONS IN MILS

Figure 1. Test Circuit for Noise Figure and Associated Gain.

This circuit is a compromise match between best noise figure, best gain, stability, and a practical synthesizable match.

Characterization Information, $T_A = 25^\circ\text{C}$

Symbol	Parameters and Test Conditions	Units	AT-32011	AT-32033
			Typ.	Typ.
P_{1dB}	Power at 1 dB Gain Compression (opt tuning) $V_{CE} = 2.7\text{ V}$, $I_C = 20\text{ mA}$ $f = 0.9\text{ GHz}$	dBm	13	13
G_{1dB}	Gain at 1 dB Gain Compression (opt tuning) $V_{CE} = 2.7\text{ V}$, $I_C = 20\text{ mA}$ $f = 0.9\text{ GHz}$	dB	16.5	15
IP_3	Output Third Order Intercept Point (opt tuning) $V_{CE} = 2.7\text{ V}$, $I_C = 20\text{ mA}$ $f = 0.9\text{ GHz}$	dBm	24	24
$ S_{21} _E^2$	Gain in $50\ \Omega$ System $V_{CE} = 2.7\text{ V}$, $I_C = 2\text{ mA}$ $f = 0.9\text{ GHz}$	dB	13	11.5

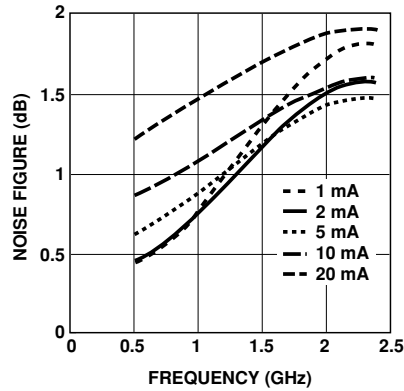

Figure 2. AT-32011 and AT-32033 Minimum Noise Figure vs. Frequency and Current at $V_{CE} = 2.7\text{ V}$.

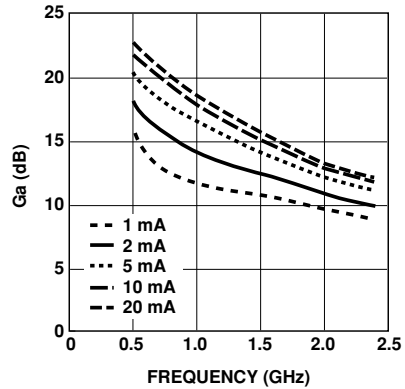

Figure 3. AT-32011 Associated Gain at Optimum Noise Match vs. Frequency and Current at $V_{CE} = 2.7\text{ V}$.

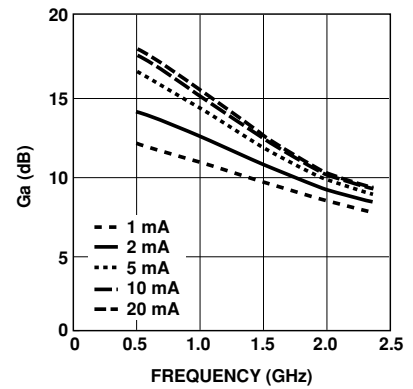

Figure 4. AT-32033 Associated Gain at Optimum Noise Match vs. Frequency and Current at $V_{CE} = 2.7\text{ V}$.

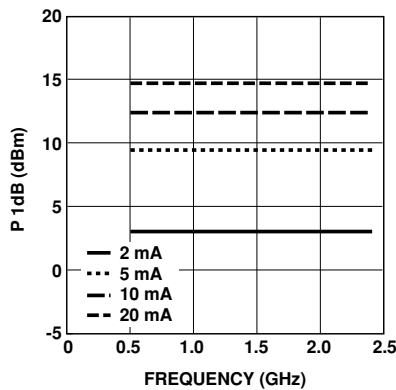

Figure 5. AT-32011 and AT-32033 Power at 1 dB Gain Compression vs. Frequency and Current at $V_{CE} = 2.7\text{ V}$.

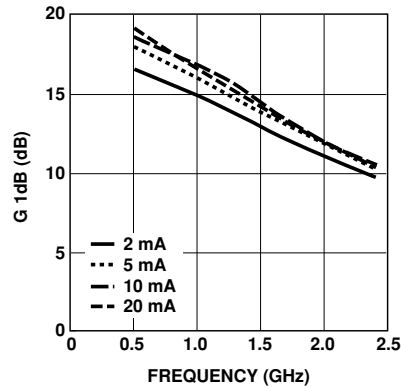

Figure 6. AT-32011 1 dB Compressed Gain vs. Frequency and Current at $V_{CE} = 2.7\text{ V}$.

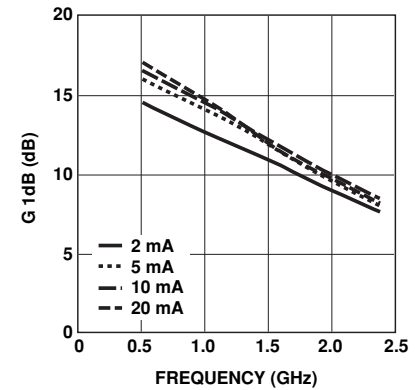

Figure 7. AT-32033 1 dB Compressed Gain vs. Frequency and Current at $V_{CE} = 2.7\text{ V}$.

AT-32011, AT-32033 Typical Performance

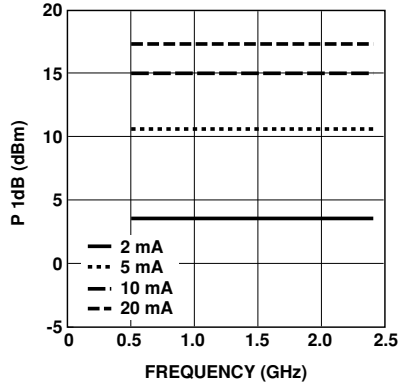

Figure 8. AT-32011 and AT-32033 Power at 1 dB Gain Compression vs. Frequency and Current at $V_{CE} = 5$ V.

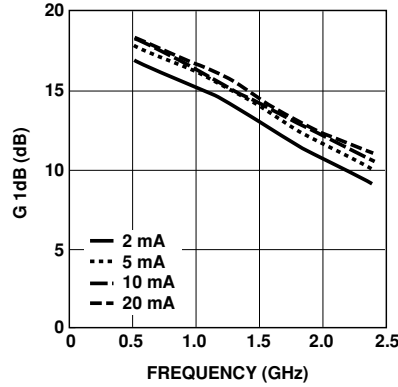

Figure 9. AT-32011 1 dB Compressed Gain vs. Frequency and Current at $V_{CE} = 5$ V.

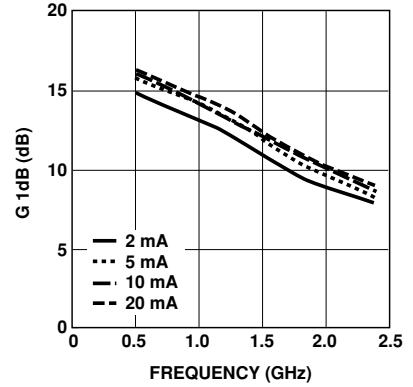

Figure 10. AT-32033 1 dB Compressed Gain vs. Frequency and Current at $V_{CE} = 5$ V.

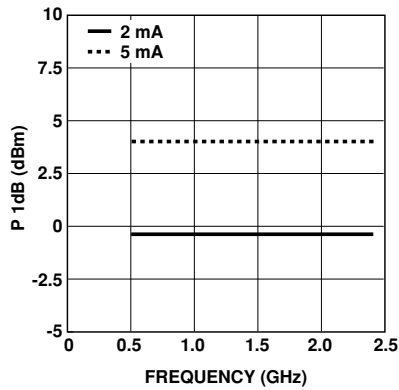

Figure 11. AT-32011 and AT-32033 Power at 1 dB Gain Compression vs. Frequency and Current at $V_{CE} = 1$ V.

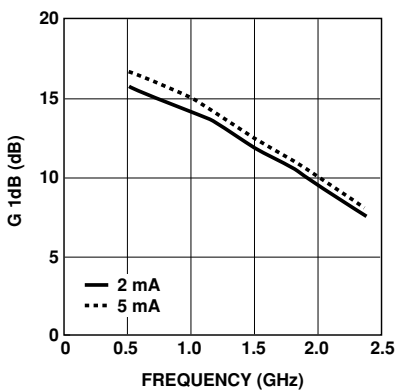

Figure 12. AT-32011 1 dB Compressed Gain vs. Frequency and Current at $V_{CE} = 1$ V.

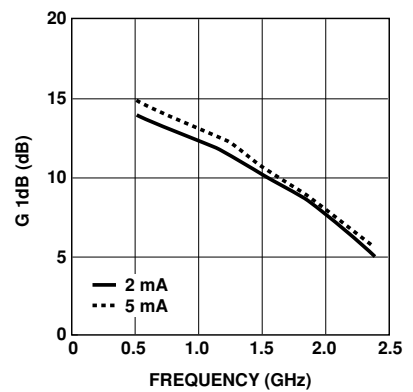

Figure 13. AT-32033 1 dB Compressed Gain vs. Frequency and Current at $V_{CE} = 1$ V.

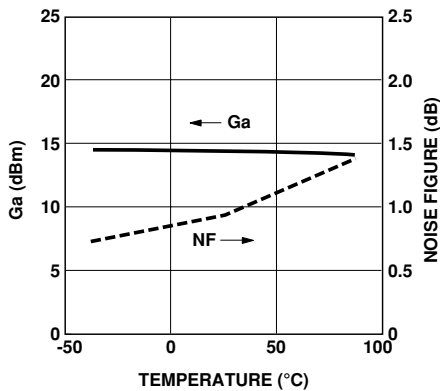

Figure 14. AT-32011 Noise Figure and Associated Gain at $V_{CE} = 2.7$ V, $I_C = 2$ mA vs. Temperature in Test Circuit, Figure 1. (Circuit Losses De-embedded).

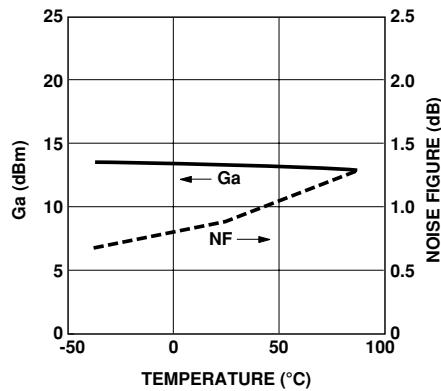

Figure 15. AT-32033 Noise Figure and Associated Gain at $V_{CE} = 2.7$ V, $I_C = 2$ mA vs. Temperature in Test Circuit, Figure 1. (Circuit Losses De-embedded).

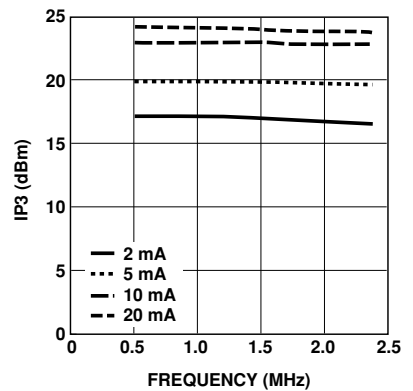

Figure 16. AT-32011 and AT-32033 Third Order Intercept vs. Frequency and Bias at $V_{CE} = 2.7$ V, with Optimal Tuning.

AT-32011 Typical Scattering Parameters, Common Emitter, $Z_o = 50 \Omega$ $V_{CE} = 1 \text{ V}$, $I_C = 1 \text{ mA}$

Freq. GHz	S_{11}		S_{21}			S_{12}			S_{22}	
	Mag	Ang	dB	Mag	Ang	dB	Mag	Ang	Mag	Ang
0.1	0.97	-11	11.09	3.59	172	-33.55	0.021	83	0.99	-5
0.5	0.88	-52	10.13	3.21	141	-20.85	0.091	59	0.92	-21
0.9	0.78	-86	8.67	2.71	117	-17.62	0.132	41	0.82	-32
1.0	0.75	-94	8.35	2.62	112	-17.27	0.137	37	0.79	-35
1.5	0.67	-127	6.35	2.08	89	-16.30	0.153	23	0.71	-45
1.8	0.63	-144	5.25	1.83	77	-16.28	0.154	16	0.67	-50
2.0	0.61	-155	4.75	1.73	70	-16.42	0.151	13	0.65	-53
2.4	0.59	-175	3.48	1.49	57	-16.86	0.144	9	0.62	-59
3.0	0.59	157	1.77	1.23	40	-17.89	0.128	8	0.61	-68
4.0	0.63	120	-0.39	0.96	18	-18.40	0.120	23	0.59	-84
5.0	0.69	94	-2.39	0.76	0	-15.60	0.166	35	0.59	-104

AT-32011 Typical Noise Parameters, Common Emitter, $Z_o = 50 \Omega$, 1 V , $I_C = 1 \text{ mA}$

Freq. GHz	F_{min} dB	Γ_{opt}		R_n -
		Mag	Ang	
0.5 ^[1]	0.42	0.79	26	0.44
0.9	0.71	0.70	54	0.35
1.8	1.37	0.53	119	0.18
2.4	1.80	0.55	158	0.08

Note:

1. 0.5 GHz noise parameter values are extrapolated, not measured.

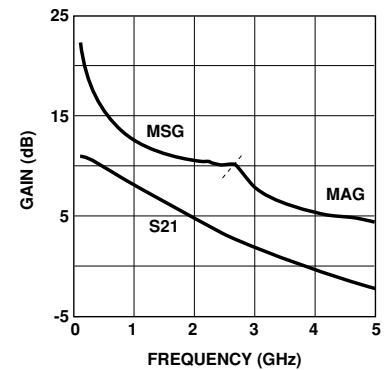

Figure 17. AT-32011 Gains vs. Frequency at $V_{CE} = 1 \text{ V}$, $I_C = 1 \text{ mA}$.

AT-32033 Typical Scattering Parameters, Common Emitter, $Z_o = 50 \Omega$ $V_{CE} = 1 \text{ V}$, $I_C = 1 \text{ mA}$

Freq. GHz	S_{11}		S_{21}			S_{12}			S_{22}	
	Mag	Ang	dB	Mag	Ang	dB	Mag	Ang	Mag	Ang
0.1	0.97	-11	11.09	3.58	170	-32.75	0.023	83	0.99	-5
0.5	0.81	-52	9.88	3.12	134	-20.30	0.097	60	0.90	-22
0.9	0.61	-87	8.07	2.53	107	-17.57	0.132	46	0.78	-33
1.0	0.56	-95	7.65	2.41	101	-17.24	0.137	44	0.76	-35
1.5	0.41	-136	5.43	1.87	77	-16.61	0.148	39	0.68	-42
1.8	0.36	-160	4.30	1.64	66	-16.36	0.152	41	0.65	-46
2.0	0.34	-177	3.74	1.54	59	-16.05	0.158	44	0.63	-49
2.4	0.34	154	2.49	1.33	47	-15.10	0.176	49	0.61	-55
3.0	0.38	119	0.96	1.12	32	-12.77	0.230	55	0.59	-65
4.0	0.46	81	-0.84	0.91	15	-8.68	0.368	50	0.56	-87
5.0	0.51	56	-1.90	0.80	5	-5.68	0.520	37	0.51	-114

AT-32033 Typical Noise Parameters, Common Emitter, $Z_o = 50 \Omega$, 1 V , $I_C = 1 \text{ mA}$

Freq. GHz	F_{min} dB	Γ_{opt}		R_n -
		Mag	Ang	
0.5 ^[1]	0.42	0.87	25	0.48
0.9	0.71	0.73	55	0.34
1.8	1.37	0.42	143	0.11
2.4	1.80	0.50	-162	0.07

Note:

1. 0.5 GHz noise parameter values are extrapolated, not measured.

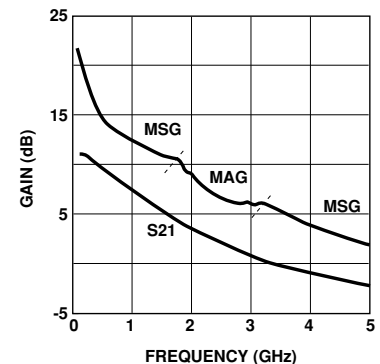

Figure 18. AT-32033 Gains vs. Frequency at $V_{CE} = 1 \text{ V}$, $I_C = 1 \text{ mA}$.

AT-32011 Typical Scattering Parameters, Common Emitter, $Z_o = 50 \Omega$ $V_{CE} = 2.7 \text{ V}$, $I_C = 2 \text{ mA}$

Freq. GHz	S_{11}		S_{21}			S_{12}			S_{22}	
	Mag	Ang	dB	Mag	Ang	dB	Mag	Ang	Mag	Ang
0.1	0.94	-13	16.67	6.81	170	-35.25	0.017	82	0.99	-6
0.5	0.80	-60	15.10	5.69	136	-23.07	0.070	57	0.86	-24
0.9	0.67	-97	12.97	4.45	112	-20.34	0.096	41	0.73	-35
1.0	0.64	-104	12.48	4.21	107	-20.05	0.099	39	0.70	-37
1.5	0.55	-137	10.04	3.18	86	-19.21	0.110	30	0.61	-45
1.8	0.51	-154	8.77	2.75	76	-19.04	0.112	28	0.58	-49
2.0	0.50	-165	8.13	2.55	70	-18.99	0.112	27	0.56	-52
2.4	0.48	176	6.75	2.18	58	-18.84	0.114	27	0.54	-57
3.0	0.49	150	4.97	1.77	43	-18.52	0.119	30	0.52	-64
4.0	0.54	116	2.73	1.37	22	-16.98	0.142	36	0.50	-77
5.0	0.61	92	0.83	1.10	4	-14.50	0.188	37	0.50	-95

AT-32011 Typical Noise Parameters,

 Common Emitter, $Z_o = 50 \Omega$, 2.7 V , $I_C = 2 \text{ mA}$

Freq. GHz	F_{min} dB	Γ_{opt}		R_n -
		Mag	Ang	
0.5 ^[1]	0.57	0.69	22	0.30
0.9	0.78	0.60	51	0.25
1.8	1.25	0.42	117	0.14
2.4	1.57	0.44	159	0.08

Note:

1. 0.5 GHz noise parameter values are extrapolated, not measured.

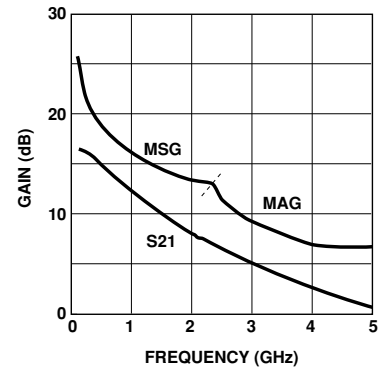
 Figure 19. AT-32011 Gains vs. Frequency at $V_{CE} = 2.7 \text{ V}$, $I_C = 2 \text{ mA}$.

AT-32033 Typical Scattering Parameters, Common Emitter, $Z_o = 50 \Omega$ $V_{CE} = 2.7 \text{ V}$, $I_C = 2 \text{ mA}$

Freq. GHz	S_{11}		S_{21}			S_{12}			S_{22}	
	Mag	Ang	dB	Mag	Ang	dB	Mag	Ang	Mag	Ang
0.1	0.93	-13	16.61	6.77	167	-34.89	0.018	82	0.99	-6
0.5	0.68	-56	14.29	5.18	127	-23.10	0.070	61	0.83	-22
0.9	0.44	-86	11.48	3.75	101	-20.35	0.096	55	0.71	-30
1.0	0.39	-93	10.88	3.50	96	-19.91	0.101	54	0.70	-31
1.5	0.23	-129	8.16	2.56	76	-17.99	0.126	55	0.64	-36
1.8	0.18	-156	6.89	2.21	66	-16.89	0.143	57	0.62	-39
2.0	0.16	-176	6.19	2.04	60	-16.14	0.156	57	0.61	-42
2.4	0.17	146	4.91	1.76	50	-14.70	0.184	58	0.60	-47
3.0	0.22	108	3.35	1.47	36	-12.51	0.237	57	0.58	-56
4.0	0.32	76	1.51	1.19	18	-9.19	0.347	51	0.55	-73
5.0	0.40	56	0.17	1.02	4	-6.54	0.471	40	0.51	-95

AT-32033 Typical Noise Parameters,

 Common Emitter, $Z_o = 50 \Omega$, 2.7 V , $I_C = 2 \text{ mA}$

Freq. GHz	F_{min} dB	Γ_{opt}		R_n -
		Mag	Ang	
0.5 ^[1]	0.57	0.77	15	0.36
0.9	0.78	0.63	49	0.28
1.8	1.25	0.32	136	0.10
2.4	1.57	0.40	-159	0.08

Note:

1. 0.5 GHz noise parameter values are extrapolated, not measured.

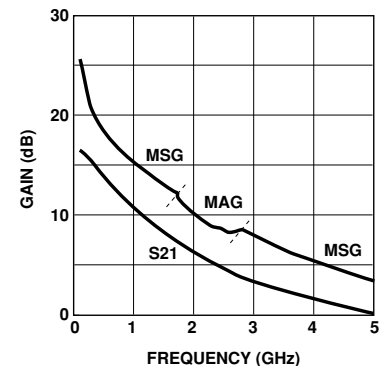
 Figure 20. AT-32033 Gains vs. Frequency at $V_{CE} = 2.7 \text{ V}$, $I_C = 2 \text{ mA}$.

AT-32011 Typical Scattering Parameters, Common Emitter, $Z_o = 50 \Omega$ $V_{CE} = 2.7 \text{ V}, I_C = 20 \text{ mA}$

Freq. GHz	S_{11}		S_{21}			S_{12}			S_{22}	
	Mag	Ang	dB	Mag	Ang	dB	Mag	Ang	Mag	Ang
0.1	0.52	-49	31.08	35.79	149	-37.78	0.013	72	0.83	-22
0.5	0.36	-138	22.96	14.06	102	-28.93	0.036	62	0.40	-42
0.9	0.34	-168	18.33	8.25	86	-25.15	0.055	64	0.31	-42
1.0	0.34	-174	17.46	7.47	83	-24.41	0.060	64	0.30	-42
1.5	0.34	165	14.13	5.09	71	-21.35	0.086	63	0.28	-45
1.8	0.34	155	12.61	4.27	64	-19.92	0.101	61	0.28	-49
2.0	0.35	148	11.74	3.86	60	-19.08	0.111	60	0.27	-52
2.4	0.36	136	10.23	3.25	52	-17.60	0.132	57	0.27	-58
3.0	0.39	120	8.38	2.62	40	-15.86	0.161	51	0.26	-67
4.0	0.45	98	6.00	2.00	23	-13.68	0.207	42	0.24	-84
5.0	0.52	82	4.25	1.63	7	-11.93	0.253	32	0.23	-106

AT-32011 Typical Noise Parameters,Common Emitter, $Z_o = 50 \Omega, 2.7 \text{ V}, I_C = 20 \text{ mA}$

Freq. GHz	F_{min} dB	Γ_{opt}		R_n -
		Mag	Ang	
0.5 ^[1]	1.39	0.15	65	0.16
0.9	1.51	0.14	105	0.13
1.8	1.78	0.28	-164	0.12
2.4	1.96	0.40	-142	0.13

Note:

1. 0.5 GHz noise parameter values are extrapolated, not measured.

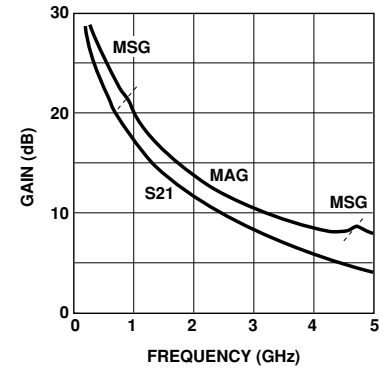
Figure 21. AT-32011 Gains vs. Frequency at $V_{CE} = 2.7 \text{ V}, I_C = 20 \text{ mA}$.**AT-32033 Typical Scattering Parameters, Common Emitter, $Z_o = 50 \Omega$** $V_{CE} = 2.7 \text{ V}, I_C = 20 \text{ mA}$

Freq. GHz	S_{11}		S_{21}			S_{12}			S_{22}	
	Mag	Ang	dB	Mag	Ang	dB	Mag	Ang	Mag	Ang
0.1	0.50	-35	29.84	31.03	137	-37.08	0.014	77	0.79	-18
0.5	0.16	-52	19.58	9.53	94	-25.35	0.054	77	0.53	-20
0.9	0.08	-36	14.81	5.50	81	-20.63	0.093	75	0.50	-24
1.0	0.07	-31	13.96	4.99	78	-19.66	0.104	74	0.50	-25
1.5	0.06	12	10.71	3.43	66	-16.31	0.153	69	0.49	-31
1.8	0.07	31	9.31	2.92	60	-14.75	0.183	66	0.48	-35
2.0	0.08	40	8.50	2.66	56	-13.85	0.203	63	0.47	-38
2.4	0.11	48	7.16	2.28	48	-12.32	0.242	59	0.46	-44
3.0	0.15	53	5.62	1.91	37	-10.49	0.299	52	0.43	-54
4.0	0.21	52	3.86	1.56	20	-8.11	0.393	41	0.39	-71
5.0	0.26	48	2.61	1.35	6	-6.34	0.482	29	0.33	-91

AT-32033 Typical Noise Parameters,Common Emitter, $Z_o = 50 \Omega, 2.7 \text{ V}, I_C = 20 \text{ mA}$

Freq. GHz	F_{min} dB	Γ_{opt}		R_n -
		Mag	Ang	
0.5 ^[1]	1.39	0.15	45	0.28
0.9	1.51	0.12	100	0.22
1.8	1.78	0.28	-135	0.14
2.4	1.96	0.46	-107	0.22

Note:

1. 0.5 GHz noise parameter values are extrapolated, not measured.

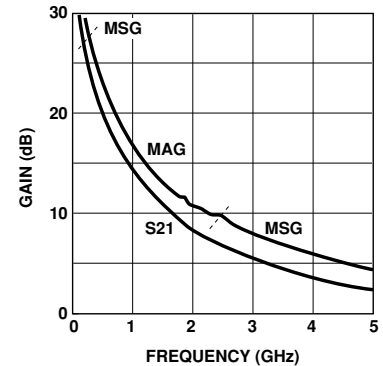
Figure 22. AT-32033 Gains vs. Frequency at $V_{CE} = 2.7 \text{ V}, I_C = 20 \text{ mA}$.

AT-32011 Typical Scattering Parameters, Common Emitter, $Z_o = 50 \Omega$ $V_{CE} = 5 \text{ V}, I_C = 2 \text{ mA}$

Freq. GHz	S_{11}		S_{21}			S_{12}			S_{22}	
	Mag	Ang	dB	Mag	Ang	dB	Mag	Ang	Mag	Ang
0.1	0.95	-13	16.65	6.80	170	-35.84	0.016	82	0.99	-6
0.5	0.81	-57	15.18	5.74	137	-23.56	0.066	58	0.87	-23
0.9	0.68	-93	13.16	4.55	113	-20.72	0.092	43	0.74	-34
1.0	0.64	-100	12.69	4.31	109	-20.42	0.095	40	0.72	-36
1.5	0.55	-133	10.31	3.28	88	-19.49	0.106	32	0.63	-43
1.8	0.51	-150	9.05	2.84	78	-19.29	0.109	29	0.60	-47
2.0	0.49	-161	8.43	2.64	71	-19.22	0.109	28	0.58	-50
2.4	0.47	180	7.06	2.25	60	-19.03	0.112	29	0.55	-55
3.0	0.47	153	5.29	1.84	45	-18.72	0.116	31	0.54	-62
4.0	0.52	118	3.07	1.42	24	-17.19	0.138	37	0.52	-75
5.0	0.59	94	1.17	1.14	6	-14.73	0.183	38	0.51	-92

AT-32011 Typical Noise Parameters,Common Emitter, $Z_o = 50 \Omega, 2.7 \text{ V}, I_C = 2 \text{ mA}$

Freq. GHz	F_{min} dB	Γ_{opt}		R_n -
		Mag	Ang	
0.5 ^[1]	0.52	0.73	20	0.34
0.9	0.75	0.63	49	0.28
1.8	1.26	0.44	111	0.16
2.4	1.60	0.45	153	0.09

Note:

1. 0.5 GHz noise parameter values are extrapolated, not measured.

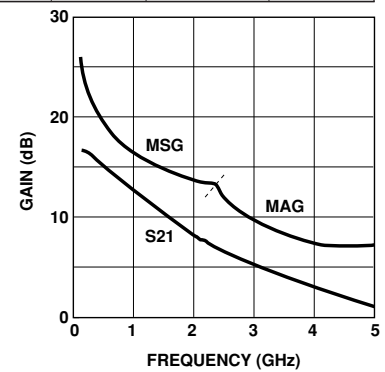
Figure 23. AT-32011 Gains vs. Frequency at $V_{CE} = 5 \text{ V}, I_C = 2 \text{ mA}$.**AT-32033 Typical Scattering Parameters, Common Emitter, $Z_o = 50 \Omega$** $V_{CE} = 5 \text{ V}, I_C = 2 \text{ mA}$

Freq. GHz	S_{11}		S_{21}			S_{12}			S_{22}	
	Mag	Ang	dB	Mag	Ang	dB	Mag	Ang	Mag	Ang
0.1	0.94	-13	16.56	6.73	167	-35.39	0.017	82	0.99	-5
0.5	0.69	-54	14.34	5.21	128	-23.74	0.065	62	0.85	-21
0.9	0.45	-82	11.62	3.81	102	-20.92	0.090	56	0.73	-28
1.0	0.40	-89	11.03	3.56	98	-20.35	0.096	55	0.72	-30
1.5	0.23	-121	8.33	2.61	77	-18.49	0.119	56	0.66	-35
1.8	0.17	-147	7.04	2.25	68	-17.39	0.135	58	0.65	-37
2.0	0.15	-167	6.36	2.08	62	-16.59	0.148	59	0.63	-40
2.4	0.14	151	5.06	1.79	51	-15.14	0.175	60	0.62	-44
3.0	0.20	109	3.52	1.50	37	-12.92	0.226	59	0.61	-53
4.0	0.31	76	1.66	1.21	19	-9.55	0.333	53	0.59	-70
5.0	0.38	55	0.26	1.03	5	-6.80	0.457	42	0.55	-90

AT-32033 Typical Noise Parameters,Common Emitter, $Z_o = 50 \Omega, 5 \text{ V}, I_C = 2 \text{ mA}$

Freq. GHz	F_{min} dB	Γ_{opt}		R_n -
		Mag	Ang	
0.5 ^[1]	0.52	0.79	15	0.42
0.9	0.75	0.65	48	0.30
1.8	1.26	0.33	127	0.11
2.4	1.60	0.39	-166	0.07

Note:

1. 0.5 GHz noise parameter values are extrapolated, not measured.

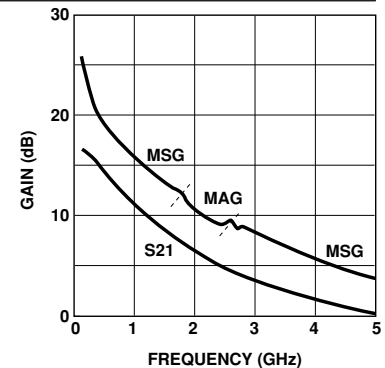
Figure 24. AT-32033 Gains vs. Frequency at $V_{CE} = 5 \text{ V}, I_C = 2 \text{ mA}$.

AT-32011 Typical Scattering Parameters, Common Emitter, $Z_o = 50 \Omega$ $V_{CE} = 5 \text{ V}, I_C = 20 \text{ mA}$

Freq. GHz	S_{11}		S_{21}			S_{12}			S_{22}	
	Mag	Ang	dB	Mag	Ang	dB	Mag	Ang	Mag	Ang
0.1	0.58	-43	31.28	36.64	151	-38.13	0.012	72	0.83	-21
0.5	0.35	-128	23.51	14.99	103	-29.05	0.035	62	0.42	-40
0.9	0.31	-161	18.93	8.84	87	-25.30	0.054	64	0.33	-40
1.0	0.30	-167	18.06	8.00	84	-24.57	0.059	64	0.32	-40
1.5	0.29	170	14.74	5.46	72	-21.50	0.084	63	0.30	-44
1.8	0.30	158	13.22	4.58	65	-20.06	0.099	61	0.29	-47
2.0	0.30	151	12.35	4.15	61	-19.23	0.109	60	0.29	-50
2.4	0.32	138	10.85	3.49	53	-17.77	0.129	57	0.28	-56
3.0	0.35	121	8.99	2.82	42	-16.03	0.158	52	0.27	-64
4.0	0.41	98	6.64	2.15	25	-13.85	0.203	42	0.25	-80
5.0	0.48	83	4.90	1.76	9	-12.12	0.248	33	0.24	-100

AT-32011 Typical Noise Parameters,Common Emitter, $Z_o = 50 \Omega, 5 \text{ V}, I_C = 20 \text{ mA}$

Freq. GHz	F_{min} dB	Γ_{opt}		R_n -
		Mag	Ang	
0.5 ^[1]	1.38	0.18	50	0.20
0.9	1.50	0.15	88	0.16
1.8	1.78	0.23	176	0.13
2.4	1.96	0.34	-156	0.12

Note:

1. 0.5 GHz noise parameter values are extrapolated, not measured.

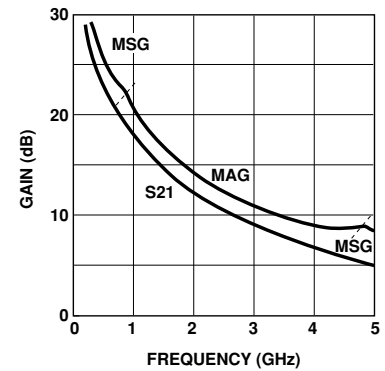
Figure 25. AT-32011 Gains vs. Frequency at $V_{CE} = 5 \text{ V}, I_C = 20 \text{ mA}$.**AT-32033 Typical Scattering Parameters, Common Emitter, $Z_o = 50 \Omega$** $V_{CE} = 5 \text{ V}, I_C = 20 \text{ mA}$

Freq. GHz	S_{11}		S_{21}			S_{12}			S_{22}	
	Mag	Ang	dB	Mag	Ang	dB	Mag	Ang	Mag	Ang
0.1	0.55	-31	30.00	31.61	138	-37.72	0.013	78	0.81	-16
0.5	0.20	-44	19.91	9.90	95	-25.85	0.051	77	0.56	-19
0.9	0.13	-31	15.15	5.72	82	-21.01	0.089	75	0.53	-22
1.0	0.12	-28	14.30	5.19	79	-20.18	0.098	74	0.53	-23
1.5	0.10	-7	11.03	3.56	68	-16.77	0.145	69	0.52	-30
1.8	0.09	5	9.63	3.03	61	-15.19	0.174	66	0.51	-33
2.0	0.10	13	8.82	2.76	57	-14.33	0.192	64	0.50	-36
2.4	0.11	25	7.49	2.37	50	-12.77	0.230	60	0.49	-42
3.0	0.13	36	5.93	1.98	39	-10.90	0.285	54	0.47	-51
4.0	0.18	42	4.19	1.62	23	-8.50	0.376	43	0.42	-67
5.0	0.22	43	2.98	1.41	8	-6.65	0.465	31	0.37	-86

AT-32033 Typical Noise Parameters,Common Emitter, $Z_o = 50 \Omega, 5 \text{ V}, I_C = 20 \text{ mA}$

Freq. GHz	F_{min} dB	Γ_{opt}		R_n -
		Mag	Ang	
0.5 ^[1]	1.38	0.25	35	0.30
0.9	1.50	0.19	85	0.23
1.8	1.78	0.21	-150	0.14
2.4	1.96	0.39	-114	0.19

Note:

1. 0.5 GHz noise parameter values are extrapolated, not measured.

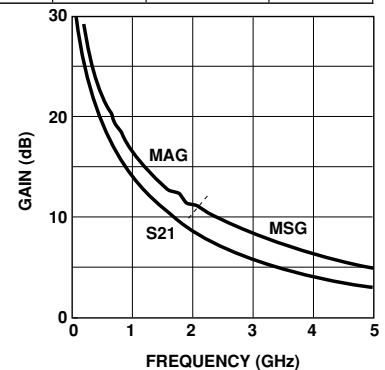
Figure 26. AT-32033 Gains vs. Frequency at $V_{CE} = 5 \text{ V}, I_C = 20 \text{ mA}$.

Ordering Information

Part Numbers		No. of Devices	Comments
AT-32011-BLK	AT-32033-BLK	100	Bulk
AT-32011-BLKG	AT-32033-BLKG	100	Bulk
AT-32011-TR1	AT-32033-TR1	3000	7" Reel
AT-32011-TR1G	AT-32033-TR1G	3000	7" Reel
AT-32011-TR2	AT-32033-TR2	10000	13" Reel
AT-32011-TR2G	AT-32033-TR2G	10000	13" Reel

Note: Order part number with a "G" suffix if lead-free option is desired.

Package Dimensions

SOT-23 Plastic Package

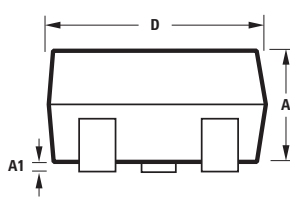
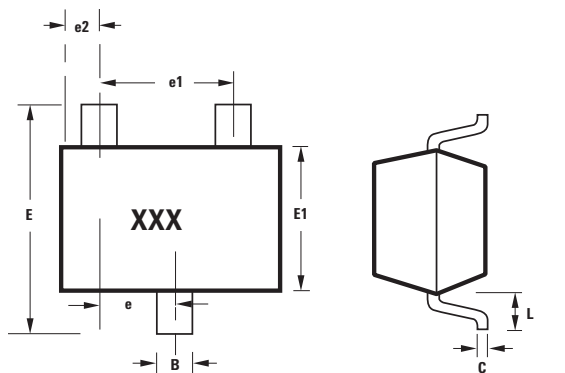

Notes:
XXX-package marking
Drawings are not to scale

SYMBOL	DIMENSIONS (mm)	
	MIN.	MAX.
A	0.79	1.20
A1	0.000	0.100
B	0.37	0.54
C	0.086	0.152
D	2.73	3.13
E1	1.15	1.50
e	0.89	1.02
e1	1.78	2.04
e2	0.45	0.60
E	2.10	2.70
L	0.45	0.69

SOT-143 Plastic Package

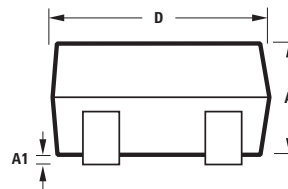
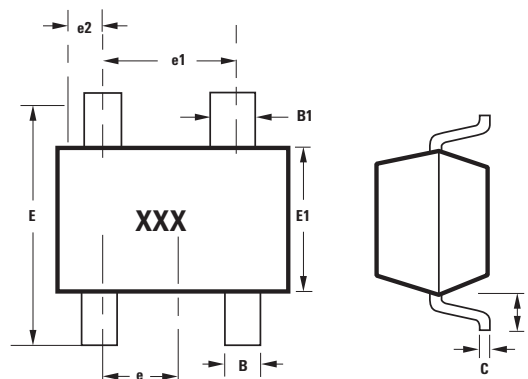

Notes:
XXX-package marking
Drawings are not to scale

SYMBOL	DIMENSIONS (mm)	
	MIN.	MAX.
A	0.79	1.097
A1	0.013	0.10
B	0.36	0.54
B1	0.76	0.92
C	0.086	0.152
D	2.80	3.06
E1	1.20	1.40
e	0.89	1.02
e1	1.78	2.04
e2	0.45	0.60
E	2.10	2.65
L	0.45	0.69

For product information and a complete list of distributors, please go to our web site:

www.avagotech.com

Avago, Avago Technologies, and the A logo are trademarks of Avago Technologies, Limited in the United States and other countries.

Data subject to change. Copyright © 2006 Avago Technologies, Limited. All rights reserved.

Obsoletes 5965-8920E

5989-2643EN August 8, 2006

AVAGO
TECHNOLOGIES