

### FEATURES

- Fast read access time: 90 ns
- Industrial and commercial temperature ranges available
- High-speed programming  
— Typically less than 16 seconds
- Single 2.7V to 3.6V power supply
- JEDEC-approved pinout
- Standard 40-pin PDIP and TSOP, and 44-pin PLCC packages

### DESCRIPTION

The *ISSI* IS27LV2048 is an ultra-high-speed 2 megabit (131K-word by 16-bit) CMOS Programmable Read-Only Memory. This superior random access capability results from a focused high-speed design.

The device is ideal for use with the faster processors. Designers may take full advantage of high-speed digital signal processors and microprocessors by allowing code to be executed at full speed directly out of EPROM. Typical applications include laser printers, switching networks, graphics, workstations, high-speed modems, and digital signal processing.

The IS27LV2048 uses *ISSI*'s write programming algorithm which allows the entire chip to be programmed in typically less than 16 seconds.

This product is available in One-Time Programmable (OTP) PDIP, PLCC, and TSOP packages over commercial and industrial temperature ranges.

### FUNCTIONAL BLOCK DIAGRAM

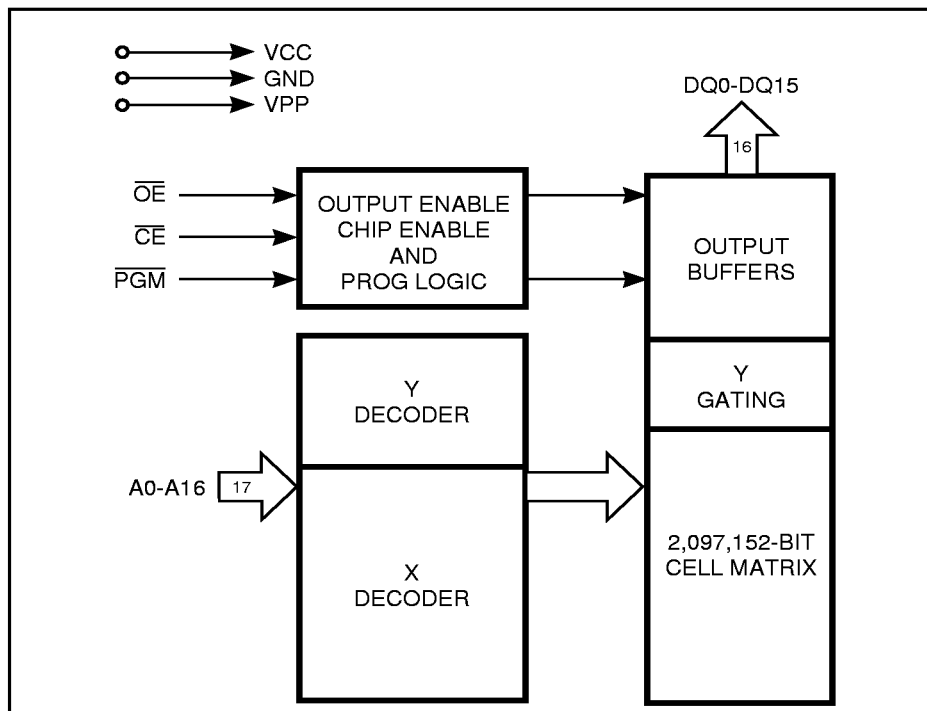

This document contains ADVANCE INFORMATION data. ISSI reserves the right to make changes to its products at any time without notice in order to improve design and supply the best possible product. We assume no responsibility for any errors which may appear in this publication. © Copyright 1996, Integrated Silicon Solution, Inc.

**PIN CONFIGURATIONS**

**40-Pin DIP**

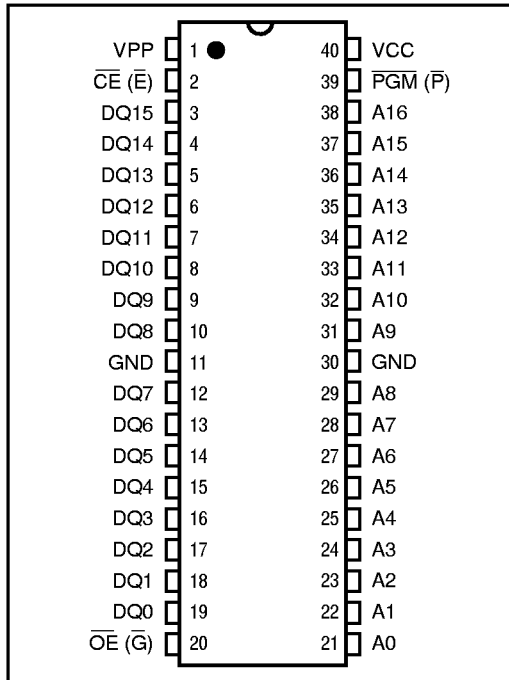

**PIN DESCRIPTIONS**

A0-A16	Address Inputs
$\overline{CE} (\overline{E})$	Chip Enable Input
DQ0-DQ15	Data Inputs/Outputs
$\overline{OE} (\overline{G})$	Output Enable Input
PGM ( $\overline{P}$ )	Program Enable Input
Vcc	Power Supply Voltage
VPP	Program Supply Voltage
GND	Ground

**44-Pin PLCC**

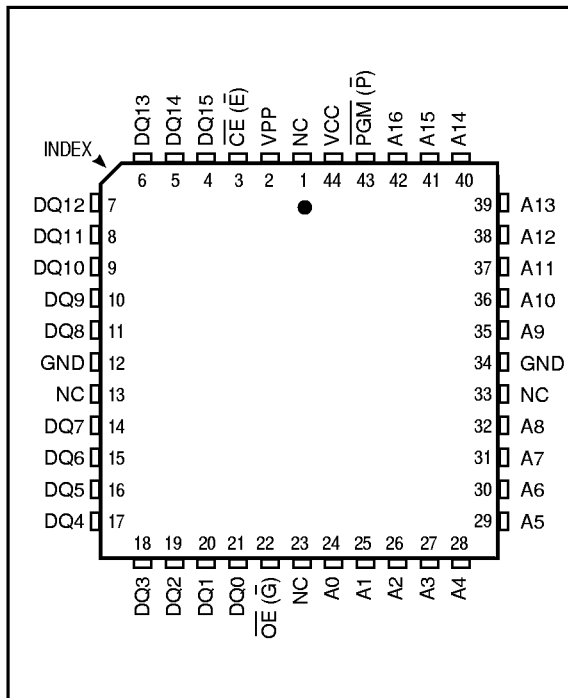

**40-Pin TSOP**

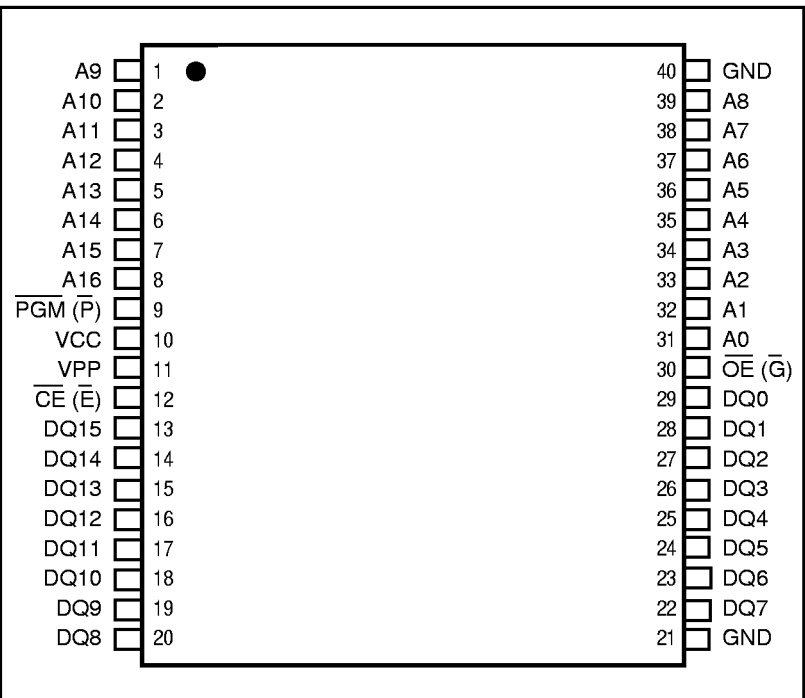

## FUNCTIONAL DESCRIPTION

### Programming the IS27LV2048

Upon delivery, the IS27LV2048 has 2,097,152 bits in the "ONE", or HIGH state. "ZEROs" are loaded into the IS27LV2048 through the procedure of programming.

The programming mode is entered when  $12.5 \pm 0.25V$  is applied to the  $V_{PP}$  pin,  $V_{CC} = 6V$ ,  $\overline{CE}$  and  $\overline{PGM}$  is at  $V_{IL}$ , and  $\overline{OE}$  is at  $V_{IH}$ . For programming, the data to be programmed is applied eight bits in parallel to the data output pins.

The write programming algorithm reduces programming time by using 100  $\mu s$  programming pulses followed by a byte verification to determine whether the byte has been successfully programmed. If the data does not verify, an additional pulse is applied for a maximum of 25 pulses. This process is repeated while sequencing through each address of the EPROM.

The write programming algorithm programs and verifies at  $V_{CC} = 6V$  and  $V_{PP} = 12.5V$ . After the final address is completed, all byte are compared to the original data with  $V_{CC} = 5.25V$ .

### Program Inhibit

Programming of multiple IS27LV2048s in parallel with different data is also easily accomplished. Except for  $\overline{CE}$ , all like inputs of the parallel IS27LV2048 may be common. A TTL low-level program pulse applied to an IS27LV2048  $\overline{CE}$  input with  $V_{PP} = 12.5 \pm 0.25V$ ,  $\overline{PGM}$  LOW and  $\overline{OE}$  HIGH will program that IS27LV2048. A high-level  $\overline{CE}$  input inhibits the other IS27LV2048 from being programmed.

### Program Verify

A verify should be performed on the programmed bits to determine that they were correctly programmed. The verify should be performed with  $\overline{OE}$  and  $\overline{CE}$  at  $V_{IL}$ ,  $\overline{PGM}$  at  $V_{IH}$ , and  $V_{PP}$  between 12.25V and 12.75V.

### Auto Select Mode

The auto select mode allows the reading out of a binary code from an EPROM that will identify its manufacturer and type. This mode is intended for use by programming equipment for the purpose of automatically matching the device to be programmed with its corresponding programming algorithm. This mode is functional in the  $25^{\circ}C \pm 5^{\circ}C$  ambient temperature range that is required when programming the IS27LV2048.

To activate this mode, the programming equipment must force  $12.0 \pm 0.5V$  on address line A9 of the IS27LV2048. Two identifier bytes may then be sequenced from the device outputs by toggling address line A0 from  $V_{IL}$  to  $V_{IH}$ . All other address lines must be held at  $V_{IL}$  during auto select mode.

Byte 0 ( $A0 = V_{IL}$ ) represents the manufacturer code, and byte 1 ( $A0 = V_{IH}$ ), the device identifier code. For the IS27LV2048, these two identifier bytes are given in the Mode Select table. All identifiers manufacturer and device codes will possess odd parity, with the MSB (DQ7) defined as the parity bit.

### Read Mode

The IS27LV2048 has two control functions, both of which must be logically satisfied in order to obtain data at the outputs. Chip Enable ( $\overline{CE}$ ) is the power control and should be used for device selection. Assuming that addresses are stable, address access time ( $t_{ACC}$ ) is equal to the delay from  $\overline{CE}$  to output ( $t_{CE}$ ). Output Enable ( $\overline{OE}$ ) is the output control and should be used to get data to the output pins, independent of device selection. Data is available at the outputs  $t_{OE}$  after the falling edge of  $\overline{OE}$  assuming that  $\overline{CE}$  has been LOW and addresses have been stable for at least  $t_{ACC} - t_{OE}$ .

### Standby Mode

The IS27LV2048 has a standby mode which reduces the maximum  $V_{CC}$  active current. It is placed in standby mode when  $\overline{CE}$  is at  $V_{IH}$ . The amount of current drawn in standby mode depends on the frequency and the number of address pins switching. The IS27LV2048 is specified with 50% of the address lines toggling at 10 MHz. A reduction of the frequency or quantity of address lines toggling will significantly reduce the actual standby current.

### Output OR-Tieing

To accommodate multiple memory connections, a two-line control function is provided to allow for:

1. Low memory power dissipation, and
2. Assurance that output bus contention will not occur.

It is recommended that  $\overline{CE}$  be decoded and used as the primary device-selecting function, while  $\overline{OE}$  be made a common connection to all devices in the array and connected to the READ line from the system control bus. This assures that all deselected memory devices are in their low-power standby mode and that the output pins are only active when data is desired from a particular memory device.

### System Applications

During the switch between active and standby conditions, transient current peaks are produced on the rising and falling edges of Chip Enable. The magnitude of these transient current peaks is dependent on the output capacitance loading of the device at a minimum, a 0.1  $\mu\text{F}$  ceramic capacitor (high-frequency, low inherent inductance) should be used on each device between  $V_{CC}$  and GND to minimize transient effects. In addition, to overcome the voltage drop caused by the inductive effects of the printed circuit board traces on EPROM arrays, a 4.7  $\mu\text{F}$  bulk electrolytic capacitor should be used between  $V_{CC}$  and GND for each eight devices. The location of the capacitor should be close to where the power supply is connected to the array.

### TRUTH TABLE<sup>(1,2)</sup>

Mode	$\overline{CE}$	$\overline{OE}$	$\overline{PGM}$	A0	A9	$V_{PP}$	Outputs
Read	$V_{IL}$	$V_{IL}$	X	X	X	$V_{CC}$	DOUT
Output Disable	$V_{IL}$	$V_{IH}$	X	X	X	$V_{CC}$	Hi-Z
Standby	$V_{IH}$	X	X	X	X	$V_{CC}$	Hi-Z
Program	$V_{IL}$	$V_{IH}$	$V_{IL}$	X	X	$V_{PP}$	DIN
Program Verify	$V_{IL}$	$V_{IL}$	$V_{IH}$	X	X	$V_{PP}$	DOUT
Program Inhibit	$V_{IH}$	X	X	X	X	$V_{PP}$	Hi-Z
Auto Select <sup>(3)</sup>	Manufacturer Code	$V_{IL}$	X	$V_{IL}$	$V_{H}$	$V_{CC}$	D5H
	Device Code	$V_{IL}$	X	$V_{IH}$	$V_{H}$	$V_{CC}$	98H

#### Notes:

1.  $V_{H} = 12.0V \pm 0.5V$ .
2. X = Either  $V_{IH}$  or  $V_{IL}$ .
3. A1-A8 = A10-A17 =  $V_{IL}$ .
4. See DC Programming Characteristics for  $V_{PP}$  voltage during programming.

### LOGIC SYMBOL

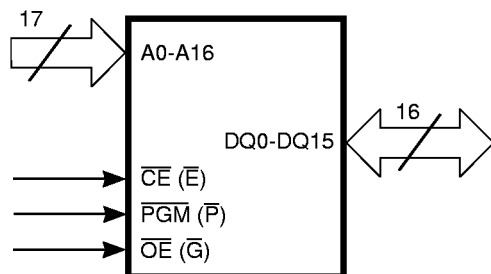

**ABSOLUTE MAXIMUM RATINGS<sup>(1)</sup>**

Symbol	Parameter	Value	Unit
V <sub>TERM</sub>	Terminal Voltage with Respect to GND		
	All pins except A9 and V <sub>PP</sub>	-0.6 to V <sub>CC</sub> + 0.5 <sup>(2)</sup>	V
	V <sub>PP</sub>	V <sub>CC</sub> - 0.3 to 13.5 <sup>(2,3)</sup>	V
	A9	-0.6 to 13.5 <sup>(2,3)</sup>	V
	V <sub>CC</sub>	-0.6 to 7.0 <sup>(2)</sup>	V
T <sub>A</sub>	Ambient Temperature with Power Applied	-65 to +125	°C
T <sub>STG</sub>	Storage Temperature (OTP)	-65 to +125	°C
T <sub>STG</sub>	Storage Temperature (All others)	-65 to +150	°C

**Notes:**

1. Stress greater than those listed under ABSOLUTE MAXIMUM RATINGS may cause permanent damage to the device. This is a stress rating only and functional operation of the device at these or any other conditions above those indicated in the operational sections of this specification is not implied. Exposure to absolute maximum rating conditions for extended periods may affect reliability.
2. Minimum DC input voltage is -0.5V. During transitions, inputs may undershoot to -2.0V for periods less than 10 ns. Maximum DC voltage on output pins is V<sub>CC</sub> + 0.5V which may overshoot to V<sub>CC</sub> + 2.0V for periods less than 10 ns.
3. Maximum DC voltage on A9 or V<sub>PP</sub> may overshoot to +13.5V for periods less than 10 ns.

**OPERATING RANGE**

Range	Ambient Temperature	V <sub>CC</sub>
Commercial	0°C to +70°C	2.7V to 3.6V
Industrial <sup>(1)</sup>	-40°C to +85°C	2.7V to 3.6V

**Note:**

1. Operating ranges define those limits between which the functionality of the device is guaranteed.

**DC ELECTRICAL CHARACTERISTICS<sup>(1,2,3)</sup> (Over Operating Range)**

Symbol	Parameter	Test Conditions	Min.	Max.	Unit
V <sub>OH</sub>	Output HIGH Voltage	V <sub>CC</sub> = Min., I <sub>OH</sub> = -400 μA	2.4	—	V
V <sub>OL</sub>	Output LOW Voltage	V <sub>CC</sub> = Min., I <sub>OL</sub> = 2.1 mA	—	0.4	V
V <sub>IH</sub>	Input HIGH Voltage <sup>(4)</sup>		2.0	V <sub>CC</sub> + 0.5	V
V <sub>IL</sub>	Input LOW Voltage <sup>(4)</sup>		-0.3	0.8	V
I <sub>LI</sub>	Input Load Current	V <sub>IN</sub> = 0V to +V <sub>CC</sub>	—	5	μA
I <sub>LO</sub>	Output Leakage Current	V <sub>OUT</sub> = 0V to +V <sub>CC</sub>	—	5	μA

**Notes:**

1. V<sub>CC</sub> must be applied simultaneously or before V<sub>PP</sub> and removed simultaneously or after V<sub>PP</sub>. Never try to force V<sub>PP</sub> LOW to 1V below V<sub>CC</sub>. Manufacturer suggests to tie V<sub>PP</sub> and V<sub>CC</sub> together during the READ operation.
2. **Caution:** the IS27LV2048 must not be removed from (or inserted into) a socket when V<sub>CC</sub> or V<sub>PP</sub> is applied.
3. Minimum DC input voltage is -0.5V. During transitions, the inputs may undershoot to -2.0V for periods less than 10 ns. Maximum DC voltage on output pins is V<sub>CC</sub> + 0.5V which may overshoot to V<sub>CC</sub> + 2.0V for periods less than 10 ns.
4. Tested under static DC conditions.

**POWER SUPPLY CHARACTERISTICS<sup>(1,2,5)</sup>** (Over Operating Range)

Symbol	Parameter	Test Conditions	Min.	Max.	Unit
I <sub>CC1</sub>	V <sub>CC</sub> Operating Supply Current <sup>(3)</sup>	V <sub>CC</sub> = Max., $\overline{CE} = V_{IL}$ I <sub>OUT</sub> = 0 mA, f = 10 MHz (Open outputs)	—	10	mA
I <sub>PP1</sub>	V <sub>PP</sub> Current During Read <sup>(4)</sup>	V <sub>CC</sub> = Max., $\overline{CE} = \overline{OE} = V_{IL}$ V <sub>PP</sub> = V <sub>CC</sub>	—	10	μA
I <sub>CCSB0</sub>	V <sub>CC</sub> CMOS Standby Current	$\overline{CE} = V_{CC} - 0.3V$ (No toggling)	—	20	μA
I <sub>CCSB1</sub>	V <sub>CC</sub> TTL Standby Current	$\overline{CE} = V_{IH}$ (No toggling)	—	200	μA

**Notes:**

- V<sub>CC</sub> must be applied simultaneously or before V<sub>PP</sub> and removed simultaneously or after V<sub>PP</sub>. Never try to force V<sub>PP</sub> LOW to 1V below V<sub>CC</sub>. Manufacturer suggests to tie V<sub>PP</sub> and V<sub>CC</sub> together during the READ operation.
- Caution:** the IS27LV2048 must not be removed from (or inserted into) a socket when V<sub>CC</sub> or V<sub>PP</sub> is applied.
- I<sub>CC1</sub> is tested with  $\overline{OE} = V_{IH}$  to simulate open outputs.
- Maximum active power usage is the sum of I<sub>CC</sub> and I<sub>PP</sub>.
- Minimum DC input voltage is -0.5V. During transitions, the inputs may undershoot to -2.0V for periods less than 10 ns. Maximum DC voltage on output pins is V<sub>CC</sub> + 0.5V which may overshoot to V<sub>CC</sub> + 2.0V for periods less than 10 ns.

**CAPACITANCE<sup>(1,2,3)</sup>**

Symbol	Parameter	Conditions	DIP		PLCC		TSOP		Unit
			Typ.	Max.	Typ.	Max.	Typ.	Max.	
C <sub>IN</sub>	Address Input Capacitance	V <sub>IN</sub> = 0V	10	12	7	10	10	12	pF
C <sub>OUT</sub>	Output Capacitance	V <sub>OUT</sub> = 0V	12	15	12	14	12	14	pF

**Notes:**

- Typical values are for nominal supply voltage.
- This parameter is only sampled, but not 100% tested.
- Test conditions: T<sub>A</sub> = 25°C, f = 1 MHz.

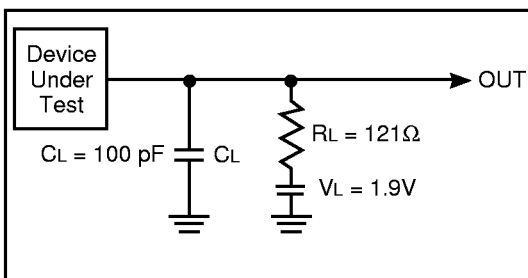
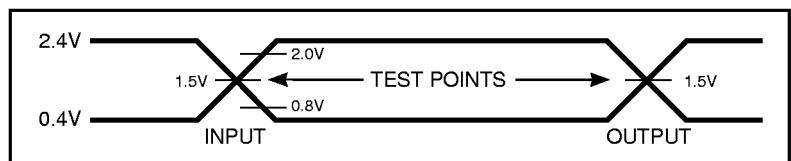
**SWITCHING TEST CIRCUIT****SWITCHING TEST WAVEFORM****Notes:****AC Testing:**

- Inputs are driven at 2.4V for a logic "1" and 0.4V for a logic "0".
- Input pulse rise and fall skew rate  $\geq 1.5V/ns$ .
- C<sub>L</sub> = 30 pF for 45 ns speed grades.

**SWITCHING CHARACTERISTICS**<sup>(1,3,4)</sup> (Over Operating Range)

JEDEC Symbol	Std. Symbol	Parameter	Test Conditions	-90		-12		Unit
				Min.	Max.	Min.	Max.	
t <sub>AVQA</sub>	t <sub>ACC</sub>	Address to Output Delay	$\overline{CE} = \overline{OE} = V_{IL}$	—	90	—	120	ns
t <sub>ELQV</sub>	t <sub>CE</sub>	Chip Enable to Output Delay	$\overline{OE} = V_{IL}$	—	90	—	120	ns
t <sub>GLQV</sub>	t <sub>OE</sub>	Output Enable to Output Delay	$\overline{CE} = V_{IL}$	—	45	—	50	ns
t <sub>EHOZ</sub> , t <sub>GHQZ</sub>	t <sub>DF</sub> <sup>(2)</sup>	Chip Enable HIGH or Output Enable HIGH, whichever comes first, to Output Float		0	30	0	35	ns
t <sub>AVOX</sub>	t <sub>OH</sub>	Output Hold from Address, $\overline{CE}$ or $\overline{OE}$ whichever occurred first		0	—	0	—	ns

**Notes:**

- V<sub>CC</sub> must be applied simultaneously or before V<sub>PP</sub> and removed simultaneously or after V<sub>PP</sub>.
- This parameter is only sampled, not 100% tested.
- Caution:** The IS27LV2048 must not be removed from (or inserted into) a socket or board when V<sub>PP</sub> or V<sub>CC</sub> applied.
- Output Load: 1 TTL gate and C = CL.  
Input Rise and Fall times: 20 ns.  
Input Pulse Levels: 0.4V to 2.4V.  
Timing Measurement Reference Level: 0.8V and 2.0V inputs and outputs.

**SWITCHING WAVEFORMS**

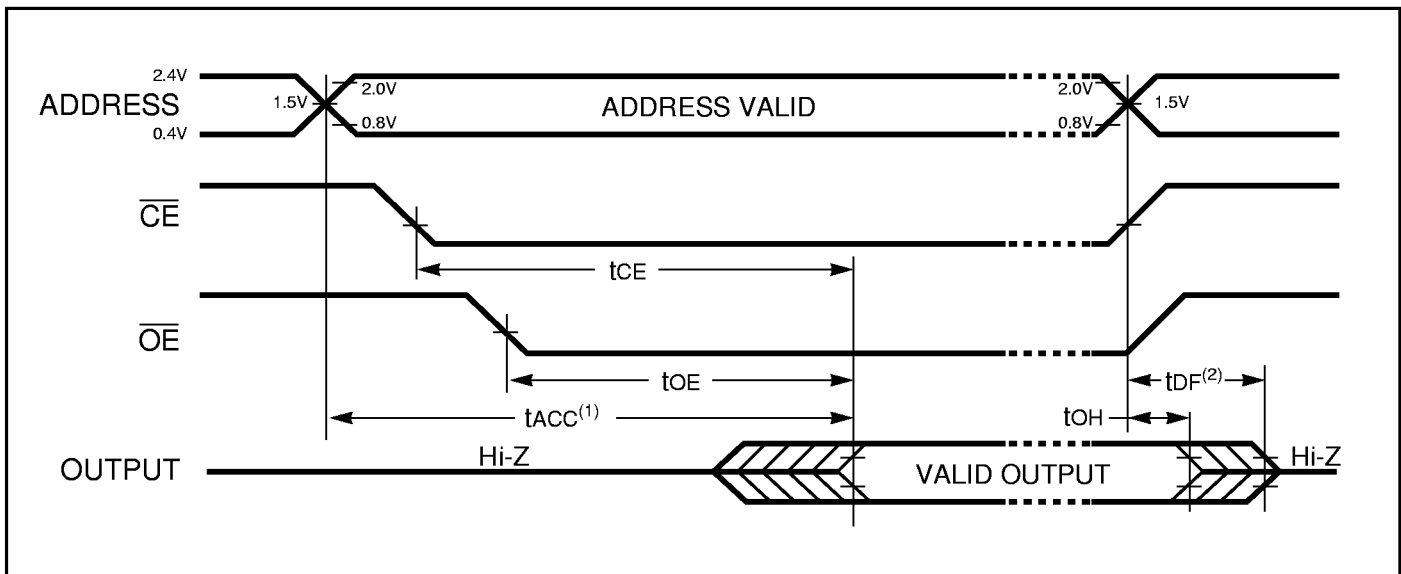

**Notes:**

- $\overline{OE}$  may be delayed up to t<sub>ACC</sub> – t<sub>OE</sub> after the falling edge of  $\overline{CE}$  without impact on t<sub>acc</sub>.
- t<sub>DF</sub> is specified from  $\overline{OE}$  or  $\overline{CE}$ , whichever occurs first.

**DC PROGRAMMING CHARACTERISTICS**<sup>(1,2,3,4)</sup> ( $T_A = +25^\circ\text{C} \pm 5^\circ\text{C}$ )

Symbol	Parameter	Test Conditions	Min.	Max.	Unit
V <sub>OH</sub>	Output HIGH Voltage During Verify	I <sub>OH</sub> = -400 $\mu$ A	2.4	—	V
V <sub>OL</sub>	Output LOW Voltage During Verify	I <sub>OL</sub> = 2.1 mA	—	0.45	V
V <sub>IH</sub>	Input HIGH Voltage		2.0	V <sub>CC</sub> + 0.5	V
V <sub>IL</sub>	Input LOW Voltage (All Inputs)		-0.3	0.8	V
V <sub>H</sub>	A9 Auto Select Voltage		11.5	12.5	V
I <sub>LI</sub>	Input Current (All Inputs)	V <sub>IN</sub> = V <sub>IL</sub> or V <sub>IH</sub>	—	5.0	$\mu$ A
I <sub>CC</sub>	V <sub>CC</sub> Supply Current		—	50	mA
I <sub>PP</sub>	V <sub>PP</sub> Supply Current	$\overline{\text{CE}} = \text{V}_{\text{IL}}, \overline{\text{OE}} = \text{V}_{\text{IH}}$	—	30	mA
V <sub>CC</sub>	Supply Voltage		5.75	6.25	V
V <sub>PP</sub>	Programming Voltage		12.25	12.75	V

**SWITCH PROGRAMMING CHARACTERISTICS**<sup>(1,2,3,4)</sup> ( $T_A = +25^\circ\text{C} \pm 5^\circ\text{C}$ )

JEDEC Symbol	Std. Symbol	Parameter	Min.	Max.	Unit
t <sub>AVEL</sub>	t <sub>AS</sub>	Address Setup Time	2	—	$\mu$ s
t <sub>DZGL</sub>	t <sub>OES</sub>	$\overline{\text{OE}}$ Setup Time	2	—	$\mu$ s
t <sub>DVEL</sub>	t <sub>DS</sub>	Data Setup Time	2	—	$\mu$ s
t <sub>GHAX</sub>	t <sub>AH</sub>	Address Hold Time	0	—	$\mu$ s
t <sub>EHDX</sub>	t <sub>DH</sub>	Data Hold Time	2	—	$\mu$ s
t <sub>GHQZ</sub>	t <sub>DFP</sub>	$\overline{\text{OE}}$ HIGH to Output Float Delay	0	130	ns
t <sub>VPS</sub>	t <sub>VPS</sub>	V <sub>PP</sub> Setup Time	2	—	$\mu$ s
t <sub>LEH1</sub>	t <sub>PW</sub>	$\overline{\text{PGM}}$ Program Pulse Width	95	105	$\mu$ s
t <sub>VCS</sub>	t <sub>VCS</sub>	V <sub>CC</sub> Setup Time	2	—	$\mu$ s
t <sub>ELPL</sub>	t <sub>GES</sub>	$\overline{\text{CE}}$ Setup Time	2	—	$\mu$ s
t <sub>GLQV</sub>	t <sub>OE</sub>	Data Valid from $\overline{\text{OE}}$	—	150	ns

**Notes:**

- V<sub>CC</sub> must be applied simultaneously or before V<sub>PP</sub> and removed simultaneously or after V<sub>PP</sub>.
- V<sub>PP</sub> must be  $\geq$  V<sub>CC</sub> during the entire programming and verifying procedure.
- When programming IS27LV2048, a 0.1  $\mu$ F capacitor is required across V<sub>PP</sub> and ground to suppress spurious voltage transients which may damage the device.
- Programming characteristics are sampled but not 100% tested at worst-case conditions.



PROGRAMMING ALGORITHM WAVEFORM<sup>(1,2)</sup>

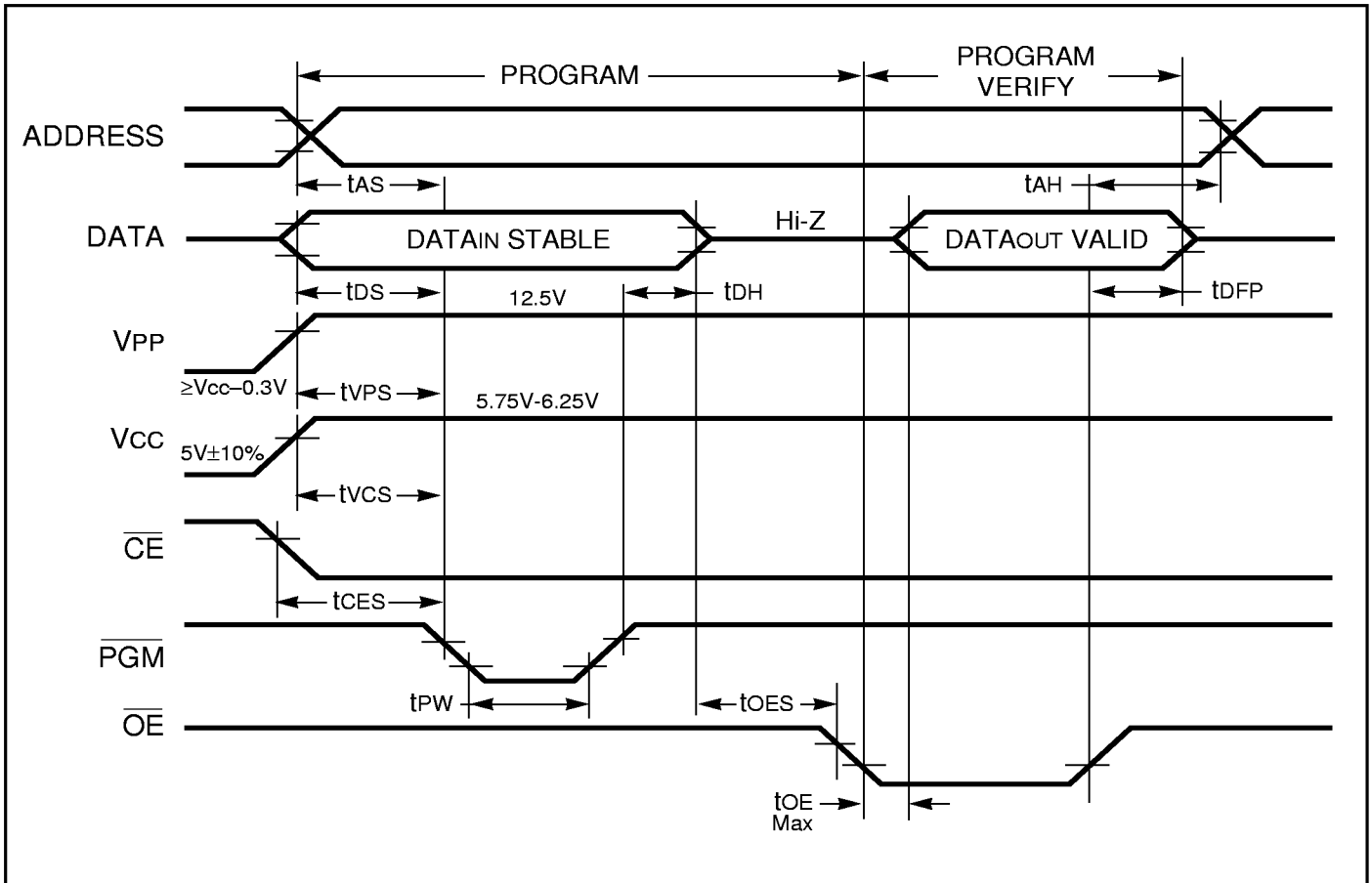

Notes:

1. The timing reference level is 0.8V for  $V_{IL}$  and 2.0V for  $V_{IH}$ .
2.  $t_{OE}$  and  $t_{DFP}$  are characteristics of the device but must be accommodated by the programmer.

**PROGRAMMING FLOW CHART**

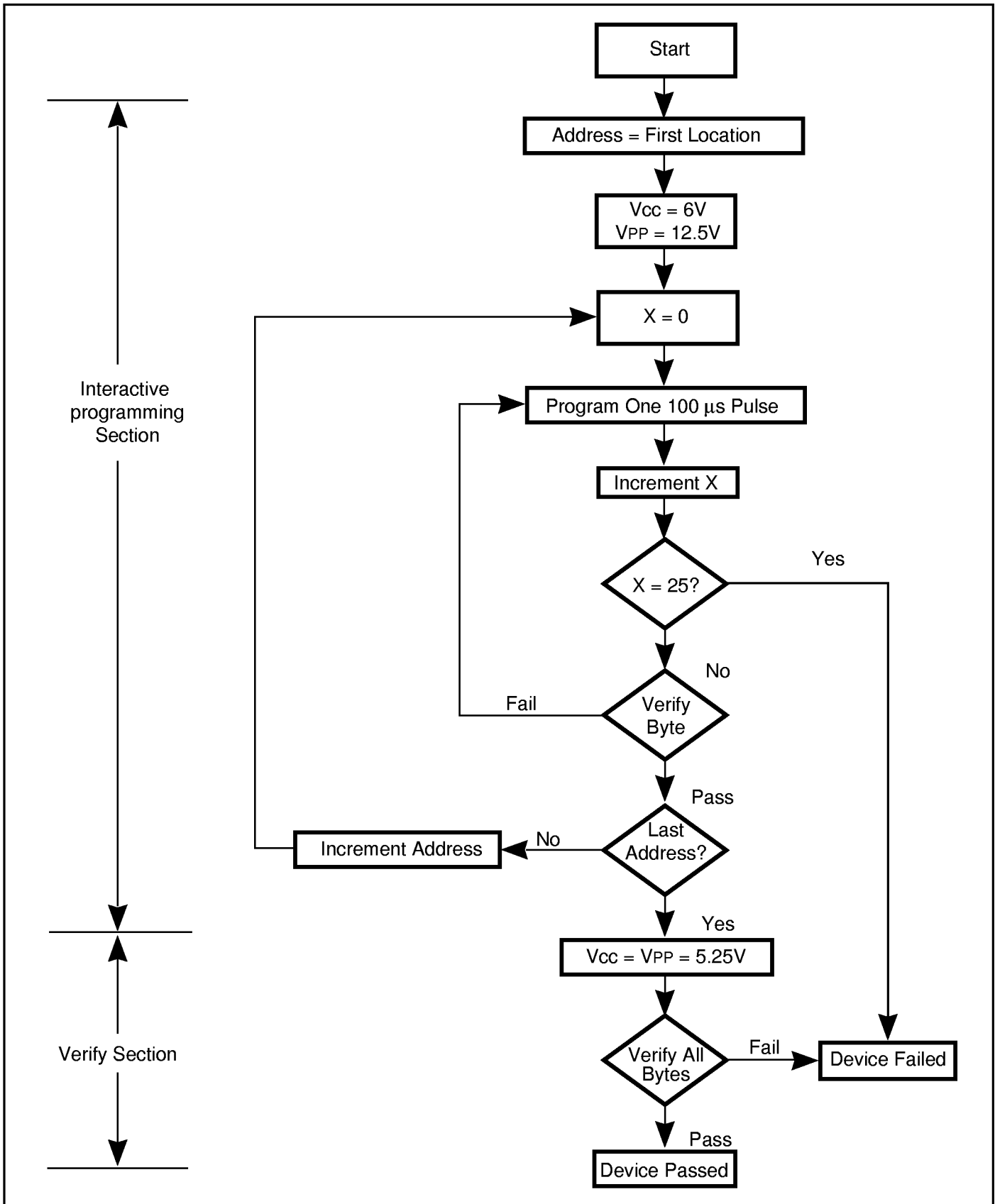

**ORDERING INFORMATION****Commercial Range: 0°C to +70°C**

Speed (ns)	Order Part Number	Package
90	IS27LV2048-90W	600-mil Plastic DIP
	IS27LV2048-90PL	PLCC – Plastic Leaded Chip Carrier
	IS27LV2048-90T	TSOP
120	IS27LV2048-12W	600-mil Plastic DIP
	IS27LV2048-12PL	PLCC – Plastic Leaded Chip Carrier
	IS27LV2048-12T	TSOP

**ORDERING INFORMATION****Industrial Range: –40°C to +85°C**

Speed (ns)	Order Part Number	Package
90	IS27LV2048-90PLI	PLCC – Plastic Leaded Chip Carrier
	IS27LV2048-90TI	TSOP
120	IS27LV2048-12PLI	PLCC – Plastic Leaded Chip Carrier
	IS27LV2048-12TI	TSOP

***Integrated Silicon Solution, Inc.***

2231 Lawson Lane  
 Santa Clara, CA 95054  
 Fax: (408) 588-0806  
 Toll Free: 1-800-379-4774  
<http://www.issiusa.com>

**PLCC (Plastic Leaded Chip Carrier)**

Package Code: PL

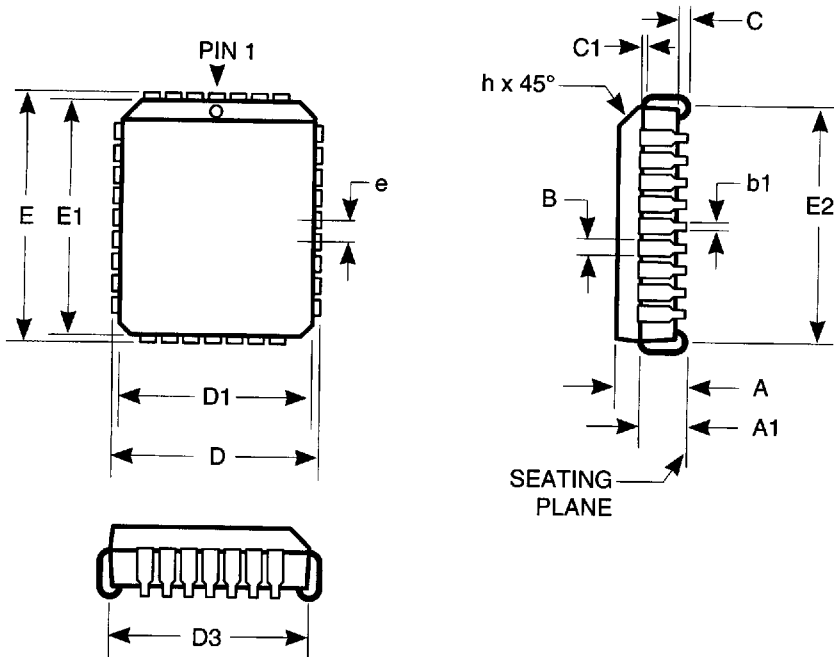

**Plastic Leaded Chip Carrier (PL)**

Inches

Symbol	Min	Max	Min	Max
Ref. Std.				
No. Leads	32		44	
A	0.131	0.140	0.165	0.180
A1	0.075	0.095	0.090	0.120
B	0.026	0.032	0.026	0.032
b1	0.013	0.021	0.013	0.021
C	0.020	0.040	0.020	0.040
C1	0.008	0.014	0.008	0.014
D	0.485	0.495	0.685	0.695
D1	0.447	0.453	0.650	0.656
D2	0.390	0.430	—	—
E	0.585	0.595	0.685	0.695
E1	0.547	0.553	0.650	0.656
E2	0.490	0.530	0.659	0.680
e	0.050 BSC		0.050 BSC	
ND/NE	7/9		11/11	

**Notes:**

1. Controlling dimension: inches, unless otherwise specified.
2. BSC = Basic lead spacing between centers.
3. Dimensions D and E do not include mold flash protrusions.
4. Formed leads shall be planar with respect to one another within 0.004 inches at the seating plane.
5. ND and NE represent the number of leads in D and E directions, respectively.
6. D1 and E1 should be measured from the bottom of the package.

600-mil Plastic DIP

Package Code: W

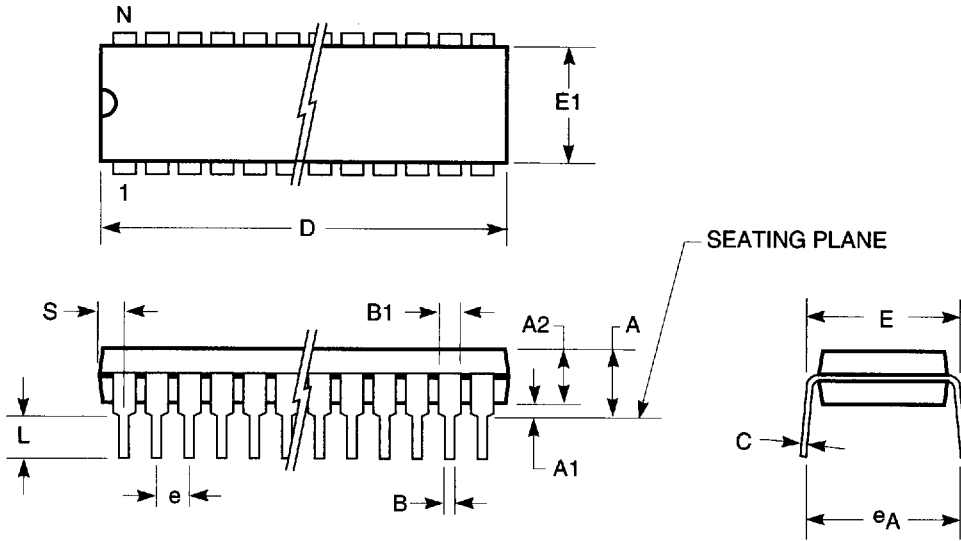

600-mil Plastic DIP (W)

Inches

Symbol	Min	Max	Min	Max	Min	Max
Ref. Std.						
N	28		32		40	
A	0.160	0.185	0.165	0.180	0.165	0.200
A1	0.015	0.035	0.010	—	0.020	0.045
B	0.015	0.020	0.018		0.015	0.022
B1	0.050	0.065	0.050		0.045	0.067
C	0.008	0.012	0.010		0.008	0.015
D	1.420	1.460	1.645	1.655	1.415	1.460
E	0.600	0.620	0.590	0.610	0.600	0.620
E1	0.530	0.550	0.540	0.555	0.530	0.560
eA	0.610	0.670	0.620	0.680	0.600	0.680
e	0.100	BSC	0.100	BSC	0.100	BSC
L	0.120	0.150	0.120	0.140	0.120	0.138
S	0.055	0.080	0.065	0.085	0.055	0.085
$\alpha$	0°	15°	2°	8°	—	—

Notes:

1. Controlling dimension: inches, unless otherwise specified.
2. BSC = Basic lead spacing between centers.
3. Dimensions D and E1 do not include mold flash protrusions and should be measured from the bottom of the package.
4. Formed leads shall be planar with respect to one another within 0.004 inches at the seating plane.

# PACKAGING INFORMATION

ISSI

Plastic TSOP

Package Code: T (Type II)

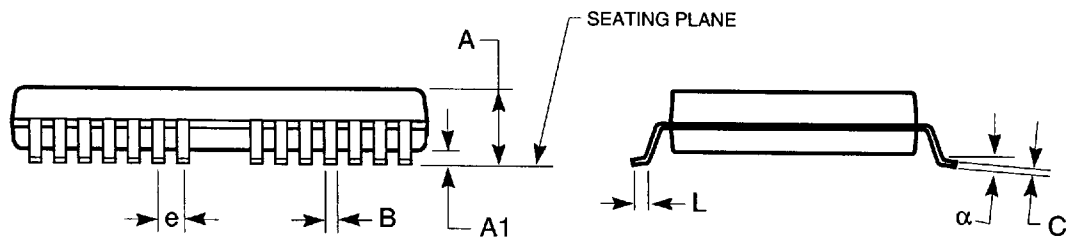
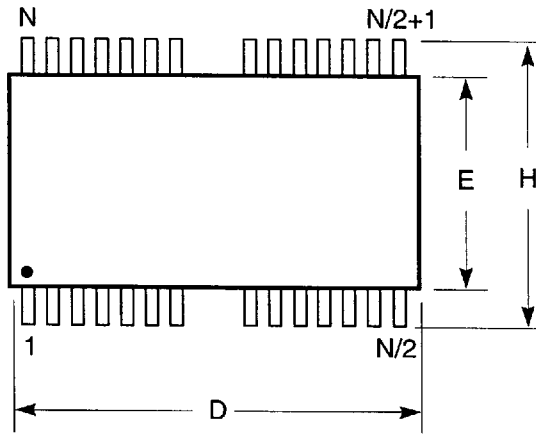

Plastic TSOP (T - Type II)				
Symbol	Millimeters		Inches	
	Min	Max	Min	Max
Ref. Std.				
N	40/44			
A	1.00	1.20	0.039	0.047
A1	0.05	0.20	0.002	0.008
B	0.30	0.40	0.012	0.016
C	0.12	0.21	0.0047	0.0083
D	18.313	18.517	0.721	0.729
E	10.058	10.262	0.396	0.404
e	0.800 BSC		0.0315 BSC	
H	11.735	11.938	0.462	0.470
L	0.432	0.584	0.017	0.023
α	0°	5°	0°	5°

**Notes:**

1. Controlling dimension: millimeters, unless otherwise specified.
2. BSC = Basic lead spacing between centers.
3. Dimensions D and E do not include mold flash protrusions and should be measured from the bottom of the package.
4. Formed leads shall be planar with respect to one another within 0.004 inches at the seating plane.