

8286/8287

Octal Bus Transceivers

DISTINCTIVE CHARACTERISTICS

- Data bus buffer/driver for 8086, 8088, 8080A, 8085A, and 8048 processors
- Fully parallel 8-bit transceivers: 8286 is noninverting, 8287 is inverting
- 3-state inputs/outputs for interfacing with bus-oriented systems
- Available in 20-pin, 0.3" center molded DIP or ceramic package
- Advanced bipolar Schottky processing
- Bus port stays in hi-impedance state during power up/down transition

GENERAL DESCRIPTION

The 8286 and 8287 are 8-bit 3-state bipolar Schottky transceivers. They provide bidirectional drive for bus-oriented microprocessor and digital communications systems. Straight through bidirectional transceivers are featured, with 16mA drive capability on the A ports and 32mA bus drive capability on the B ports. PNP inputs are incorporated to reduce input loading.

One input, Transmit/Receive determines the direction of logic signals through the bidirectional transceiver. The Chip Disable input disables both A and B ports by placing them in a 3-state condition. Chip Disable is functionally the same as an active LOW chip select.

BLOCK DIAGRAM

8286*

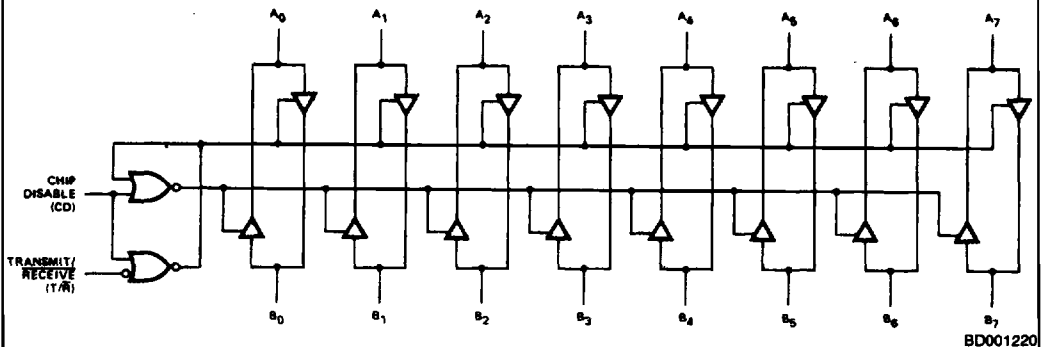

*8287 has inverting transceivers

RELATED PRODUCTS

PART NO	DESCRIPTION
2946/47	Octal Bus Transceivers
2948/49	Octal Bus Transceivers
8086	16-Bit Microprocessor

CONNECTION DIAGRAM
Top View

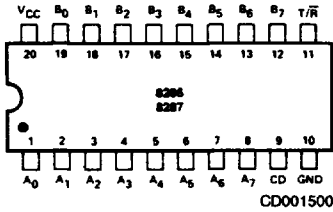

LOGIC SYMBOL

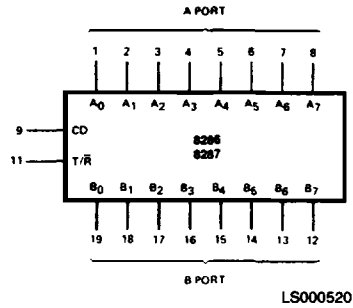

Note: Pin 1 is marked for orientation

METALLIZATION AND PAD LAYOUT

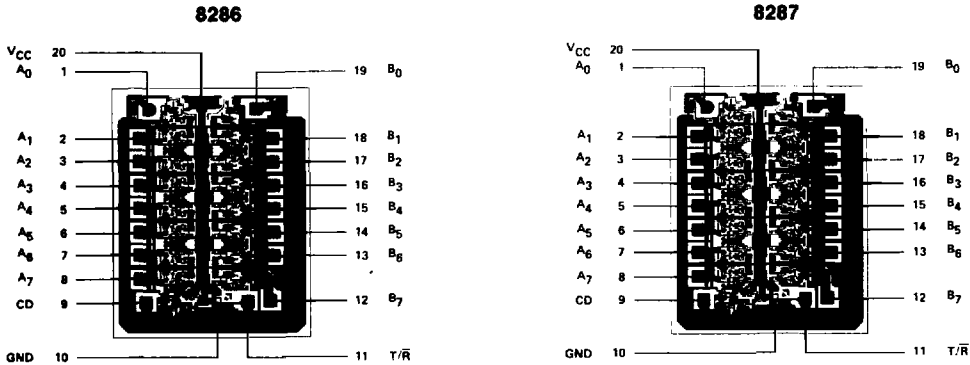

DIE SIZE .069" x .069"

ORDERING INFORMATION

AMD products are available in several packages and operating ranges. The order number is formed by a combination of the following: Device number, speed option (if applicable), package type, operating range and screening option (if desired).

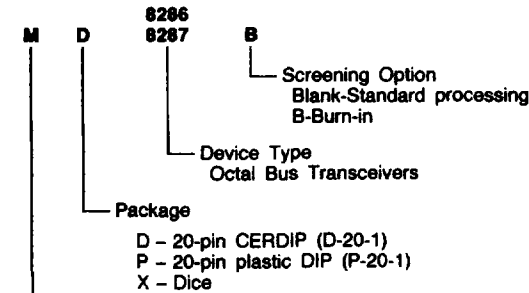

Temperature Range

- C - Commercial (0°C to +70°C)
- M - Military (-55°C to +125°C)

Valid Combinations

MD	8286
D	
P	
XM, XC	
MD	8286B
D	
P	
P	8287
XC	
P	8287B

Valid Combinations

Consult the AMD sales office in your area to determine if a device is currently available in the combination you wish.

PIN DESCRIPTION

Pin No.	Name	I/O	Description
	A ₀ - A ₇	I/O	A port inputs/outputs are receiver output drivers when T/ \bar{R} is Low and are transmit inputs when T/ \bar{R} is HIGH.
	B ₀ - B ₇	I/O	B port inputs/outputs are transmit output drivers when T/ \bar{R} is HIGH and receiver inputs when T/ \bar{R} is LOW.
9	CD	I	Chip Disable forces all output drivers into 3-state when HIGH (same function as active LOW chip select, \bar{CS}).
11	T/ \bar{R}	I	Transmit/Receiver direction control determines whether A port or B port drivers are in 3-state. With T/ \bar{R} HIGH, A port is the input and B port is the output. With T/ \bar{R} LOW, A port is the output and B port is the input.

Inputs	Conditions		
Chip Disable	0	0	1
Transmit/Receive	0	1	X
A Port	Out	In	HI-Z
B Port	In	Out	HI-Z

ABSOLUTE MAXIMUM RATINGS

Storage Temperature	-65°C to +150°C
Supply Voltage	+7.0V
Input Voltage	+5.5V
Output Voltage	+5.5V
Lead Temperature (Soldering, 10 seconds).....	300°C

Stresses above those listed under ABSOLUTE MAXIMUM RATINGS may cause permanent device failure. Functionality at or above these limits is not implied. Exposure to absolute maximum ratings for extended periods may affect device reliability.

OPERATING RANGES**Commercial (C) Devices**

Temperature	0°C to +70°C
Supply Voltage	+4.75V to +5.25V

Military (M) Devices

Temperature	-55°C to +125°C
Supply Voltage	+4.5V to +5.5V

Operating ranges define those limits over which the functionality of the device is guaranteed.

DC CHARACTERISTICS over operating range unless otherwise specified

Parameters	Description	Test Conditions	Min	Max	Units
V _C	Input Clamp Voltage	I _C = -5mA		-1	Volts
I _{CC}	Power Supply Current			8287	130
				8286	160
I _F	Forward Input Current	V _F = 0.45V		-0.2	mA
I _R	Reverse Input Current	V _R = 5.25V		50	μA
V _{OL} (COM'L)	Output Low Voltage	B Outputs	I _{OL} = 32mA		.45
		A Outputs	I _{OL} = 16mA		.45
V _{OL} (MIL)	Output Low Voltage	B Outputs	I _{OL} = 20mA		.45
		A Outputs	I _{OL} = 10mA		.45
V _{OH}	Output High Voltage	B Outputs	I _{OH} = -5mA	2.4	
		A Outputs	I _{OH} = -1mA	2.4	
I _{OFF}	Output Off Current		V _{OFF} = 0.45V		I _F
			V _{OFF} = 5.25V		I _R
V _{IL}	Input Low Voltage	A Port	V _{CC} = 5.0V (See note 1)		0.8
		B Port	V _{CC} = 5.0V (See note 1)		0.9
V _{IH}	Input High Voltage	V _{CC} = 5.0V (See note 1)	2.0		Volts
C _{IN}	Input Capacitance	F = 1MHz V _{BIAS} = 2.5V, V _{CC} = 5V T _A = 25°C		12	pF

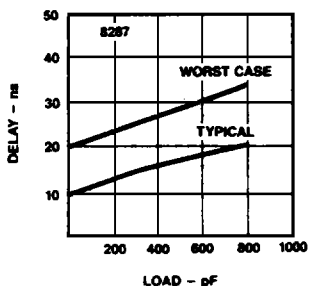
OPERATING CHARACTERISTICS**Output Delay versus Capacitance**

OP001240

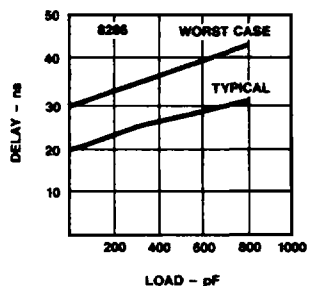

OP001250

SWITCHING TEST CIRCUITS

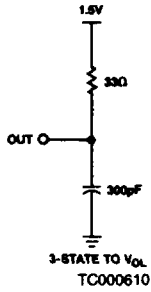

B OUTPUT

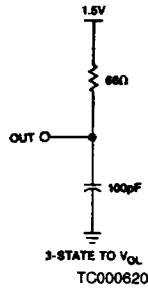

A OUTPUT

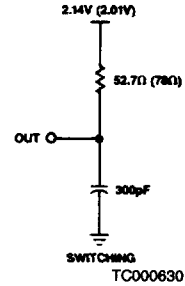

B OUTPUT

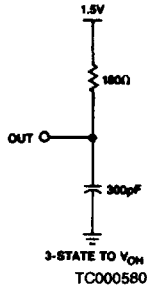

B OUTPUT

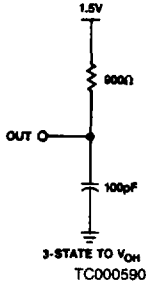

A OUTPUT

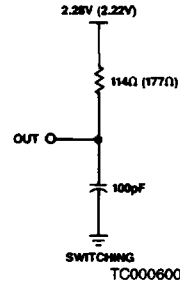

A OUTPUT

Values in parenthesis reflect MIL temp. conditions.

SWITCHING CHARACTERISTICS (See Note 2)

Parameters	Description	Test Conditions (See Notes)	Min (COM'L)	Min (MIL)	Max	Units
TIVOV	Input to Output Delay		5		22	ns
			5		30	
TEHTV	Transmit/Receive Hold Time		5	TENHOZ		ns
TTVEL	Transmit/Receive Setup		10	30		ns
TEHOZ	Output Disable Time		3		18	ns
TELOV	Output Enable Time		10	10	30	ns
TILH, TOLOH	Input, Output Rise Time	From 0.8 to 2.0V			20	ns
TIHL, TOHOL	Input, Output Fall Time	From 2.0 to 0.8V			12	ns

- Notes:
- COM'L temperature loading conditions
MIL temperature loading conditions
 - Refer to waveforms and SWITCHING TEST CIRCUITS on following pages.

B outputs: $I_{OL} = 32\text{mA}$, $I_{OH} = -5\text{mA}$, $C_L = 300\text{pF}$
A outputs: $I_{OL} = 16\text{mA}$, $I_{OH} = -1\text{mA}$, $C_L = 100\text{pF}$
B outputs: $I_L = 20\text{mA}$, $I_{OH} = -5\text{mA}$, $C_L = 300\text{pF}$
A outputs: $I_{OL} = 10\text{mA}$, $I_{OH} = -1\text{mA}$, $C_L = 100\text{pF}$

SWITCHING WAVEFORMS

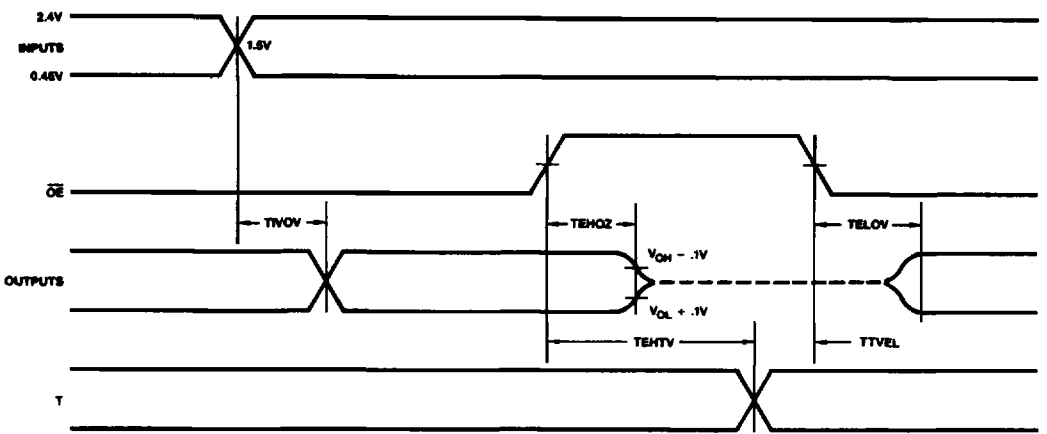

WF001910

AC testing inputs are driven at 2.4V for a logic "1" and 0.45V for a logic "0";
timing measurements are made at 1.5V for both a logic "1" and "0."