

T-33-13

2SD1399



2022

NPN Triple Diffused Planar Silicon Transistor

Color TV Horizontal Deflection Output Applications (with Damper Diode)

©1225C

Features:

- High Breakdown Voltage and High Reliability.
- High Switching Speed.
- Capable of being mounted easily due to one-point fixing type plastics mold package.

Absolute Maximum Ratings at Ta=25°C

			unit
Collector to Base Voltage	VCBO	1500	V
Collector to Emitter Voltage	VCEO	800	V
Emitter to Base Voltage	VEBO	7	V
Collector Current	IC	6	A
Peak Collector Current	icp	16	A
Collector Dissipation	PC	Tc=25°C	120 W
Junction Temperature	Tj	150	°C
Storage Temperature	Tstg	-55 to +150	°C

Electrical Characteristics at Ta=25°C

			min	typ	max	unit
Collector Cutoff Current	ICBO	VCB=800V, IE=0			10	uA
Emitter Cutoff Current	IEBO	VEB=4V, IC=0	40		130	mA
DC Current Gain	hFE	VCE=5V, IC=1A	8			
Gain Bandwidth Product	fT	VCE=10V, IC=1A		3		MHz
C-E Saturation Voltage	VCE(sat)	IC=5A, IB=1A			5	V
B-E Saturation Voltage	VBE(sat)	IC=5A, IB=1A			1.5	V
C-B Breakdown Voltage	V(BR)CBO	IC=5mA, IE=0	1500			V
C-E Breakdown Voltage	V(BR)CEO	IC=100mA, RBE=∞	800			V
E-B Breakdown Voltage	V(BR)EBO	IE=200mA, IC=0	7			V
Diode Forward Voltage	VF	IEC=6A			2	V
Fall Time	tf	IC=5A, IB1=1A, IB2=-2A VCC=200V, RL=40ohm			0.4	us

Switching Time Test Circuit

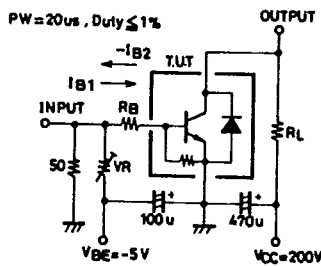

Case Outline 2022 (unit:mm)

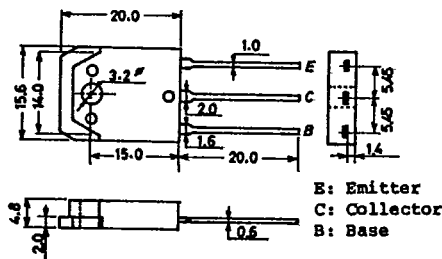

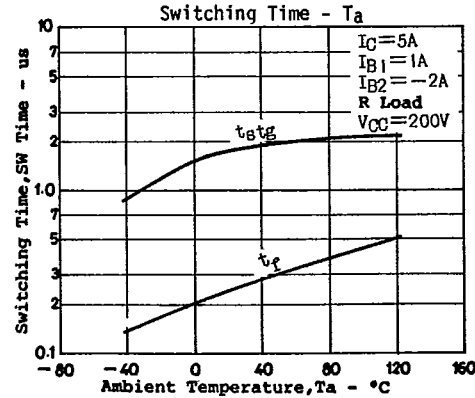
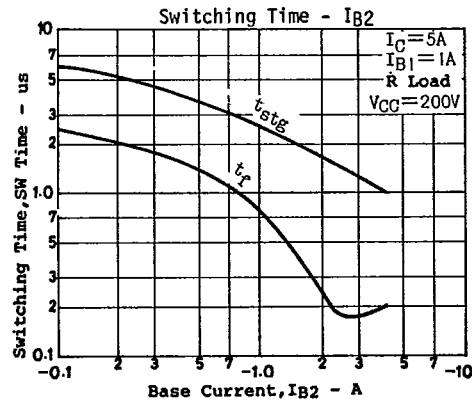
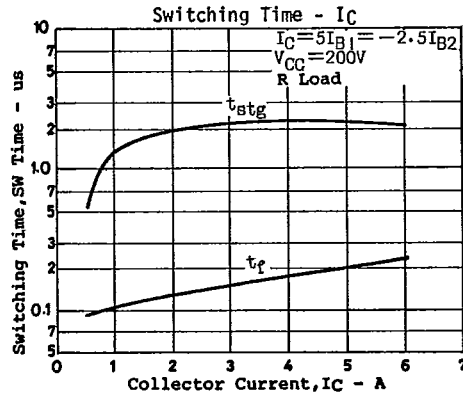
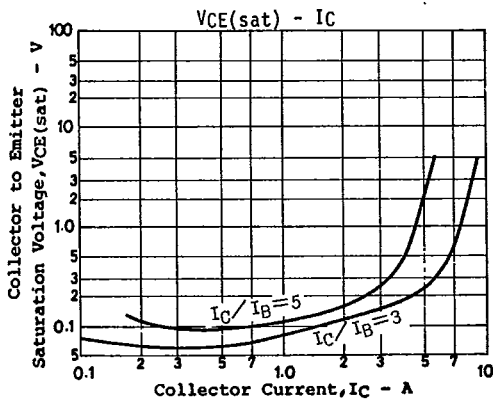
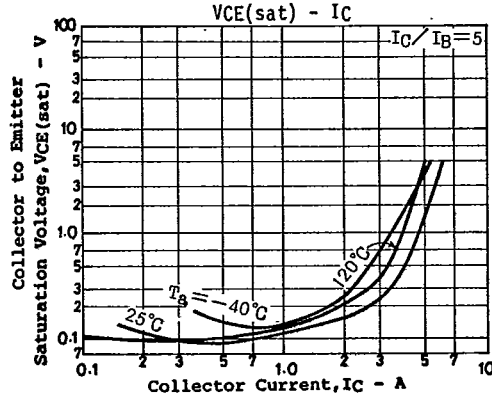
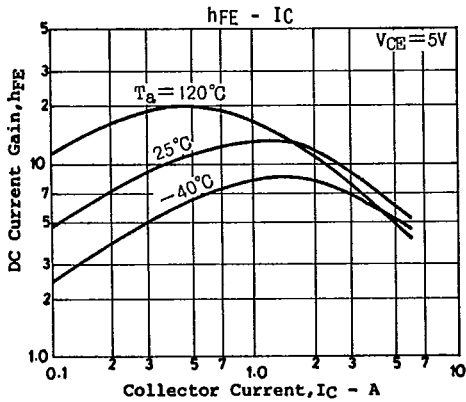
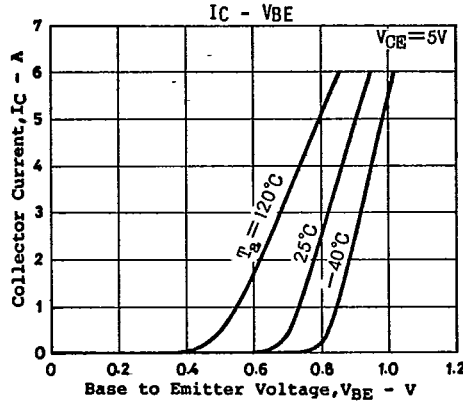
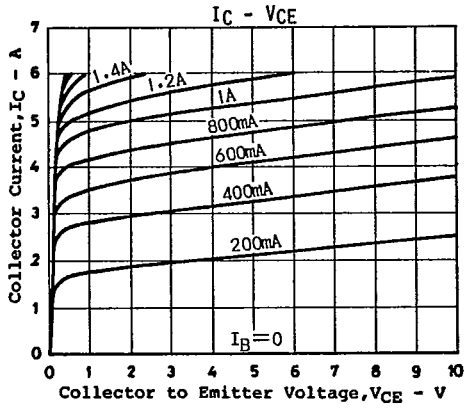

2SD1399

T-33-13

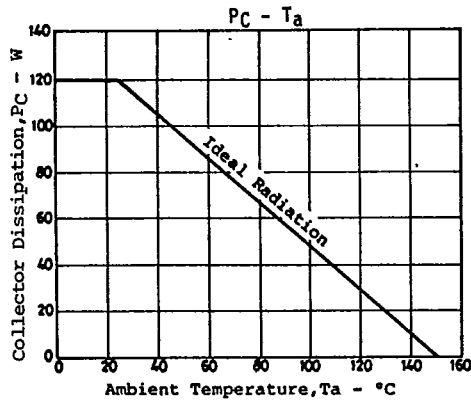
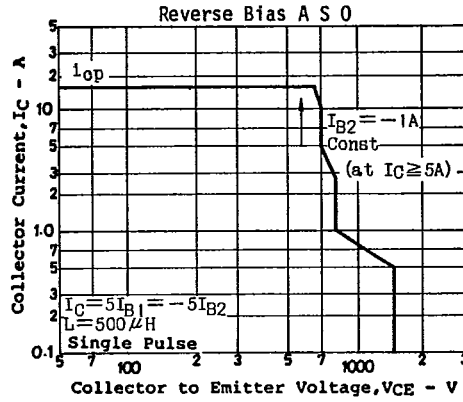
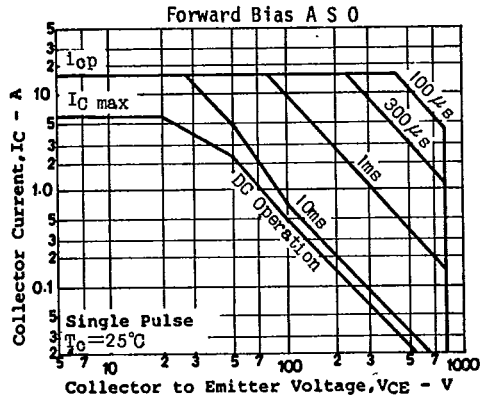

Sample Application Circuit

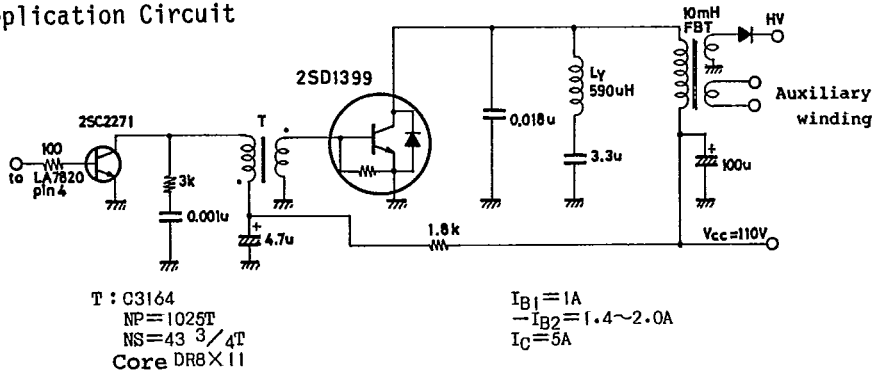

T-91-20

CASE OUTLINES AND ATTACHMENTS

- All of Sanyo Transistor case outlines are illustrated below.
- All dimensions are in mm, and dimensions which are not followed by min. or max. are represented by typical values.
- No marking is indicated.

Case Outline-[2003A]

unit:mm

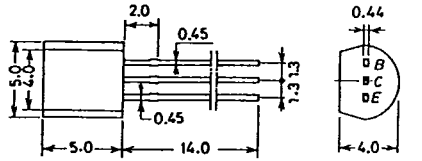

JEDEC: TO-92
EIAJ: SC-43
SANYO: NP

B. Base
C. Collector
E. Emitter

Case Outline-[2009A]

unit:mm

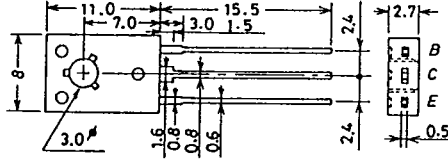

JEDEC: TO-126

B: Base
C: Collector
E: Emitter

Case Outline-[2004A]

unit:mm

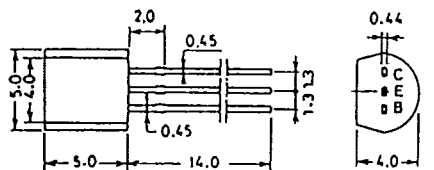

JEDEC: TO-92
EIAJ: SC-43
SANYO: NP

C. Collector
E. Emitter
B. Base

Case Outline-[2010A]

unit:mm

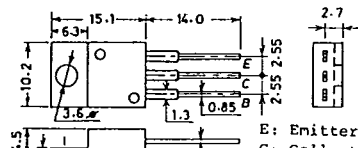

JEDEC: TO-220AB
EIAJ: SC-46

E: Emitter
C: Collector
B: Base

Case Outline-[2005A]

unit:mm

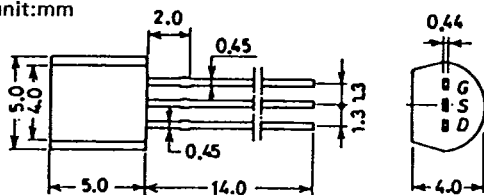

JEDEC: TO-92
EIAJ: SC-43
SANYO: NP

G: Gate
S: Source
D: Drain
B: Base
C: Collector

Case Outline-[2012]

unit:mm

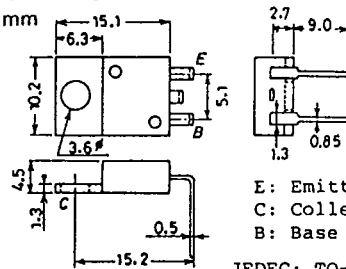

JEDEC: TO-220AA
EIAJ: SC-45

E: Emitter
C: Collector
B: Base

Case Outline-[2006A]

unit:mm

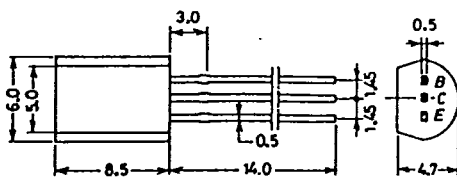

EIAJ: SC-51
SANYO: MP

B: Base
C: Collector
E: Emitter

Case Outline-[2013]

unit:mm

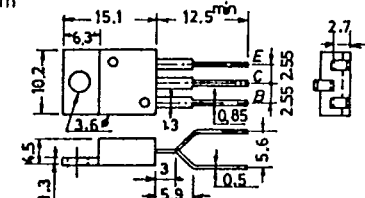

JEDEC TO-220

B: Base
C: Collector
E: Emitter

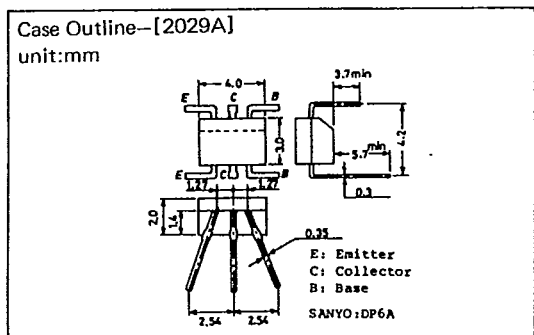
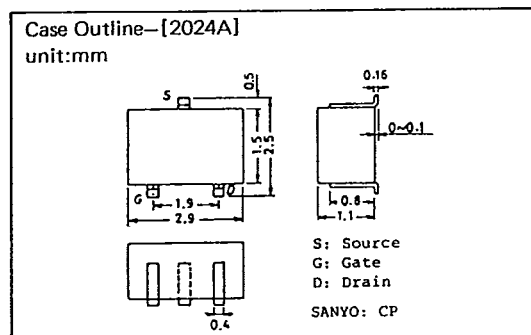
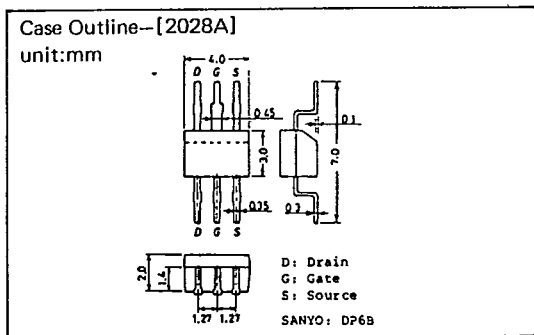
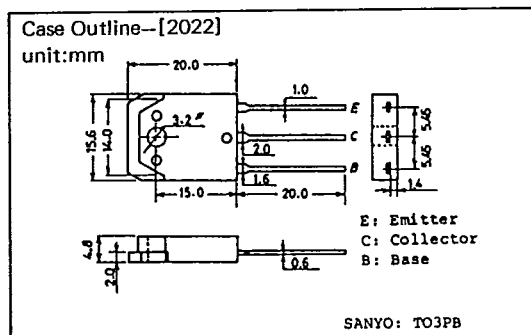
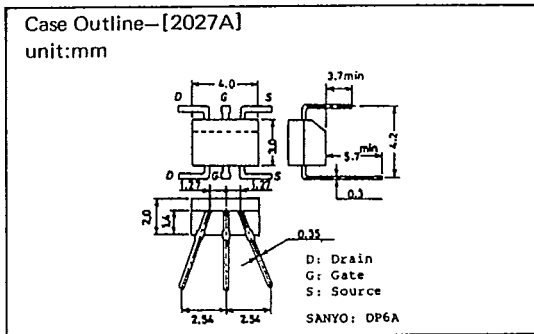
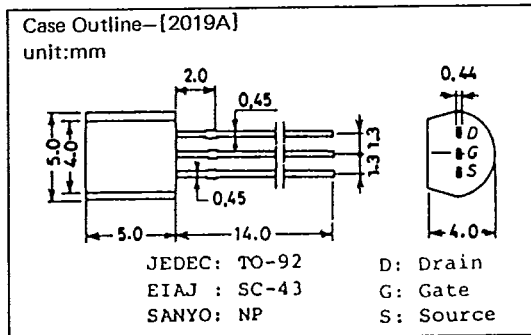
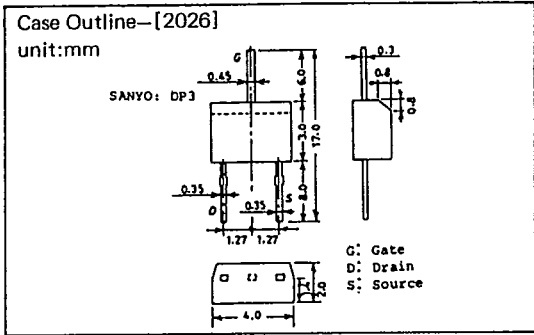
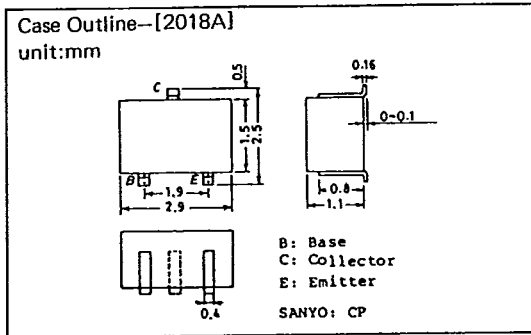
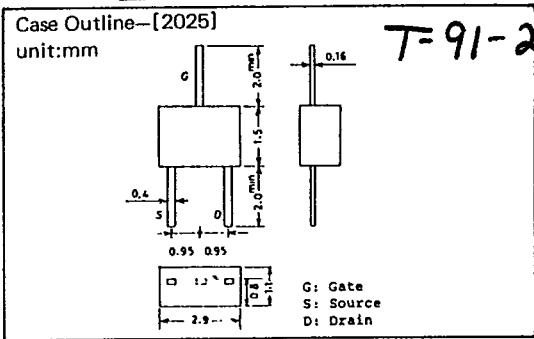
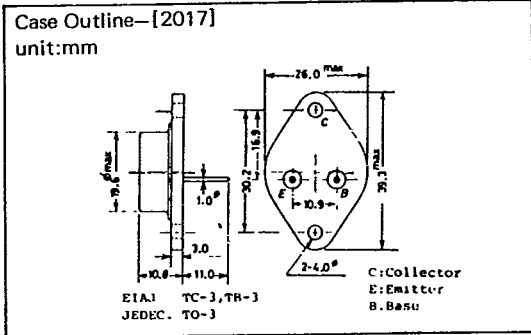

T-91-20

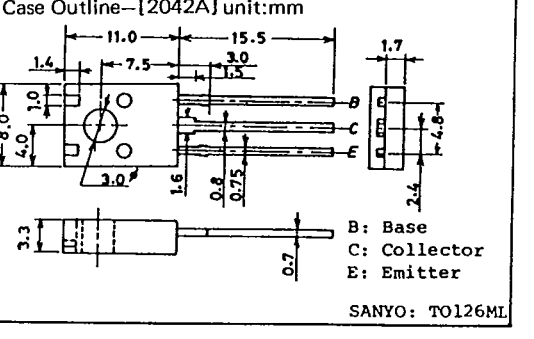
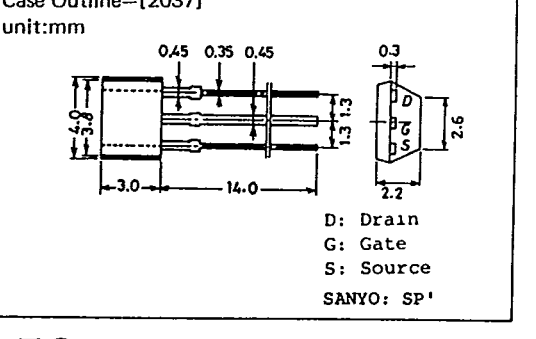
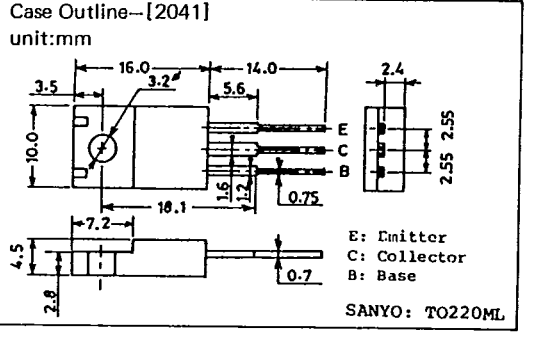
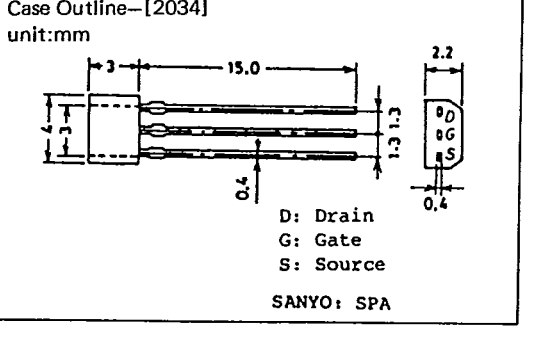
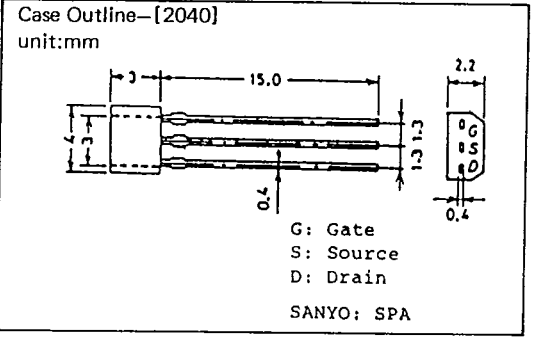
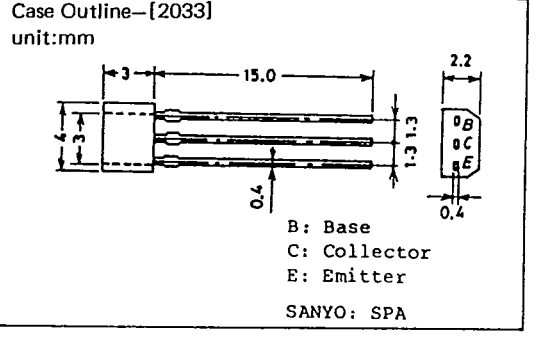
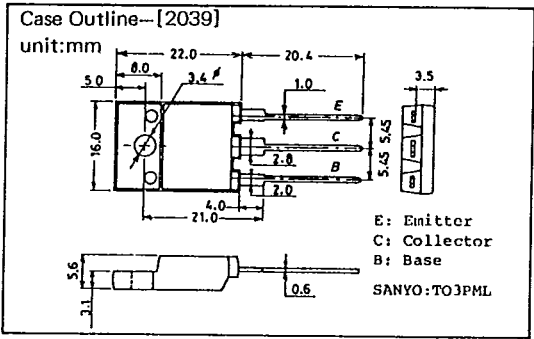
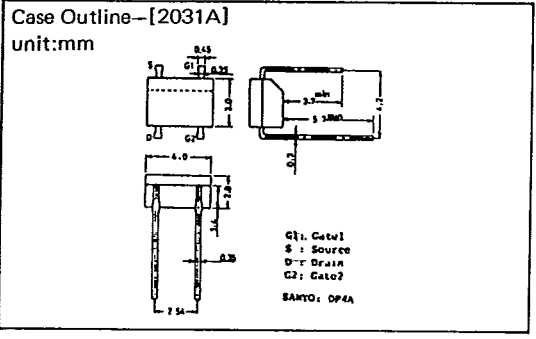
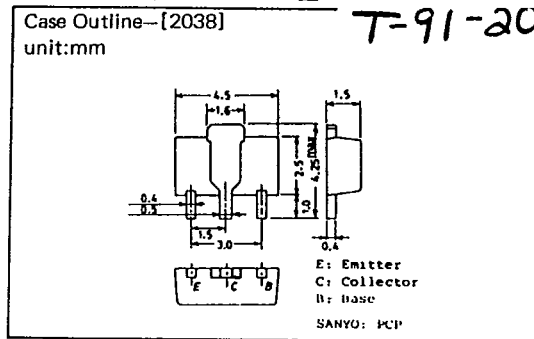
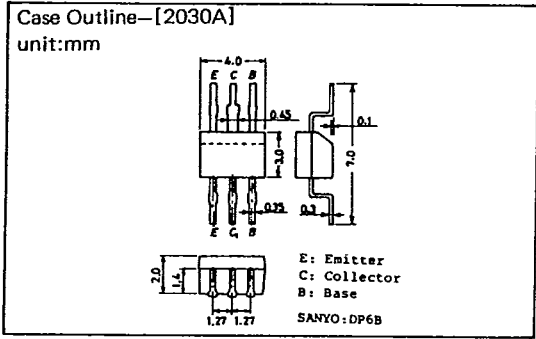

T-91-20

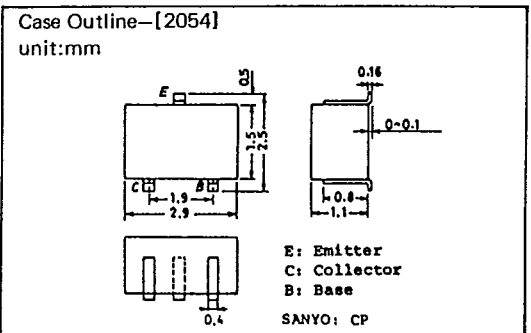
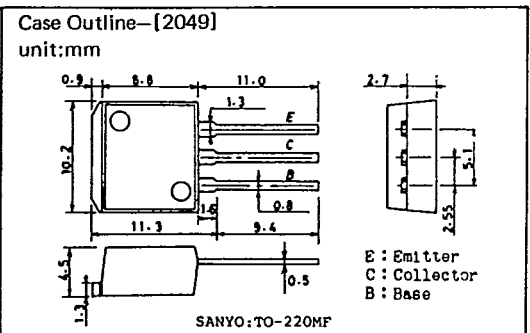
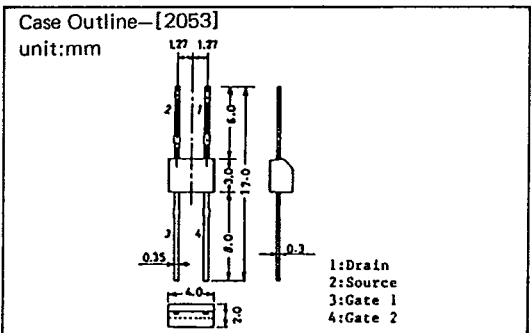
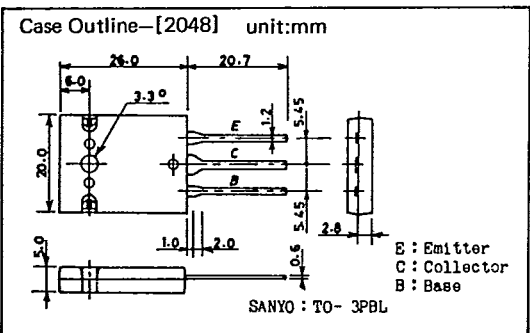
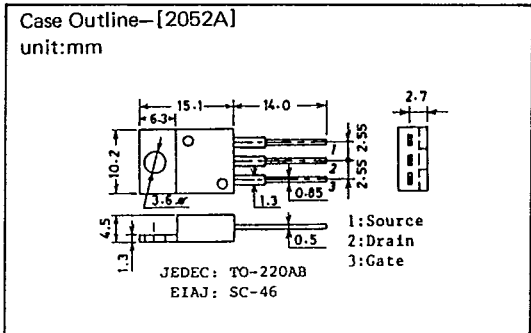
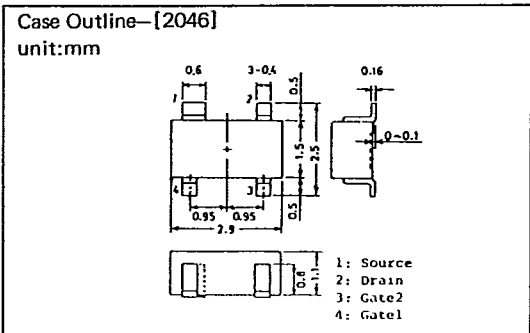
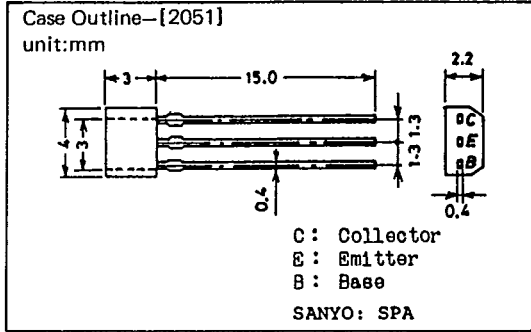
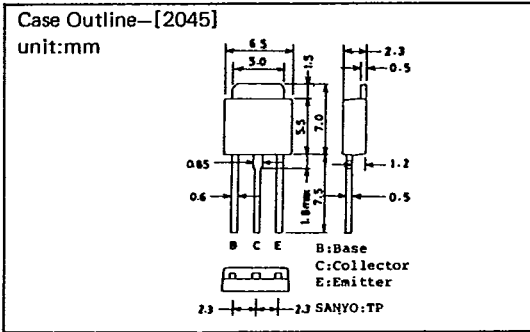
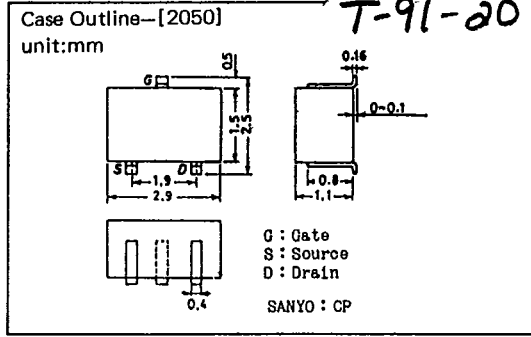
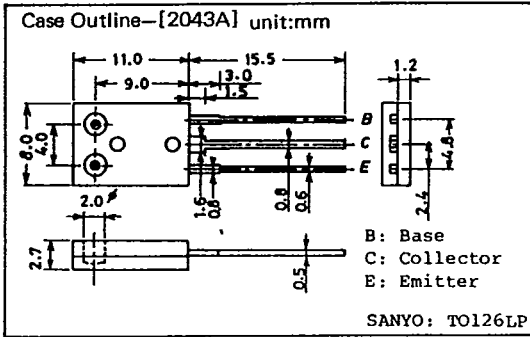

T-91-20

