

GaAlAs-Lumineszenzdiode

GaAlAs Infrared Emitter

SFH 460



Wesentliche Merkmale

- Hergestellt im Schmelzepitaxieverfahren
- Kathode galvanisch mit dem Gehäuseboden verbunden
- Hohe Zuverlässigkeit
- Gute spektrale Anpassung an Si-Fotoempfänger
- Hermetisch dichtes Metallgehäuse
- Gehäusegleich mit SFH 216, SFH 400 und SFH 480

Anwendungen

- Lichtschranken für Gleich- und Wechsellichtbetrieb
- IR-Gerätefernsteuerungen
- Sensorik
- Lichtgitter

Features

- Fabricated in a liquid phase epitaxy process
- Cathode is electrically connected to the case
- High reliability
- Matches all Si-Photodetectors
- Hermetically sealed package
- Same package as SFH 216, SFH 400 and SFH 480

Applications

- Photointerrupters
- IR remote control of various equipment
- Sensor technology
- Light-grille barrier

Typ Type	Bestellnummer Ordering Code	Gehäuse Package
SFH 460	Q62702-P478	18 A3 DIN 41876 (TO-18), Bodenplatte, Glaslinse, hermetisch dichtes Gehäuse, Anschlüsse im 2.54-mm-Raster ($1/10''$) 18 A3 DIN 41876 (TO -18), glass lens, hermetically sealed package, lead spacing 2.54 mm ($1/10''$)

Grenzwerte ($T_A = 25\text{ °C}$)**Maximum Ratings**

Bezeichnung Parameter	Symbol Symbol	Wert Value	Einheit Unit
Betriebs- und Lagertemperatur Operating and storage temperature range	$T_{op}; T_{stg}$	- 40 ... + 100	°C
Sperrspannung Reverse voltage	V_R	3	V
Durchlaßstrom Forward current	I_F	50	mA
Stoßstrom, $\tau = 10\ \mu\text{s}$, $D = 0$ Surge current	I_{FSM}	1	A
Verlustleistung Power dissipation	P_{tot}	120	mW
Wärmewiderstand Thermal resistance	R_{thJA} R_{thJC}	450 160	K/W K/W

Kennwerte ($T_A = 25\text{ °C}$)**Characteristics**

Bezeichnung Parameter	Symbol Symbol	Wert Value	Einheit Unit
Wellenlänge der Strahlung Wavelength at peak emission $I_F = 50\text{ mA}$, $t_p = 20\text{ ms}$	λ_{peak}	660	nm
Spektrale Bandbreite bei 50% von I_{max} Spectral bandwidth at 50% of I_{max} $I_F = 50\text{ mA}$	$\Delta\lambda$	25	nm
Abstrahlwinkel Half angle	φ	± 6	Grad deg.
Aktive Chipfläche Active chip area	A	0.106	mm ²
Abmessungen der aktiven Chipfläche Dimension of the active chip area	$L \times B$ $L \times W$	0.325×0.325	mm
Abstand Chipoberfläche bis Linsenscheitel Distance chip front to lens top	H	4.0 ... 4.8	mm
Schaltzeiten, I_e von 10% auf 90% und von 90% auf 10%, bei $I_F = 50\text{ mA}$, $R_L = 50\ \Omega$ Switching times, I_e from 10% to 90% and from 90% to 10%, $I_F = 50\text{ mA}$, $R_L = 50\ \Omega$	t_r , t_f	100	ns

Kennwerte ($T_A = 25\text{ °C}$)
Characteristics (cont'd)

Bezeichnung Parameter	Symbol Symbol	Wert Value	Einheit Unit
Kapazität, Capacitance $V_R = 0\text{ V}, f = 1\text{ MHz}$	C_o	30	pF
Durchlaßspannung, Forward voltage $I_F = 50\text{ mA}, t_p = 20\text{ ms}$	V_F	2.1 (≤ 2.8)	V
Sperrstrom, Reverse current $V_R = 3\text{ V}$	I_R	0.01 (≤ 10)	μA
Gesamtstrahlungsfluß, Total radiant flux $I_F = 50\text{ mA}, t_p = 20\text{ ms}$	Φ_e	4	mW
Temperaturkoeffizient von I_e bzw. Φ_e , $I_F = 50\text{ mA}$ Temperature coefficient of I_e or Φ_e , $I_F = 50\text{ mA}$	TC_I	- 0.4	%/K
Temperaturkoeffizient von V_F , $I_F = 50\text{ mA}$ Temperature coefficient of V_F , $I_F = 50\text{ mA}$	TC_V	- 3	mV/K
Temperaturkoeffizient von λ , $I_F = 50\text{ mA}$ Temperature coefficient of λ , $I_F = 50\text{ mA}$	TC_λ	+ 0.16	nm/K
Strahlstärke Radiant intensity $I_F = 50\text{ mA}, t_p = 20\text{ ms}$	$I_{e\text{ min}}$	16	mW/sr

Relative Spectral Emission

$I_{rel} = f(\lambda)$

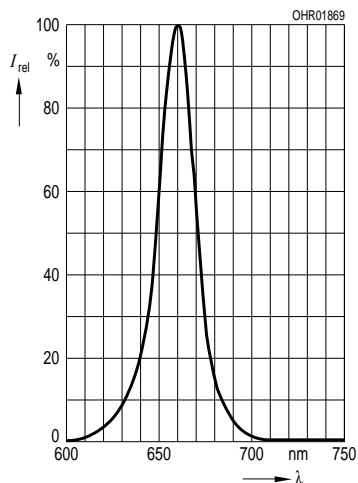

Forward Current

$I_F = f(V_F)$, single pulse, $\tau = 20 \mu s$

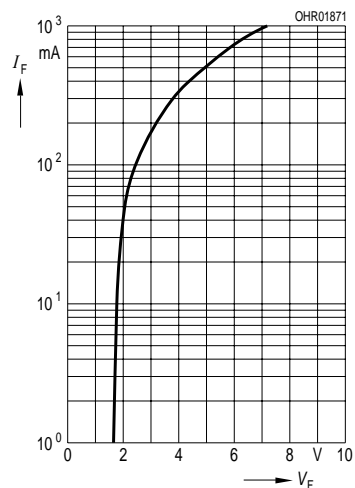

Directional Characteristics

$S_{rel} = f(\varphi)$

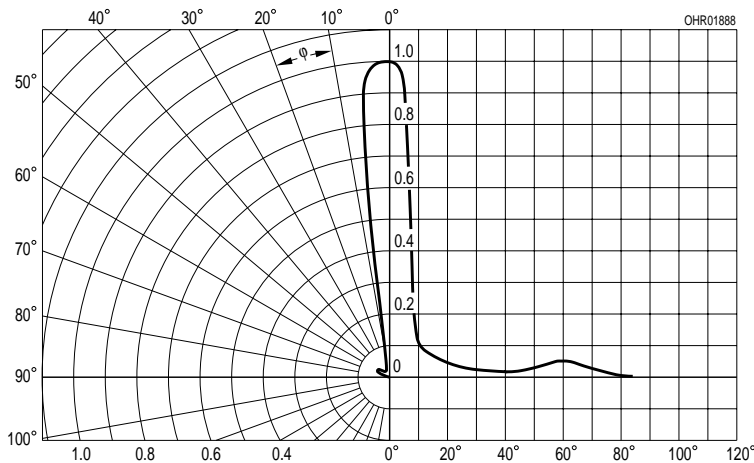

Radiant Intensity $\frac{I_e}{I_{e 50 mA}} = f(I_F)$

Single pulse, $\tau = 20 \mu s$

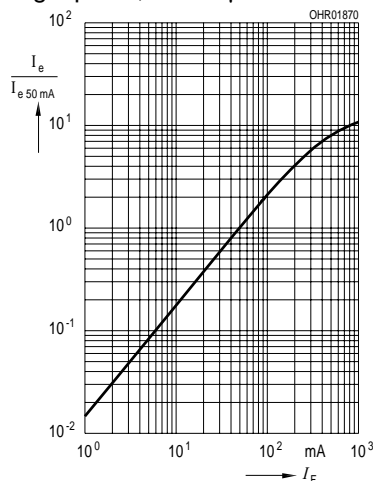

Permissible Pulse Handling Capability

$I_F = f(\tau)$, $T_C = 25 \text{ }^\circ\text{C}$, duty cycle $D = \text{parameter}$

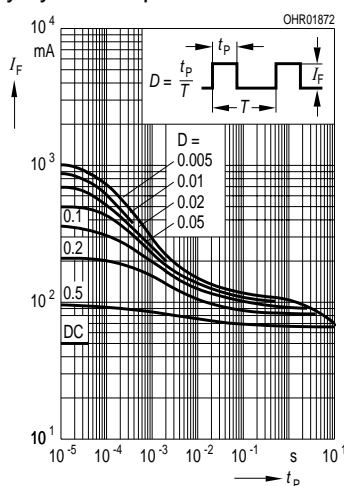

Max. Permissible Forward Current

$I_F = f(T_C)$, $R_{thJC} = 160 \text{ k/W}$ mounted on a heat sink

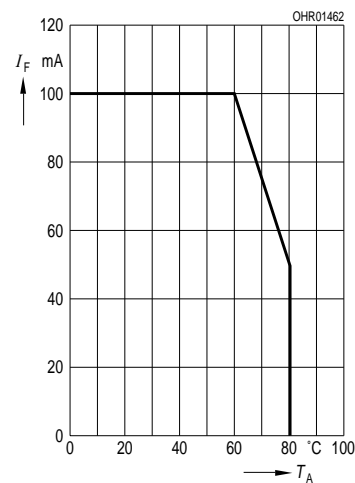

Max. Permissible Forward Current

$I_F = f(T_C)$, $R_{thJC} = 450 \text{ k/W}$

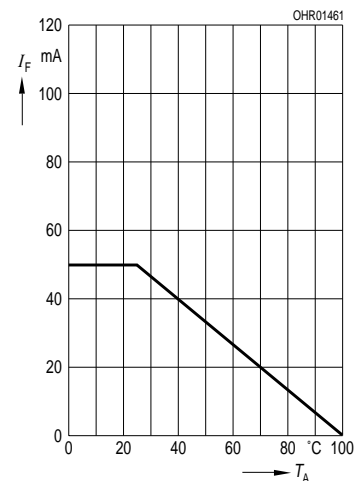

Maßzeichnung Package Outlines

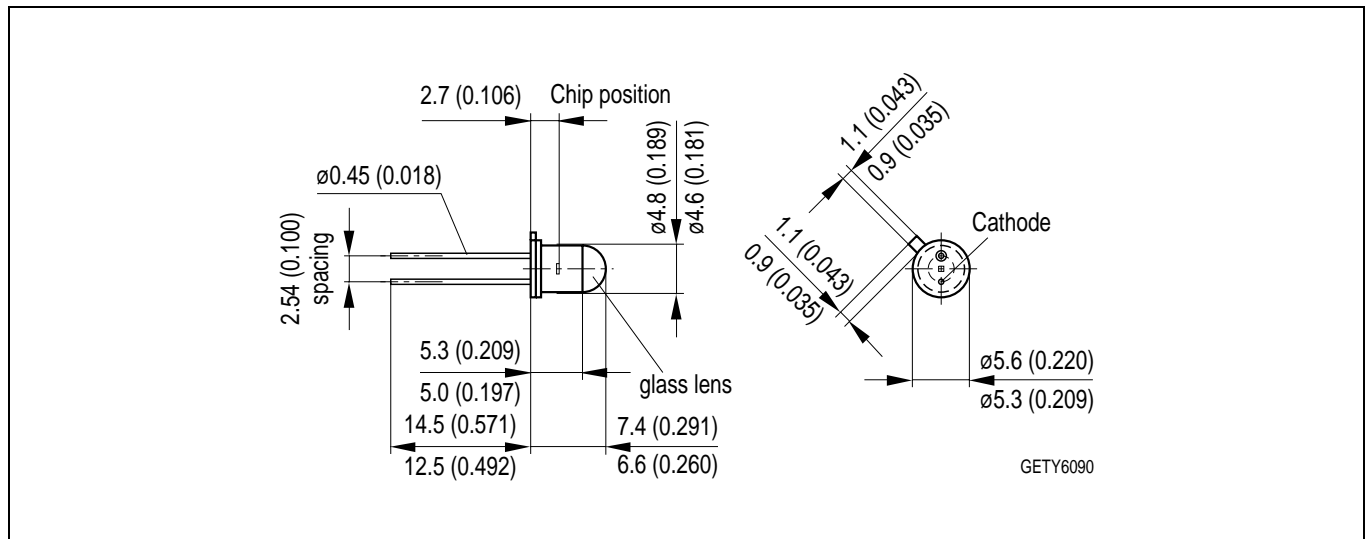

Maße werden wie folgt angegeben: mm (inch) / Dimensions are specified as follows: mm (inch).

Published by OSRAM Opto Semiconductors GmbH & Co. OHG
Wernerwerkstrasse 2, D-93049 Regensburg

© All Rights Reserved.

Attention please!

The information describes the type of component and shall not be considered as assured characteristics. Terms of delivery and rights to change design reserved. Due to technical requirements components may contain dangerous substances. For information on the types in question please contact our Sales Organization.

Packing

Please use the recycling operators known to you. We can also help you – get in touch with your nearest sales office. By agreement we will take packing material back, if it is sorted. You must bear the costs of transport. For packing material that is returned to us unsorted or which we are not obliged to accept, we shall have to invoice you for any costs incurred.

Components used in life-support devices or systems must be expressly authorized for such purpose! Critical components¹, may only be used in life-support devices or systems² with the express written approval of OSRAM OS.

¹ A critical component is a component used in a life-support device or system whose failure can reasonably be expected to cause the failure of that life-support device or system, or to affect its safety or effectiveness of that device or system.

² Life support devices or systems are intended (a) to be implanted in the human body, or (b) to support and/or maintain and sustain human life. If they fail, it is reasonable to assume that the health of the user may be endangered.