

8 K × 8 / 3.3 Volts Very Low Power CMOS SRAM

Introduction

The L65664 is a very low power CMOS static RAM organized as 8192 × 8 bits. It is manufactured using the TEMIC high performance SC MOS technology.

The L65664 provides fast access time of 55 ns for a 3 Volts power supply.

Utilising an array of six transistors (6T) memory cells, the L65664 combines an extremely low standby supply

current (typical value = 0.1 μA) with a fast access time of 55 ns. The high stability of the 6T cell provides excellent protection against soft errors due to noise.

Extra protection against heavy ions is given by the use of an epitaxial layer on a P substrate.

The L65664 is processed following the test methods of MIL STD 883.

Features

- Single supply 3.3 ± 0.3 volts
- Access time
 - Commercial : 55*/70/85 ns (max)
 - Military : 70*/85 ns (max)
- Very low power consumption
 - Active : 105 mW (typ)
 - Standby : 0.3 μW (typ)
 - Data retention : 0.2 μW (typ)
- Wide temperature range :
 - 55 °C to + 125 °C
- Asynchronous
- Equal cycle and access time
- Gated inputs : no pull-up/down resistors are required

* Preliminary.

Interface

Block Diagram

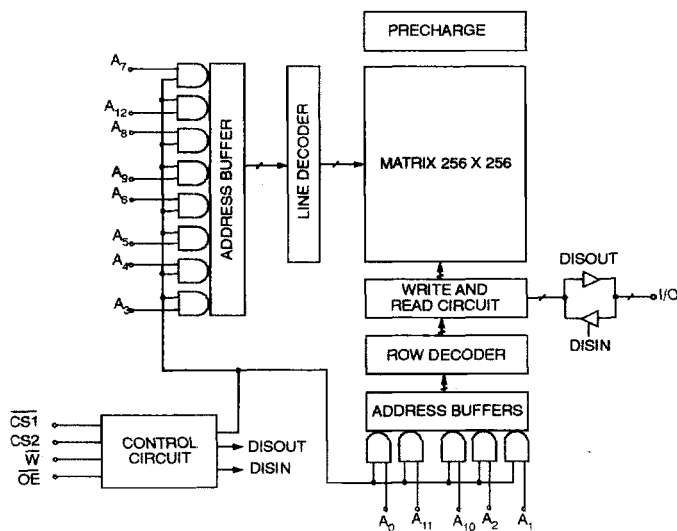

Pin Configuration

Pinout DIL/SO 28 pins (top view)

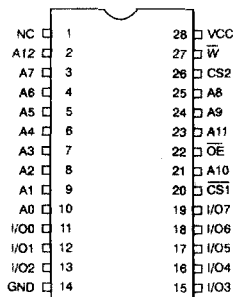

Pinout LCC 32 pins (top view)

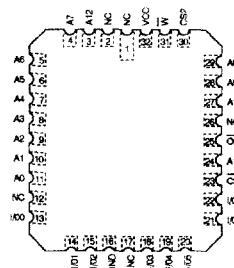

Pin Description

A0-A12	: Address inputs	$\overline{CS1}$: Chip-select 1
I/O0-I/O7	: Input/Output	CS2	: Chip-select 2
Vcc	: Power	\overline{OE}	: Output Enable
Gnd	: Ground	\overline{W}	: Write enable

Truth Table

CS1	CS2	OE	W	I/O0-I/O7	I/O0-I/O7	MODE
H	X	X	X	Z	Z	Deselect
L	H	L	H	Z	Valid	Read
L	H	X	L	Valid	Z	Write
L	H	H	H	Z	Z	Output disable

L = low, H = high, X = H or L, Z = high impedance.

Electrical Characteristics

Absolute Maximum Ratings

Supply voltage to GND potential : -0.5 V to + 7.0 V

Input or Output voltage applied : (Gnd - 0.3 V) to (Vcc + 0.3 V)

Storage temperature : -65 °C to + 150 °C

Operating Range

	Supply Voltage	Operating Temperature
Military	3.3 V ± 0.3 V	- 55 °C to + 125 °C
Industrial	3.3 V ± 0.3 V	- 40 °C to + 85 °C
Commercial	3.3 V ± 0.3 V	0 °C to + 70 °C

DC Operating Conditions

Symbol	Parameter	Min	Typ	Max	Unit
Vcc	Supply voltage	3	3.3	3.6	V
Gnd	Ground	0.0	0.0	0.0	V
VIL (1)	Input low voltage	- 0.3	0.0	0.6	V
VIH	Input high voltage	1.8	-	Vcc + 0.3 V	V

Note : 1. VIL min = -0.3 V or -1.0 V pulse width 50 ns.

1

Electrical Characteristics DC Parameter

PARAMETER	DESCRIPTION	MINIMUM	TYPICAL	MAXIMUM	UNIT
IIX (2)	Input leakage current	-1.0	-	1	μA
IOZ(2)	Output leakage current	-1.0	-	1.0	μA
VOL (3)	Output low voltage	-	-	0.4	V
VOH (3)	Output high voltage	2	-	-	V

Notes : 2. Gnd < Vin < Vcc, Gnd < Vout < Vcc Output disabled.
3. Vcc min, IOL = 1 mA, IOH = -0.5 mA.

Capacitance

PARAMETER	DESCRIPTION	MINIMUM	TYPICAL	MAXIMUM	UNIT
Cin (4)	Input capacitance	-	-	8	pF
Cout (4)	Output capacitance	-	-	8	pF

Note : 4. TA = 25°C, f = 1 MHz, Vcc = 5.0 V, these parameters are not tested.

Consumption for Commercial Specification

SYMBOL	PARAMETER	L-65664 V-55	L-65664 L-55	L-65664 V-70	L-65664 L-70	L-65664 V-85	L-65664 L-85	UNIT	VALUE
ICCSB (5)	Standby supply current	5	10	5	10	5	10	mA	max
ICCSB1 (6)	Standby supply current	0.7	40	0.7	40	0.7	40	μA	max
ICCOP (7)	Operating supply current	50	70	50	70	50	70	mA	max

Consumption for Industrial Specification

SYMBOL	PARAMETER	L-65664 V-70	L-65664 L-70	L-65664 V-75	L-65664 L-75	L-65664 V-85	L-65664 L-85	UNIT	VALUE
ICCSB (5)	Standby supply current	10	15	10	15	10	15	mA	max
ICCSB1 (6)	Standby supply current	3	50	3	50	3	50	μA	max
ICCOP (7)	Operating supply current	55	75	55	75	55	75	mA	max

Consumption for Military Specification

SYMBOL	PARAMETER	L-65664 V-70	L-65664 L-70	L-65664 V-85	L-65664 L-85	UNIT	VALUE
ICCSB (5)	Standby supply current	10	15	10	15	mA	max
ICCSB1 (6)	Standby supply current	30	300	30	300	μA	max
ICCOP (7)	Operating supply current	55	75	55	75	mA	max

Notes : 5. $\overline{CS1} \geq V_{IH}$, $CS2 \leq V_{IL}$, $V_{in} \geq V_{IH}$ or $V_{in} \leq V_{IL}$.
6. $\overline{CS1} \geq V_{cc} - 0.3$ V, $CS2 \leq 0.3$ V, $I_{out} = 0$ mA. $V_{in} \geq V_{cc} - 0.3$ V or $V_{in} \leq 0.3$ V.
7. Vcc max, $I_{out} = 0$ mA, $V_{in} = Gnd/V_{cc}$.
"For Low frequency application consult us."

Data Retention Mode

TEMIC CMOS RAM's are designed with battery backup in mind. Data retention voltage and supply current are guaranteed over temperature. The following rules insure data retention :

1. Chip select (\overline{CS}) must be held high during data retention ; within V_{CC} to $V_{CC} - 0.2$ V.
2. Output Enable (\overline{OE}) should be held high to keep the RAM outputs high impedance, minimizing power dissipation.
3. \overline{CS} and \overline{OE} must be kept between $V_{CC} + 0.3$ V and 70 % of V_{CC} during the power up and power down transitions.
4. The RAM can begin operation > 55 ns after V_{CC} reaches the minimum operating voltage (3 V).

Timing

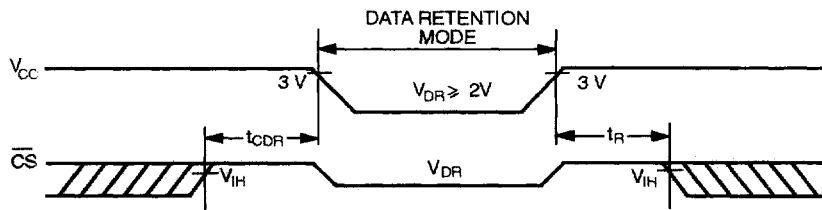

Data Retention Characteristics

PARAMETER	DESCRIPTION	MINIMUM	TYPICAL (9)	MAXIMUM			UNIT
VCCDR	V_{CC} for data retention	2.0	-	-			V
TCDR	Chip deselect to data retention time	0.0	-	-			ns
TR	Operation recovery time	TAVAV (9)	-	-			ns
ICCDR1 (10)	Data retention current			COM	IND	MIL	
	@ 2.0 V :						
	L-65664V-55	-	0.1	0.5	-	-	μ A
	L-65664L-55	-	0.1	30	-	-	μ A
	L-65664V-70/75/85	-	0.1	0.5	2	20	μ A
L-65664L-70/75/85	-	0.1	30	40	200	μ A	

- Notes :
8. $T_A = 25^\circ\text{C}$.
 9. TAVAV = Read cycle time.
 10. $\overline{CS} = V_{CC}$, $V_{in} = \text{Gnd}/V_{CC}$.

AC Parameters

AC Conditions :

Input pulse levels : Gnd to 3.0 V Input timing reference levels : 1.2 V
 Input rise : 5 ns Output load : See fig. 1a, 1b



Write Cycle : Commercial Specification (note 12)

SYMBOL	PARAMETER	I _{CS1} = 1.5V		I _{CS2} = 1.7V		I _{CS1} = 1.5V		UNIT	VALUE
		L-65664	L-65664	L-65664	L-65664	L-65664	L-65664		
TAVAV	Write cycle time	55	55	70	70	85	85	ns	min
TAVWL	Address set-up time	0	0	0	0	0	0	ns	min
TAVWH	Address valid to end of write	50	50	60	60	75	75	ns	min
TDVWH	Data set-up time	35	35	45	45	55	55	ns	min
TEL1WH	CS1 low to write end	50	50	60	60	75	75	ns	min
TEH2WH	CS2 low to write end	50	50	60	60	75	75	ns	min
TWLQZ (11)	Write low to high Z	25	25	25	25	30	30	ns	max
TWLWH	Write pulse width	50	50	65	65	80	80	ns	min
TWHAX	Address hold to end of write	2	2	2	2	2	2	ns	min
TWHDX	Data hold time	0	0	0	0	0	0	ns	min
TWHQX (11)	Write high to low Z	0	0	0	0	0	0	ns	min

Write Cycle : Industrial and Military Specification (note 12)

SYMBOL	PARAMETER	I _{CS1} = 1.7V		I _{CS1} = 1.7V		I _{CS1} = 1.5V		UNIT	VALUE
		L-65664	L-65664	L-65664	L-65664	L-65664	L-65664		
TAVAV	Write cycle time	70	70	75	75	85	85	ns	min
TAVWL	Address set-up time	0	0	0	0	0	0	ns	min
TAVWH	Address valid to end of write	60	60	65	65	75	75	ns	min
TDVWH	Data set-up time	45	45	50	50	55	55	ns	min
TEL1WH	CS1 low to write end	60	60	65	65	75	75	ns	min
TEH2WH	CS2 low to write end	60	60	65	65	75	75	ns	min
TWLQZ (11)	Write low to high Z	25	25	25	25	30	30	ns	max
TWLWH	Write pulse width	65	65	70	70	80	80	ns	min
TWHAX	Address hold to end of write	2	2	2	2	2	2	ns	min
TWHDX	Data hold time	0	0	0	0	0	0	ns	min
TWHQX (11)	Write high to low Z	0	0	0	0	0	0	ns	min

Write Cycle 1 : \overline{W} Controlled (note 12)

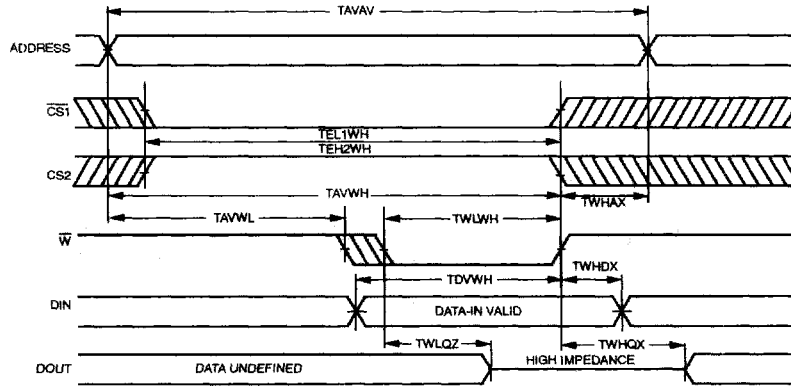

Write Cycle 2 : \overline{CS} Controlled (note 12)

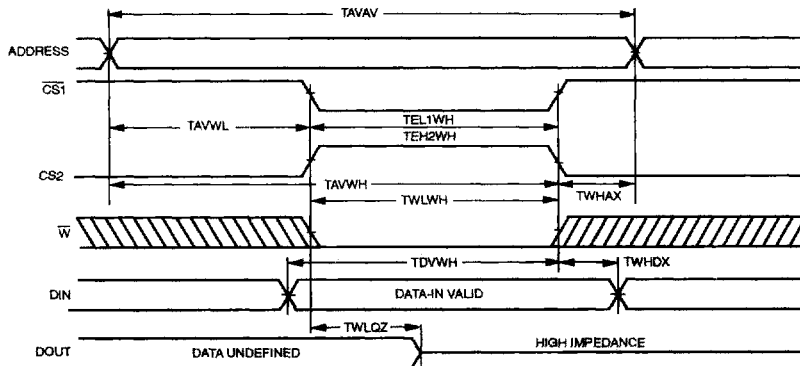

Note : 12. The internal write time of the memory is defined by the overlap of \overline{CS} LOW and \overline{W} LOW. Both signals must be LOW to initiate a write and either signal can terminate a write by going HIGH. The data input setup and hold timing should be referenced to the rising edge of the signal that terminates the write. Data out is high impedance if $\overline{OE} = V_{IH}$.

AC Test Loads and Waveforms

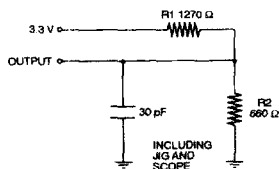

Figure 1 a

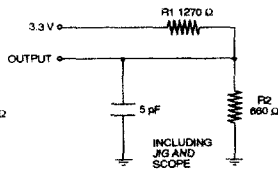

Figure 1 b

Equivalent to : THEVENIN EQUIVALENT

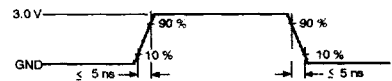
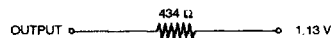

Figure 2

Read Cycle : Commercial Specification

SYMBOL	PARAMETER	V _{DD} = 1.8V	V _{DD} = 2.0V	V _{DD} = 2.5V	V _{DD} = 3.0V	V _{DD} = 3.3V	V _{DD} = 3.6V	UNIT	VALUE
TAVAV	Write cycle time	55	55	70	70	85	85	ns	min
TAVQV	Address access time	55	55	70	70	85	85	ns	max
TAVQX	Address valid to low Z	5	5	5	5	5	5	ns	min
TEL1QV	Chip-select 1 access time	55	55	70	70	85	85	ns	max
TEH2QV	Chip-select 2 access time	55	55	70	70	85	85	ns	max
TEL1QX (13)	$\overline{CS1}$ low to low Z	5	5	5	5	5	5	ns	min
TEH2QX (13)	CS2 to low Z	5	5	5	5	5	5	ns	min
TEH1QZ (13)	$\overline{CS1}$ high to high Z	35	35	45	45	55	55	ns	max
TEL2QZ (13)	CS2 low to high Z	35	35	45	45	55	55	ns	max
TGLQV	Output Enable access time	25	25	30	30	40	40	ns	max
TGLQX (13)	\overline{OE} low to low Z	5	5	5	5	5	5	ns	min
TGHQZ (13)	\overline{OE} high to high Z	25	25	30	30	40	40	ns	max

Read Cycle : Industrial and Military Specification

SYMBOL	PARAMETER	V _{DD} = 1.8V	V _{DD} = 2.0V	V _{DD} = 2.5V	V _{DD} = 3.0V	UNIT	VALUE
TAVAV	Read cycle time	70	70	85	85	ns	min
TAVQV	Address access time	70	70	85	85	ns	max
TAVQX	Address valid to low Z	5	5	5	5	ns	min
TEL1QV	Chip-select 1 access time	70	70	85	85	ns	max
TEH2QV	Chip-select 2 access time	70	70	85	85	ns	max
TEL1QX (13)	$\overline{CS1}$ low to low Z	5	5	5	5	ns	min
TEH2QX (13)	CS2 high to low Z	5	5	5	5	ns	min
TEH1QZ (13)	$\overline{CS1}$ high to high Z	45	45	55	55	ns	max
TEL2QZ (13)	CS2 low to high Z	45	45	55	55	ns	max
TGLQV	Output Enable access time	30	30	40	40	ns	max
TGLQX (13)	\overline{OE} low to low Z	5	5	5	5	ns	min
TGHQZ (13)	\overline{OE} high to high Z	30	30	40	40	ns	max

Note : 13. Guaranteed but not tested.

Read Cycle nb 1 (notes 14, 15)

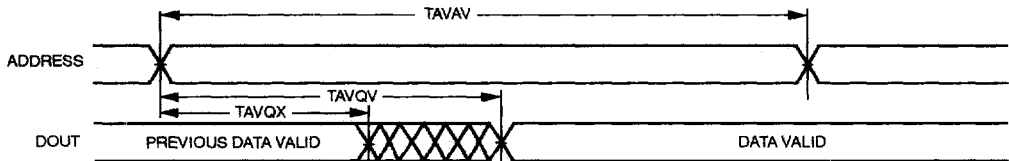

Read Cycle nb 2 (notes 14, 16)

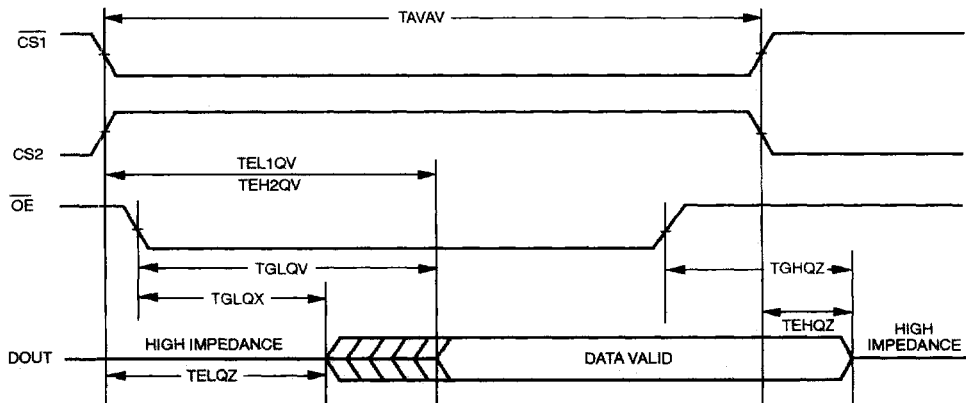

- Notes :
- 14. \overline{W} is high for read cycle.
 - 15. Device is continuously selected, $\overline{CS1}$ & $\overline{OE} = V_{IL}$ and $CS2 = V_{IH}$.
 - 16. Address valid prior to or coincident with \overline{CS} transition low.

Ordering Information

TEMPERATURE RANGE	PACKAGE	DEVICE	GRADE	SPEED	FLOW
C	L	3P	65664	L	- 70
	Low Voltage 3 ≤ V _{cc} ≤ 3.6 V		65664 8K × 8 Ultimate CMOS Static RAM		
C = Commercial I = Industrial M = Military S = Space	0° to +70°C -40° to +85°C -55° to +125°C			70 85	
	0 - Chip form 1 - Ceramic 28 pins 300 mils 1E - Ceramic 28 pins 600 mils 3P - Plastic 28 pins 300 mils 3I - Plastic 28 pins 600 mils 4 - LCC 32 pins TI - SOIC 300 mils 28 pins TP - SOIC 330 mils 28 pins UI - SOJ 28 pins C = Side brazed 28 pins 300 mils CE = Side brazed 28 pins 400 mils D = Flat pack 28 pins 400 mils				blank = MHS standards /883 = MIL STD 883 Class B or S P883 = MIL STD 883 + PIND test SB/SC = SCC 9000 level B/C SHXXX = Special customer request FHXXX = Flight models (space) EHXXX = Engineering models (space) MHXXX = Mechanical parts (space) LHXXX = Life test parts (space) : R = Tape and reel : RD = Tape and reel dry pack : D = Dry pack
			V = Very low power L = Low power		

1

Military and Space Versions

The following table gives package/consumption/access time/process flow available combinations

Temp. range	Package	Consumption		Access Time (ns)		Std process flow	RT process flow
		V	L	70	85	Mil flows	
M	1 1E 4 D 0	• • • X X	• • • X •	• • • X X	• • • X •	• • • X •	
S	C CE 4 D 0	• • • X X	• • • • •	• • • X X	• • • X •		• • • X •

• = product in production

X = call sales office for availability

The information contained herein is subject to change without notice. No responsibility is assumed by TEMIC for using this publication and/or circuits described herein; nor for any possible infringements of patents or other rights of third parties which may result from its use.