



LMV358

LINEAR INTEGRATED CIRCUIT

GENERAL PURPOSE, LOW VOLTAGE, RAIL-TO-RAIL OUTPUT OPERATIONAL AMPLIFIERS

DESCRIPTION

The UTC **LMV358** is the dual commodity op amp with low voltage (2.7-5.5V) versions, LM358, which operate at 5-30V. The UTC **LMV358** offers specifications that meet or exceed the familiar LM358 and is the most cost effective solution for the applications where low voltage operation, space saving and low price are needed. The UTC **LMV358** has rail-to-rail output swing capability and the input common-mode voltage range includes ground. Besides, it exhibits excellent speed-power ratio, achieving 1MHz of bandwidth and 1V/ μ s of slew rate.

The UTC **LMV358** has bipolar input and output stages for improved noise performance and higher output current drive.

FEATURES

(For $V^+ = 5V$ and $V^- = 0V$. Typical Unless Otherwise Noted)

*Guaranteed 2.7V and 5V Performance

*No Crossover Distortion

*Gain-Bandwidth Product: 1MHz

*Rail-to-Rail Output Swing

@10k Ω Load $V^+ - 10mV$
 $V^- + 65mV$

* V_{CM} -0.2V to $V^+ - 0.8V$

ORDERING INFORMATION

Normal	Ordering Number		Package	Packing
	Lead Free Plating	Halogen Free		
LMV358-D08-T	LMV358L-D08-T	LMV358G-D08-T	DIP-8	Tube
LMV358-S08-R	LMV358L-S08-R	LMV358G-S08-R	SOP-8	Tape Reel
LMV358-SM1-R	LMV358L-SM1-R	LMV358G-SM1-R	MSOP-8	Tape Reel
LMV358-P08-R	LMV358L-P08-R	LMV358G-P08-R	TSSOP-8	Tape Reel

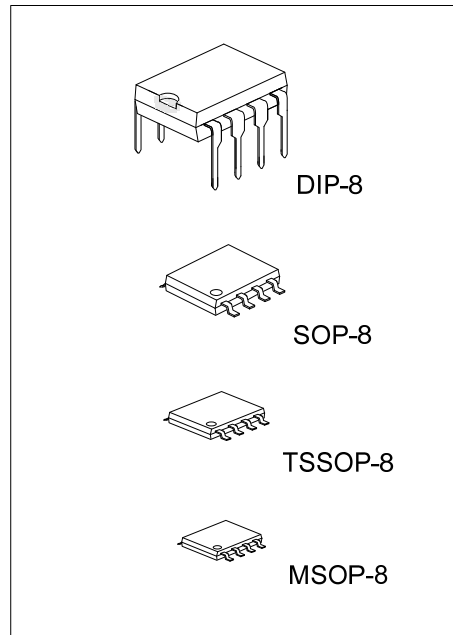

Lead-free: LMV358L
 Halogen-free: LMV358G

<p>LMV358L-D08-T</p> <p>(1) Packing Type (2) Package Type (3) Lead Plating</p>	<p>(1) R: Tape Reel, T: Tube (2) D08: DIP-8, S08: SOP-8, SM1: MSOP-8, P08: TSSOP-8 (3) G: Halogen Free, L: Lead Free, Blank: Pb/Sn</p>
--	--

■ PIN CONFIGURATION

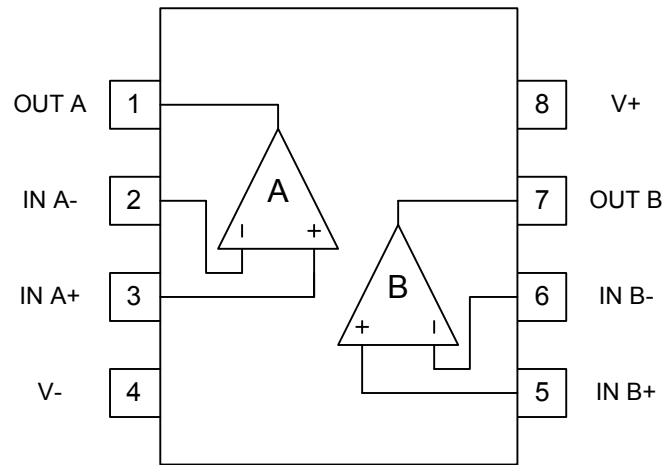

■ ABSOLUTE MAXIMUM RATINGS

PARAMETER	SYMBOL	RATINGS	UNIT
Supply Voltage	V _{SS}	2.7 ~ 5.5	V
Supply Voltage (V ⁺ - V ⁻)	V _{SS}	5.5	V
Differential Input Voltage	V _{I(DIFF)}	±Supply Voltage	
Output Short Circuit to V ⁺		(Note 2)	
Output Short Circuit to V ⁻		(Note 3)	
Infrared (15 sec)		215	°C
Junction Temperature (Note 4)	T _J	+150	°C
Operation Temperature	T _{OPR}	-40~+85	°C
Storage Temperature	T _{STG}	-65~+150	°C

Notes: 1. Absolute maximum ratings are those values beyond which the device could be permanently damaged.

Absolute maximum ratings are stress ratings only and functional device operation is not implied.

2. Shorting output to V⁺ will adversely affect reliability

3. Shorting output to V⁻ will adversely affect reliability

4. The maximum power dissipation is a function of T_{J(max)}, θ_{JA} and T_A. The maximum allowable power dissipation at any ambient temperature is P_D=(T_{J(max)}-T_A)/θ_{JA}. All numbers apply for packages soldered directly into a PC board.

■ THERMAL DATA

PARAMETER	SYMBOL	RATINGS	UNIT
Thermal Resistance (Note)	DIP-8	130	°C/W
	SOP-8	190	°C/W
	MSOP-8	235	°C/W
	TSSOP-8	155	°C/W

Note: All numbers are typical, and apply for packages soldered directly to a PC board is still air.

■ 2.7V ELECTRICAL CHARACTERISTICS

All limits guaranteed for T_J =25°C, V⁺=2.7V, V⁻=0V, V_{CM}=1.0V, V_{OUT} =V⁺/2 and R_L>1MΩ, unless otherwise specified.

PARAMETER	SYMBOL	CONDITIONS	MIN	TYP	MAX	UNIT
DC CHARACTERISTICS						
Input Offset Voltage	V _{OS}			1.7	7	mV
Input Offset Voltage Average Drift	TCV _{OS}			5		μV/°C
Input Bias Current	I _{I(BIAS)}			11	250	nA
Input Offset Current	I _{I(OFF)}			5	50	nA
Common Mode Rejection Ratio	CMRR	0V ≤ V _{CM} ≤ 1.7V	50	63		dB
Power Supply Rejection Ratio	PSRR	2.7V ≤ V ⁺ ≤ 5V V _{OUT} = 1V	50	60		dB
Input Common-Mode Voltage Range	V _{CM}	For CMRR ≥ 50dB	0	-0.2		V
				1.9	1.7	V
Output Swing	V _{OUT}	R _L = 10kΩ to 1.35V	V ⁺ - 100	V ⁺ - 10		mV
				60	180	mV
Supply Current	I _{SS}	Both amplifiers		1.2	1.7	mA
AC CHARACTERISTICS						
Gain-Bandwidth Product	GBWP	C _L = 200pF		1		MHz
Phase Margin	Φ _m			60		Deg
Gain Margin	G _m			10		dB
Input-Referred Voltage Noise	e _N	F = 1kHz		46		$\frac{nV}{\sqrt{Hz}}$
Input-referred Current Noise	i _n	F = 1kHz		0.17		$\frac{pA}{\sqrt{Hz}}$

■ 5V ELECTRICAL CHARACTERISTICS

All limits guaranteed for $T_J = 25^\circ\text{C}$, $V^+ = 5\text{V}$, $V^- = 0\text{V}$, $V_{CM} = 2.0\text{V}$, $V_{OUT} = V^+/2$ and $R_L > 1\text{M}\Omega$, unless otherwise specified.

PARAMETER	SYMBOL	CONDITIONS	MIN	TYP	MAX	UNIT	
DC CHARACTERISTICS							
Input Offset Voltage	V_{OS}			1.7	7	mV	
Input Offset Voltage Average Drift	TCVos			5		$\mu\text{V}/^\circ\text{C}$	
Input Bias Current	$I_{I(BIAS)}$			15	250	nA	
Input Offset Current	$I_{I(OFF)}$			5	50	nA	
Common Mode Rejection Ratio	CMRR	$0\text{V} \leq V_{CM} \leq 4\text{V}$	50	65		dB	
Power Supply Rejection Ratio	PSRR	$2.7\text{V} \leq V^+ \leq 5\text{V}$ $V_{OUT} = 1\text{V}$ $V_{CM} = 1\text{V}$	50	60		dB	
Input Common-Mode Voltage Range	V_{CM}	For CMRR $\geq 50\text{dB}$	0	-0.2		V	
				4	4.2	V	
Large Signal Voltage Gain(Note 1)	G_V	$R_L = 2\text{k}\Omega$	15	100		V/mV	
Output Swing	V_{OUT}	$R_L = 2\text{k}\Omega \sim 2.5\text{V}$	V_{OH}	$V^+ - 300$	$V^+ - 40$		mV
			V_{OL}		120	300	mV
		$R_L = 10\text{k}\Omega \sim 2.5\text{V}$	V_{OH}	$V^+ - 100$	$V^+ - 10$		mV
			V_{OL}		65	180	mV
Output Short Circuit Current	I_{OUT}	Sourcing, $V_{OUT} = 0\text{V}$	5	60		mA	
		Sinking, $V_{OUT} = 5\text{V}$	10	160		mA	
Supply Current	I_{SS}	Both amplifiers		1.5	2.0	mA	
AC CHARACTERISTICS							
Slew Rate	SR	(Note 2)		1		V/ μs	
Gain-Bandwidth Product	GBWP	$C_L = 200\text{pF}$		1		MHz	
Phase Margin	Φ_m			60		Deg	
Gain Margin	G_m			10		dB	
Input-Referred Voltage Noise	eN	$f = 1\text{kHz}$		39		$\frac{\text{nV}}{\sqrt{\text{Hz}}}$	
Input-referred Current Noise	i_n	$f = 1\text{kHz}$		0.21		$\frac{\text{pA}}{\sqrt{\text{Hz}}}$	

Notes: 1. R_L is connected to V^- . The output voltage is $0.5\text{V} \leq V_{OUT} \leq 4.5\text{V}$.

2. Connected as voltage follower with 3V step input. Number specified is these lower of the positive and negative slew rates.

■ TYPICAL CHARACTERISTICS

(Unless otherwise specified, $V_E=+5V$, single supply. $T_A=25^\circ C$)

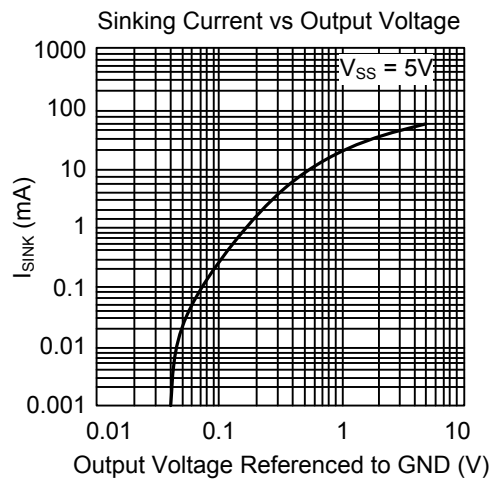
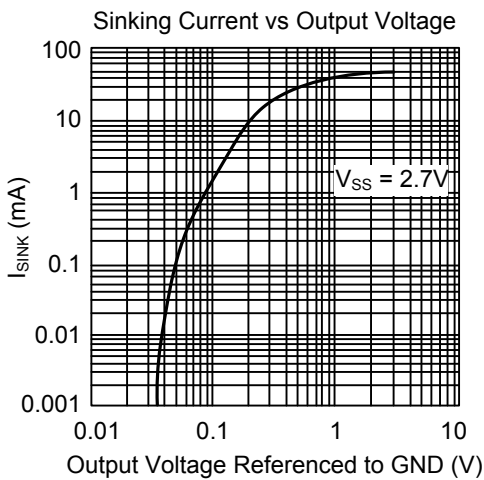
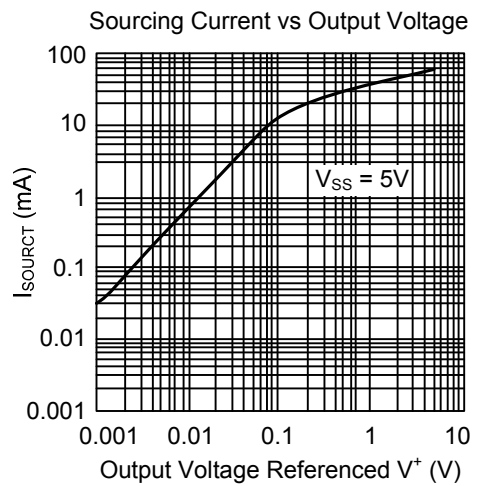
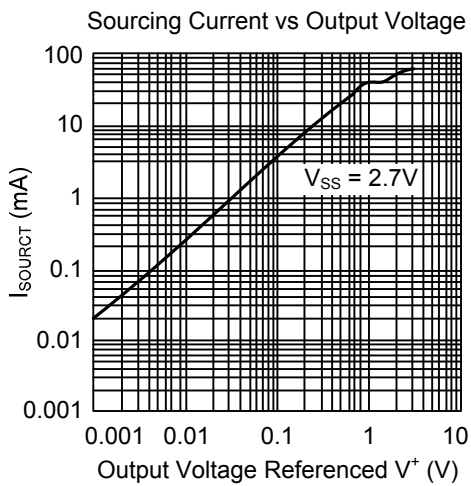
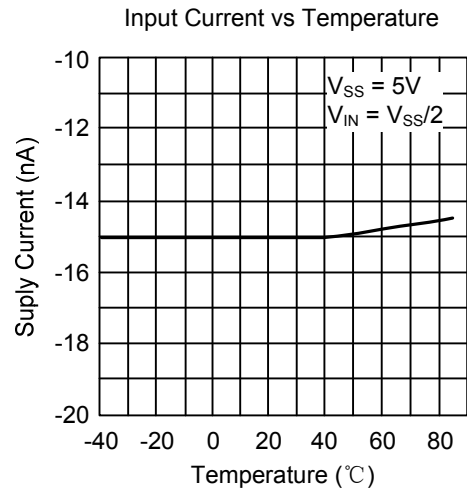
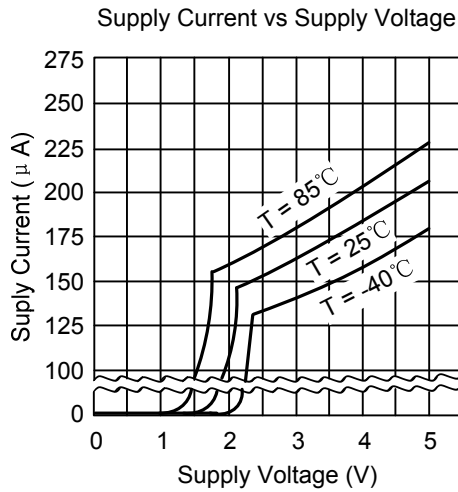

■ TYPICAL CHARACTERISTICS(Cont.)

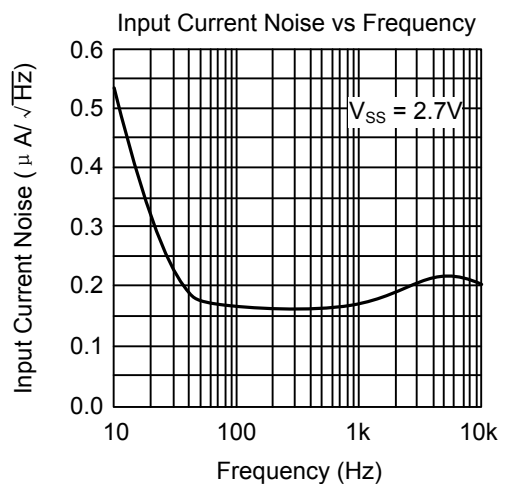
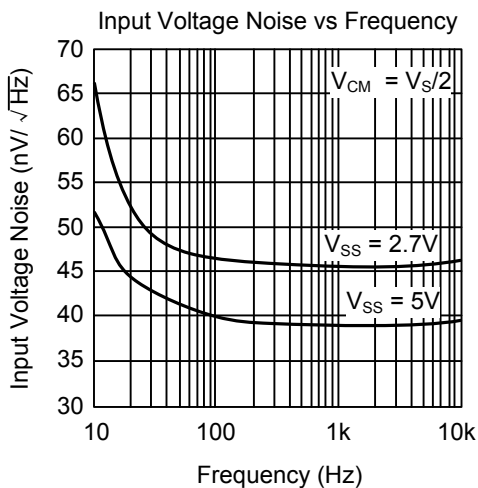
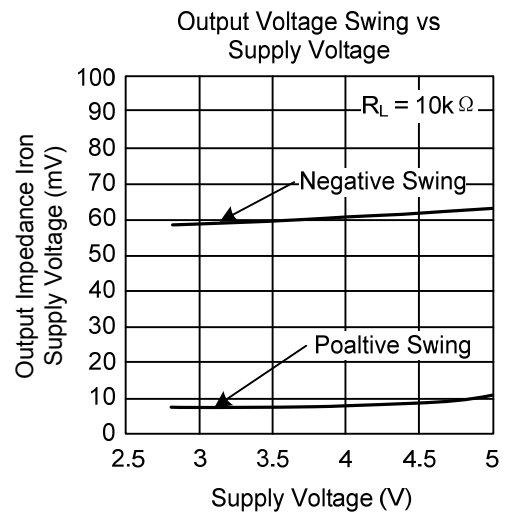
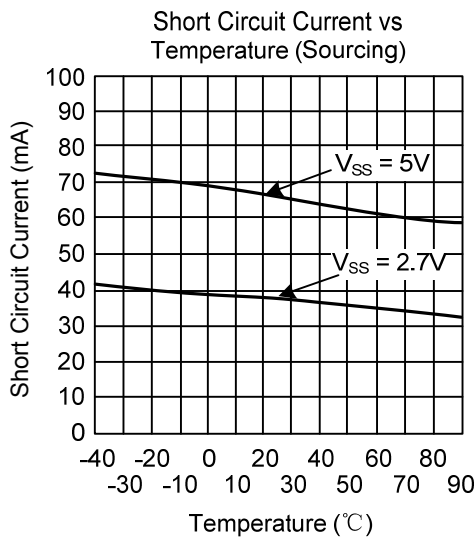
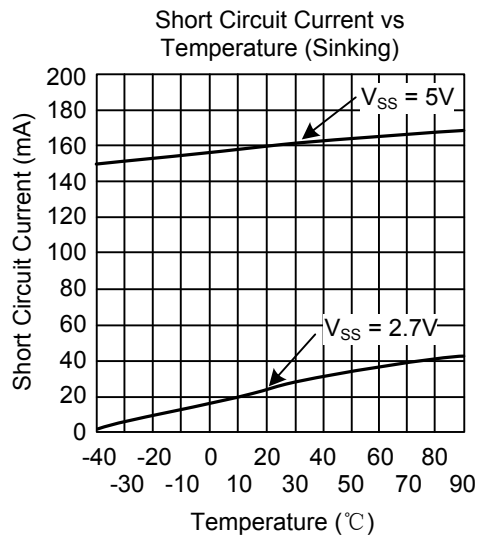
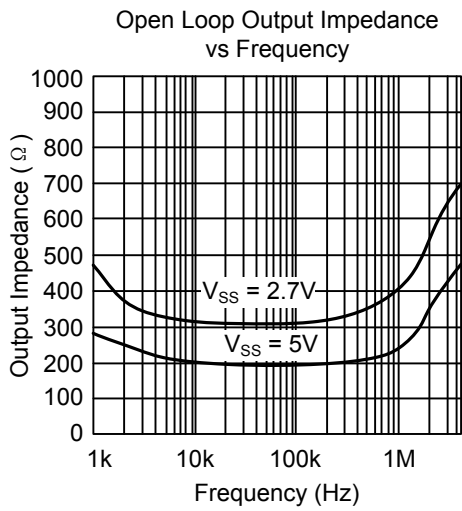

■ TYPICAL CHARACTERISTICS(Cont.)

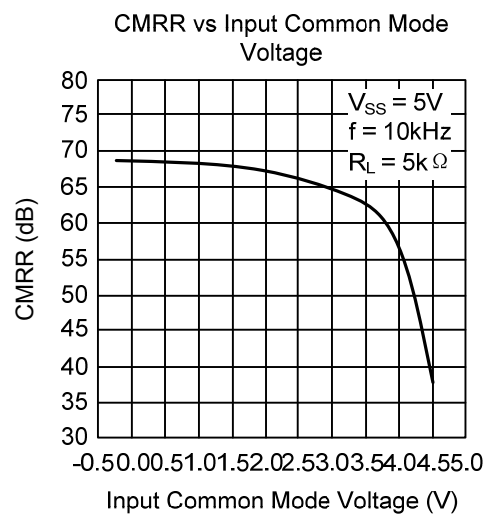
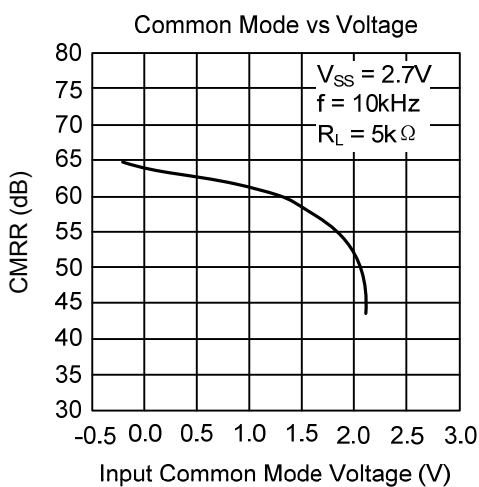
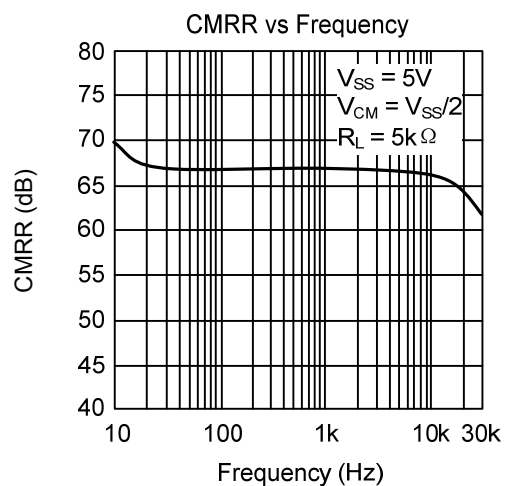
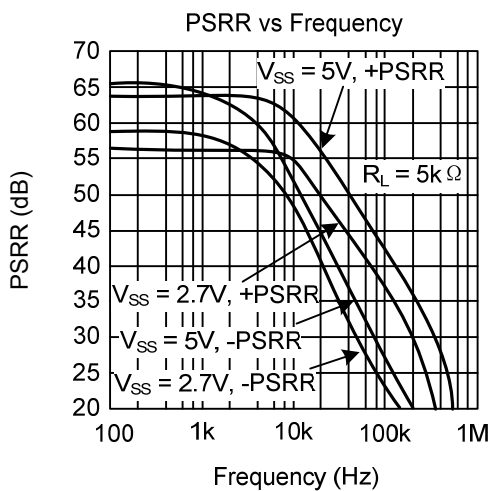
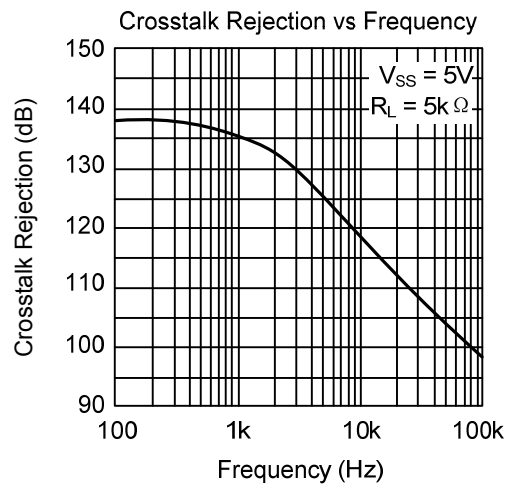
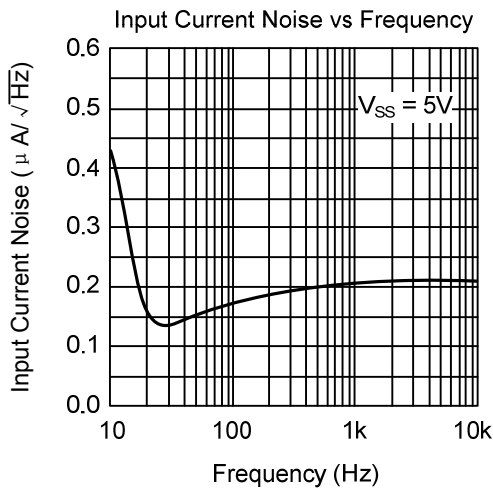

■ TYPICAL CHARACTERISTICS(Cont.)

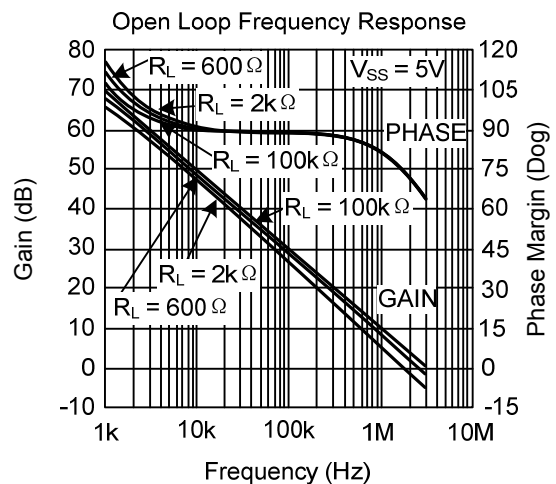
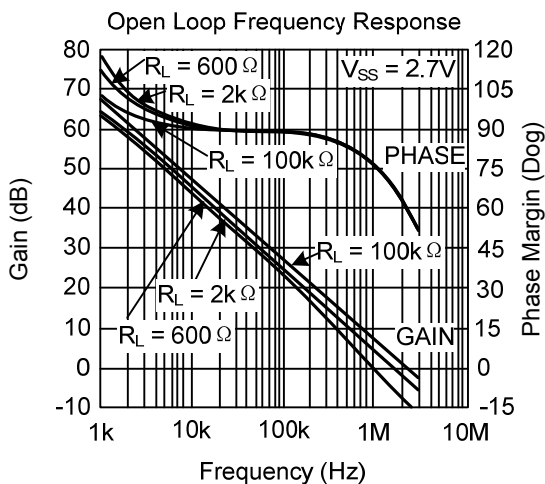
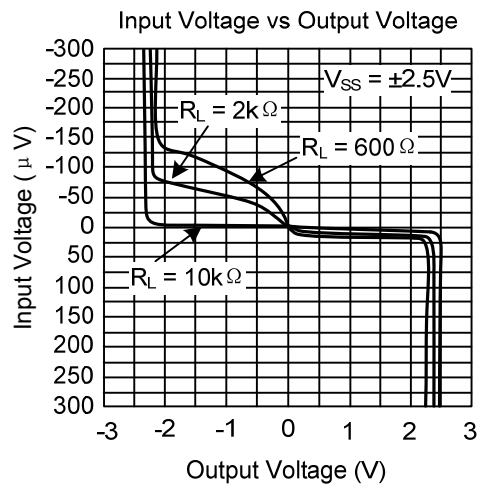
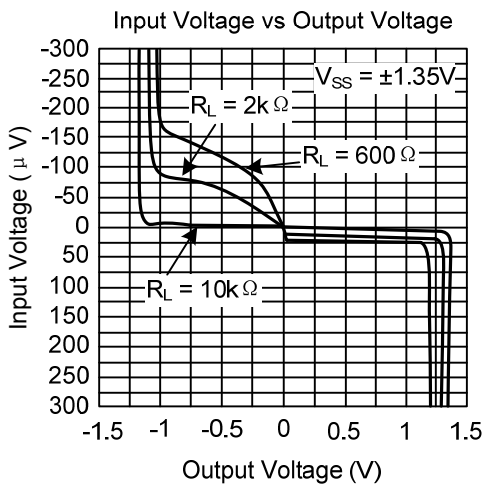
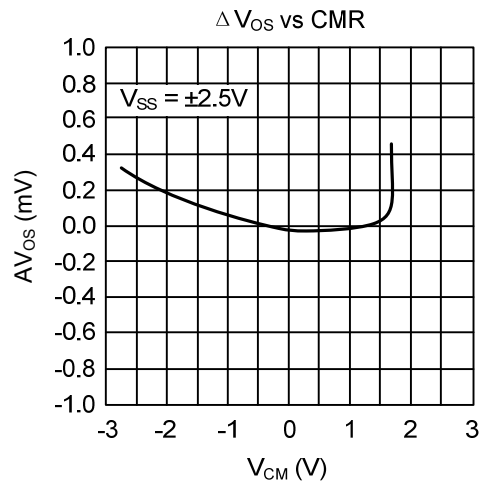
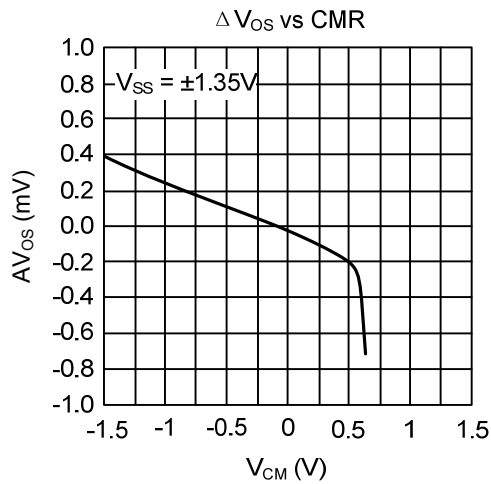

■ TYPICAL CHARACTERISTICS(Cont.)

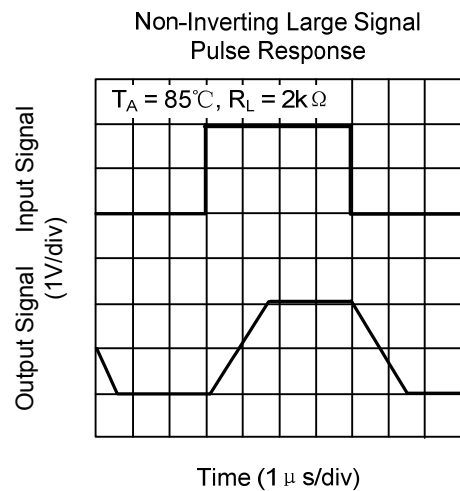
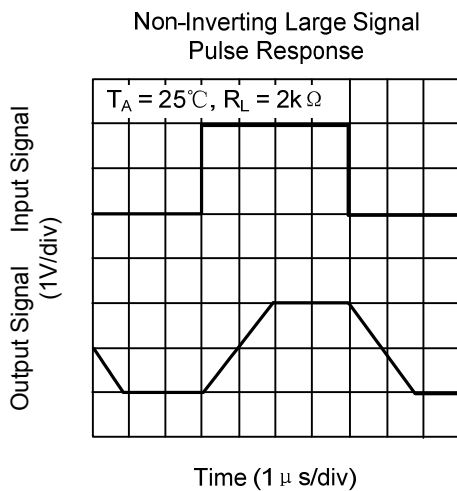
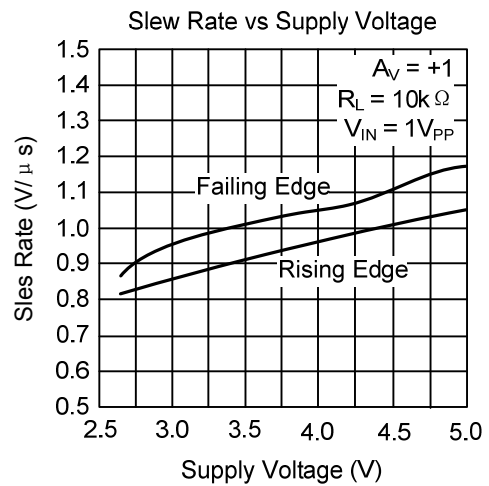
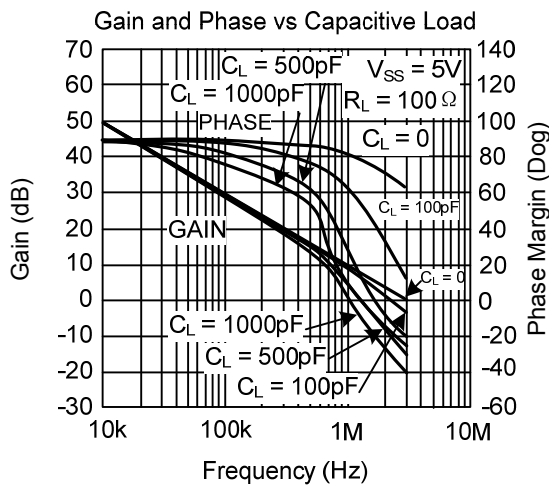
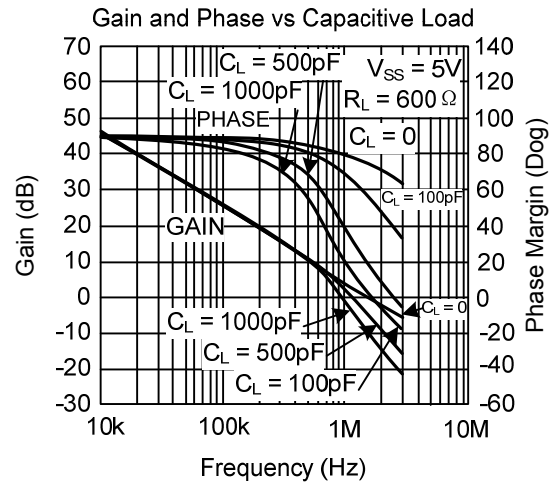
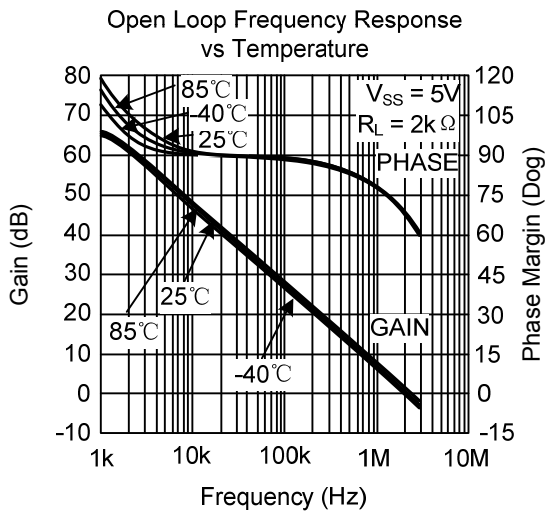

■ TYPICAL CHARACTERISTICS(Cont.)

Non-Inverting Large Signal Pulse Response

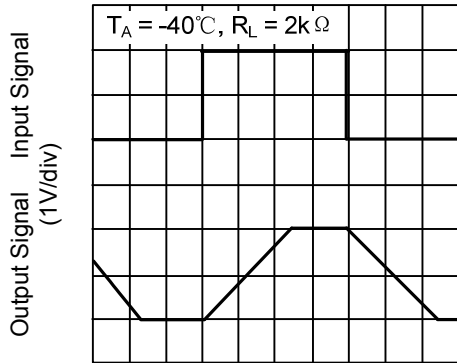

Time (1 μ s/div)

Non-Inverting Small Signal Pulse Response

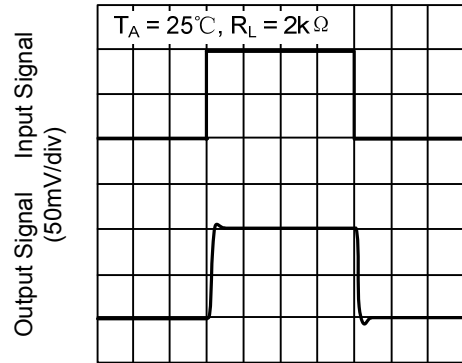

Time (1 μ s/div)

Non-Inverting Small Signal Pulse Response

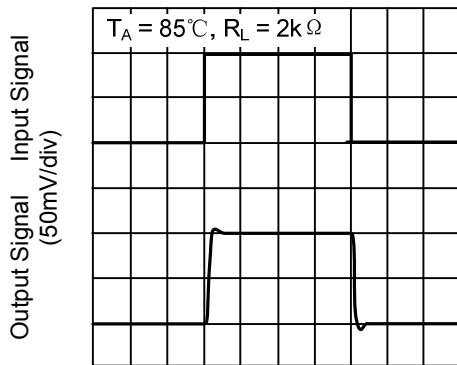

Time (1 μ s/div)

Non-Inverting Small Signal Pulse Response

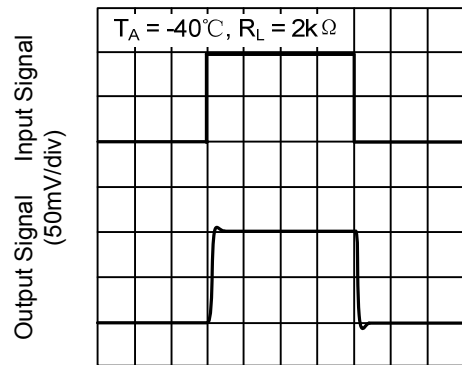

Time (1 μ s/div)

Non-Inverting Large Signal Pulse Response

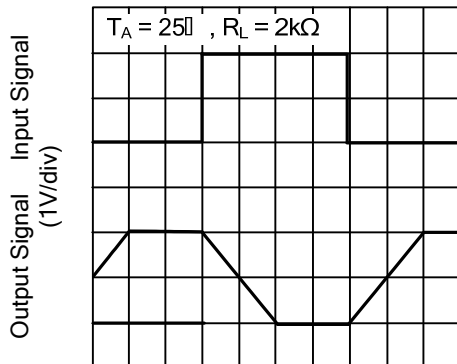

Time (1 μ s/div)

Inverting Large Signal Pulse Response

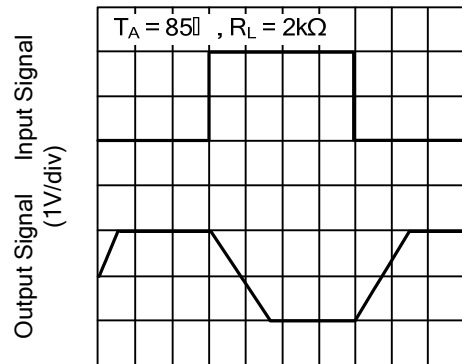

Time (1 μ s/div)

■ TYPICAL CHARACTERISTICS(Cont.)

Large Signal Pulse Response

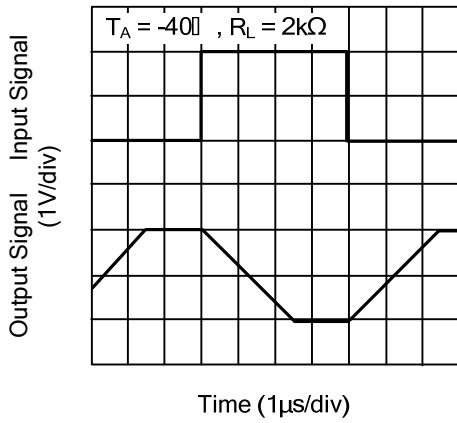

Inverting Small Signal Pulse Response

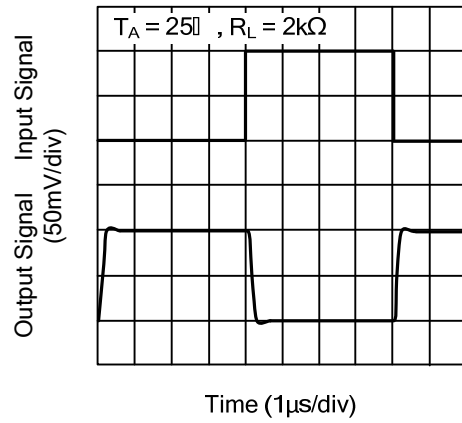

Inverting Small Signal Pulse Response

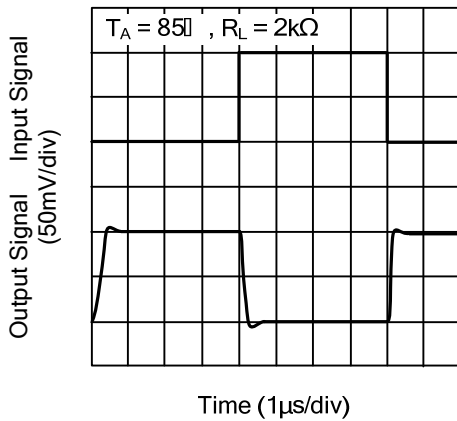

Inverting Small Signal Pulse Response

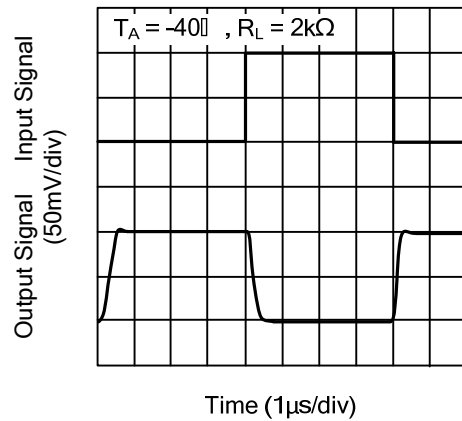

Stability vs Capacitive Load

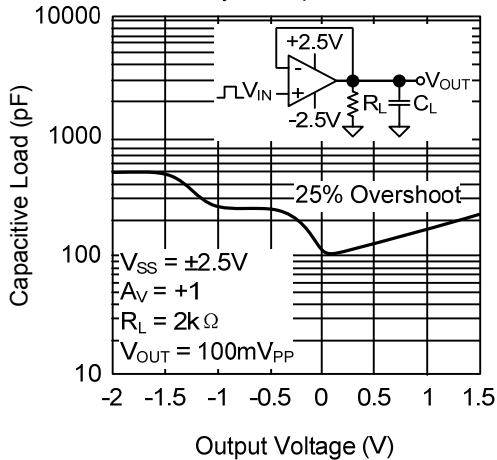

Stability vs Capacitive Load

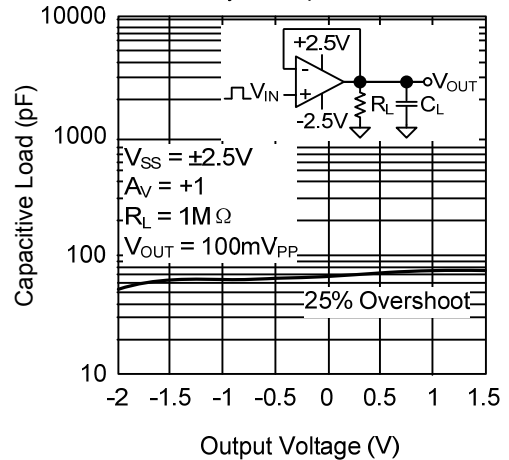

■ TYPICAL CHARACTERISTICS(Cont.)

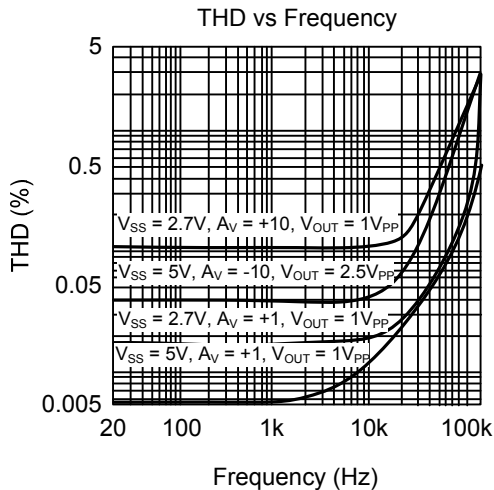
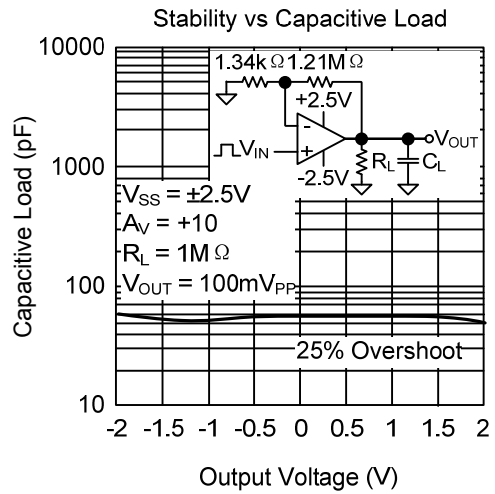
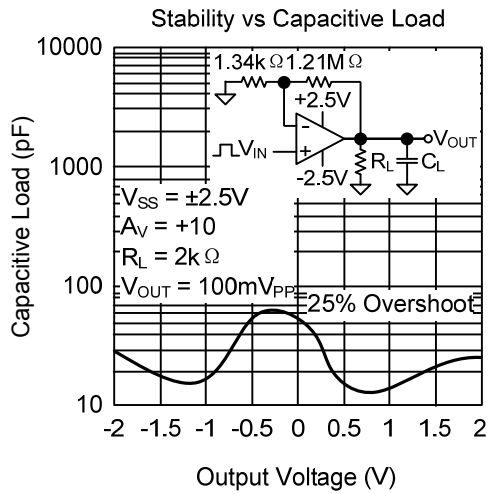

UTC assumes no responsibility for equipment failures that result from using products at values that exceed, even momentarily, rated values (such as maximum ratings, operating condition ranges, or other parameters) listed in products specifications of any and all UTC products described or contained herein. UTC products are not designed for use in life support appliances, devices or systems where malfunction of these products can be reasonably expected to result in personal injury. Reproduction in whole or in part is prohibited without the prior written consent of the copyright owner. The information presented in this document does not form part of any quotation or contract, is believed to be accurate and reliable and may be changed without notice.