

**QUAD PROGRAMMABLE OPERATIONAL AMPLIFIER  
 QUAD PROGRAMMABLE COMPARATOR  
 PROGRAMMABLE DUAL OP AMP/DUAL COMPARATOR**

The MC14573, MC14574, and MC14575 are a family of quad operational low power amplifiers and comparators using the complementary P-channel and N-channel enhancement MOS devices in a single monolithic structure. The operating current is externally programmed with a resistor to provide a choice in the tradeoff of power dissipation and slew rates. The operational amplifiers are internally compensated.

These low cost units are excellent building blocks for consumer, industrial, automotive and instrument applications. Active filters, voltage reference, function generators, oscillators, limit set alarms, TTL-to-CMOS or CMOS-to-CMOS up converters, A-to-D converters and zero crossing detectors are some applications. These units are useful in both battery and line operated systems.

- Operating Temperature Range: -40 to 85°C
- Power Supply - Single 3.0 to 15 V  
Dual ±1.5 to ±7.5 V
- Wide Input Voltage Range
- Common Mode Range 0.0 to V<sub>DD</sub> - 2.0 V for Single Supply
- Externally Programmable Power Consumption with One or Two Resistors
- Internally Compensated Operational Amplifiers
- High Input Impedance
- Comparators - JEDEC B-Series Compatible
- Chip Complexities: MC14573 - 30 FETs  
MC14574 - 46 FETs  
MC14575 - 38 FETs

**MC14573  
 MC14574  
 MC14575**

**CMOS MSI**

**QUAD PROGRAMMABLE  
 OPERATIONAL AMPLIFIER  
 QUAD PROGRAMMABLE  
 COMPARATOR  
 PROGRAMMABLE DUAL OP AMP/  
 DUAL COMPARATOR**

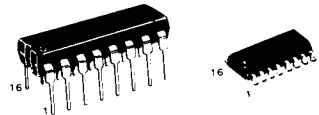

**P SUFFIX**  
 PLASTIC DIP  
 CASE 648

**D SUFFIX**  
 SOG  
 CASE 751B

**ORDERING INFORMATION**

MC1457xP  
 MC1457xD

Plastic DIP  
 SOG Package

**PIN ASSIGNMENT**

**MC14573**  
 Quad Op Amplifier

**MC14574**  
 Quad Comparator

**MC14575**  
 Dual Op Amplifier (A & B) plus  
 Dual Comparator (C & D)

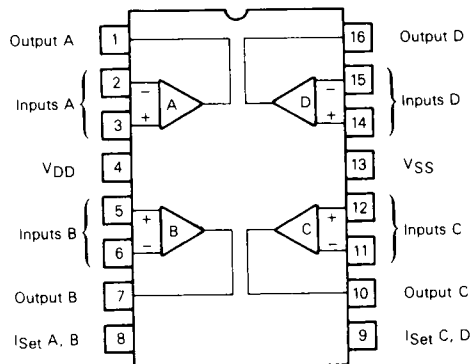

MAXIMUM RATINGS† (Voltages referenced to V<sub>SS</sub>)

Rating	Symbol	Value	Unit
DC Supply Voltage	V <sub>DD</sub>	-0.5 to +18	V
Input Voltage, All Inputs	V <sub>in</sub>	-0.5 to V <sub>DD</sub> + 0.5	V
DC Input Current, per Pin	I <sub>in</sub>	±10	mA
Programming Current Range	I <sub>Set</sub>	2	mA
Operating Temperature Range	T <sub>A</sub>	-40 to +85	°C
Storage Temperature Range	T <sub>stg</sub>	-65 to +150	°C
Package Power Dissipation*	P <sub>D</sub>	800	mW

This device contains circuitry to protect the inputs against damage due to high static voltages or electric fields, however, it is advised that normal precautions be taken to avoid application of any voltage higher than maximum rated voltages to this high impedance circuit. For proper operation it is recommended that V<sub>in</sub> and V<sub>out</sub> be constrained to the range V<sub>SS</sub> ≤ (V<sub>in</sub> or V<sub>out</sub>) ≤ V<sub>DD</sub>

\*Derate above 25°C @ 4.6 mW/°C

†Maximum Ratings are those values beyond which damage to the device may occur.

RECOMMENDED OPERATING RANGE

Rating	Symbol	Value	Unit
DC Supply Voltage	V <sub>DD</sub> to V <sub>SS</sub>	+3.0 to +15	V
Programming Current	I <sub>Set</sub>	2 to 50 2 to 750	μA

V<sub>DD</sub> = 3V  
5V < V<sub>DD</sub> < 15V

OPERATIONAL AMPLIFIER ELECTRICAL CHARACTERISTICS

(I<sub>Set</sub> = 20 μA, R<sub>L</sub> = 10 MΩ, C<sub>L</sub> = 15 pF, T<sub>A</sub> = 25°C, unless otherwise indicated, Voltages Referenced to V<sub>SS</sub>)

Characteristic	Symbol	V <sub>DD</sub> V	Min	Typ#	Max	Unit
Input Common Mode Voltage Range	V <sub>ICR</sub>	3	0	-	1.5	V
		5	0	-	3.5	
		10	0	-	8.5	
		15	0	-	13.5	
Output Voltage Range R <sub>L</sub> = 1 MΩ to V <sub>SS</sub>	V <sub>OR</sub>	3	0.05	-	2.95	V
		5	0.05	-	4.95	
		10	0.05	-	9.95	
		15	0.05	-	14.90	
Input Offset Voltage MC14573, MC14575	V <sub>IO</sub>	3	-	±5	±30	mV
		5	-	±8	±30	
		10	-	±10	±30	
		15	-	±10	±30	
Average Temperature Coefficient of V <sub>IO</sub>	ΔV <sub>IO</sub> /ΔT	-	-	15	-	μV/°C
Input Capacitance	C <sub>in</sub>	-	-	5	10	pF
Input Bias Current	I <sub>IB</sub>	-	-	1	50	pA
Input Bias Current	I <sub>IB</sub>	-	-	-	1	nA
Input Offset Current	I <sub>IO</sub>	-	-	-	100	pA
Open Loop Voltage Gain V <sub>O</sub> = 1 V p-p V <sub>O</sub> = 3 V p-p V <sub>O</sub> = 6 V p-p V <sub>O</sub> = 9 V p-p	A <sub>VOL</sub>	3	2	8	-	V/mV
		5	5	10	-	
		10	8	12	-	
		15	8	12	-	
Power Supply Rejection Ratio MC14573, MC14575	PSRR	3	45	57	-	dB
		5	54	67	-	
		10	54	67	-	
		15	54	67	-	
Common Mode Rejection Ratio MC14573, MC14575	CMRR	3	45	70	-	dB
		5	50	73	-	
		10	54	75	-	
		15	54	75	-	
Output Source Current V <sub>OH</sub> = V <sub>DD</sub> - 0.6 V	I <sub>OH</sub>	5	55	80	-	μA
Output Sink Current V <sub>in+</sub> = V <sub>DD</sub> /2 + 0.5 V <sub>in-</sub> = V <sub>DD</sub> /2 - 0.5 V <sub>OL</sub> = 0.4 V V <sub>OL</sub> = 0.4 V V <sub>OL</sub> = 0.5 V V <sub>OL</sub> = 1.5 V	I <sub>OL</sub>	3	2.1	4.2	-	mA
		5	2.5	5.0	-	
		10	5.5	11.0	-	
		15	15	30	-	
Slew Rate	S <sub>R</sub>	-	0.6	0.8	-	V/μs
Unity Gain Bandwidth	GBW	5	0.5	1	-	MHz
Phase Margin	φ <sub>M</sub>	-	-	45	-	Degrees
Channel Separation	-	-	-	80	-	dB
Supply Current, Per Pair R <sub>L</sub> = ∞, I <sub>Set</sub> = 20 μA, V <sub>in+</sub> = 1.0 V, V <sub>in-</sub> = 0 V (R <sub>L</sub> = ∞, Pins 8 and 9 = V <sub>DD</sub> )	I <sub>DD</sub>	5	-	260	340	μA
		15	-	0.05	1.0	

#Data labelled "Typ" is not to be used for design purposes but is intended as an indication of the IC's potential performance.



# MC14573•MC14574•MC14575

## OPERATIONAL AMPLIFIER ELECTRICAL CHARACTERISTICS

( $I_{Set} = 200 \mu A$ ,  $R_L = 10 M\Omega$ ,  $C_L = 15 pF$ ,  $T_A = 25^\circ C$ , unless otherwise indicated, Voltages Referenced to  $V_{SS}$ )

Characteristic	Symbol	$V_{DD}$ V	Min	Typ#	Max	Unit
Input Common Mode Voltage Range	$V_{ICR}$	5 10 15	0 0 0	— — —	3 8 13	V
Output Voltage Range $R_L = 100 k$ to $V_{SS}$	$V_{OR}$	5 10 15	0.1 0.1 0.1	— — —	4.8 9.8 14.8	V
Input Offset Voltage MC14573, MC14575	$V_{IO}$	5 10 15	— — —	$\pm 8$ $\pm 10$ $\pm 12$	$\pm 30$ $\pm 30$ $\pm 30$	mV
Average Temperature Coefficient of $V_{IO}$	$\Delta V_{IO}/\Delta T$	—	—	20	—	$\mu V/^\circ C$
Input Capacitance	$C_{in}$	—	—	5	10	pF
Input Bias Current	$I_{IB}$	—	—	1	50	pA
Input Bias Current $T_A = -40^\circ C$ to $+85^\circ C$	$I_{IB}$	—	—	—	1	nA
Input Offset Current	$I_{IO}$	—	—	—	100	pA
Open Loop Voltage Gain $V_O = 3 V$ p-p $V_O = 6 V$ p-p $V_O = 9 V$ p-p	$AV_{OL}$	5 10 15	1 1 1	2 3 4	— — —	V/mV
Power Supply Rejection Ratio MC14573, MC14575	PSRR	5 10 15	45 54 54	54 67 67	— — —	dB
Common Mode Rejection Ratio MC14573, MC14575	CMRR	5 10 15	40 50 50	55 67 70	— — —	dB
Output Source Current $V_{OH} = V_{DD} - 1.5 V$	$I_{OH}$	15	550	800	—	$\mu A$
Output Sink Current $V_{OL} = 0.4 V$ $V_{OL} = 0.5 V$ $V_{OL} = 1.5 V$	$I_{OL}$	5 10 15	2.2 5.0 15	4.2 10.0 30	— — —	mA
Slew Rate	$S_R$	—	5	7	—	V/ $\mu s$
Unity Gain Bandwidth	$GBW$	5	1.5	3	—	MHz
Phase Margin	$\phi_M$	—	—	48	—	Degrees
Channel Separation	—	—	—	80	—	dB
Supply Current, Per Pair ( $R_L = \infty$ , $V_{in+} = 1.0 V$ , $V_{in-} = 0 V$ )	$I_{DD}$	15	—	2.6	3.4	mA

#Data labelled "Typ" is not to be used for design purposes but is intended as an indication of the IC's potential performance.

COMPARATOR ELECTRICAL CHARACTERISTICS

(I<sub>Set</sub> = 20 μA, R<sub>L</sub> = 10 MΩ, C<sub>L</sub> = 50 pF, T<sub>A</sub> = 25°C, unless otherwise indicated, Voltages Referenced to V<sub>SS</sub>)

Characteristic	Symbol	V <sub>DD</sub> V	Min	Typ #	Max	Unit
Input Common Mode Voltage Range	V <sub>ICR</sub>	3	0	—	1.5	V
		5	0	—	3.5	
		10	0	—	8.5	
		15	0	—	13.5	
Output Voltage Range "0" Level	V <sub>OL</sub>	3	—	0	0.05	V
		5	—	0	0.05	
		10	—	0	0.05	
		15	—	0	0.05	
Output Voltage Range "1" Level	V <sub>OH</sub>	3	2.95	3	—	V
		5	4.95	5	—	
		10	9.95	10	—	
		15	14.95	15	—	
Input Offset Voltage MC14574, MC14575	V <sub>IO</sub>	3	—	±8	±30	mV
		5	—	±8	±30	
		10	—	±10	±30	
		15	—	±10	±30	
Average Temperature Coefficient of V <sub>IO</sub>	ΔV <sub>IO</sub> /ΔT	—	—	15	—	μV/°C
Input Capacitance	C <sub>in</sub>	—	—	5	10	pF
Input Bias Current	I <sub>IB</sub>	—	—	1	50	pA
Input Bias Current T <sub>A</sub> = -40°C to +85°C	I <sub>IB</sub>	—	—	—	1	nA
Input Offset Current	I <sub>IO</sub>	—	—	—	100	pA
Open Loop Voltage Gain V <sub>O</sub> = 1 Vp-p V <sub>O</sub> = 3 Vp-p V <sub>O</sub> = 6 Vp-p V <sub>O</sub> = 9 Vp-p	A <sub>VOL</sub>	3	1	20	—	V/mV
		5	1	10	—	
		10	1	6	—	
		15	1	6	—	
Power Supply Rejection Ratio MC14574, MC14575	PSRR	3	45	57	—	dB
		5	54	67	—	
		10	54	67	—	
		15	54	67	—	
Common Mode Rejection Ratio MC14574, MC14575	CMRR	3	45	55	—	dB
		5	50	65	—	
		10	54	67	—	
		15	54	67	—	
Output Source Current V <sub>OH</sub> = 2.6 V V <sub>OH</sub> = 2.5 V V <sub>OH</sub> = 4.6 V V <sub>OH</sub> = 9.5 V V <sub>OH</sub> = 13.5 V	I <sub>OH</sub>	3	-0.35	-0.65	—	mA
		5	-2.5	-5.0	—	
		5	-0.60	-1.1	—	
		10	-1.3	-2.5	—	
		15	-5.0	-9.5	—	
Output Sink Current V <sub>OL</sub> = 0.4 V V <sub>OL</sub> = 0.4 V V <sub>OL</sub> = 0.5 V V <sub>OL</sub> = 1.5 V	I <sub>OL</sub>	3	1.3	2.6	—	mA
		5	1.9	3.8	—	
		10	3.5	6.5	—	
		15	14	25	—	
Output Rise and Fall Time, 100 mV Overdrive	t <sub>TLH</sub> , t <sub>THL</sub>	3	—	140	250	ns
		5	—	100	180	
		10	—	120	200	
		15	—	140	250	
Propagation Delay Time, 5 mV Overdrive	t <sub>d</sub>	3	—	15	30	μs
		5	—	10	20	
		10	—	12	24	
		15	—	15	30	
Propagation Delay Time, 100 mV Overdrive	t <sub>d</sub>	3	—	4	8	μs
		5	—	2	4	
		10	—	3	6	
		15	—	4	8	
Channel Separation	—	—	—	80	—	dB
Supply Current, Per Pair (R <sub>L</sub> = ∞, I <sub>Set</sub> = 20 μA, V <sub>In+</sub> = 1.0 V, V <sub>In-</sub> = 0 V)	I <sub>DD</sub>	5	—	180	250	μA

#Data labelled "Typ" is not to be used for design purposes but is intended as an indication of the IC's potential performance.

COMPARATOR ELECTRICAL CHARACTERISTICS

(I<sub>Set</sub> = 200 μA, R<sub>L</sub> = 10 MΩ, C<sub>L</sub> = 50 pF, T<sub>A</sub> = 25°C, unless otherwise indicated, Voltages Referenced to V<sub>SS</sub>)

Characteristic	Symbol	V <sub>DD</sub> V	Min	Typ#	Max	Unit
Input Common Mode Voltage Range	V <sub>ICR</sub>	5 10 15	0 0 0	— — —	3 8 13	V
Output Voltage Range "0" Level	V <sub>OL</sub>	5 10 15	— — —	0 0 0	0.05 0.05 0.05	V
Output Voltage Range "1" Level	V <sub>OH</sub>	5 10 15	4.95 9.95 14.95	5 10 15	— — —	V
Input Offset Voltage MC14574, MC14575	V <sub>IO</sub>	5 10 15	— — —	± 10 ± 13 ± 15	± 30 ± 30 ± 30	mV
Average Temperature Coefficient of V <sub>IO</sub>	T <sub>A</sub> = -40°C to +85°C	ΔV <sub>IO</sub> /ΔT	—	—	20	μV/°C
Input Capacitance	C <sub>in</sub>	—	—	5	10	pF
Input Bias Current	I <sub>IB</sub>	—	—	1	50	pA
Input Bias Current	T <sub>A</sub> = -40°C to +85°C	I <sub>IB</sub>	—	—	1	nA
Input Offset Current	I <sub>IO</sub>	—	—	—	100	pA
Open Loop Voltage Gain	V <sub>O</sub> = 3 Vp-p V <sub>O</sub> = 6 Vp-p V <sub>O</sub> = 9 Vp-p	A <sub>VOL</sub>	5 10 15	2 1 1	7 4 4	V/mV
Power Supply Rejection Ratio MC14574, MC14575	PSRR	5 10 15	45 54 54	67 67 67	— — —	dB
Common Mode Rejection Ratio MC14574, MC14575	CMRR	5 10 15	40 50 50	65 67 67	— — —	dB
Output Source Current	V <sub>OH</sub> = 2.5 V V <sub>OH</sub> = 4.6 V V <sub>OH</sub> = 9.5 V V <sub>OH</sub> = 13.5 V	I <sub>OH</sub>	5 5 10 15	-2.5 -0.60 -1.3 -5.0	-5.0 -1.1 -2.5 -9.5	mA
Output Sink Current	V <sub>OL</sub> = 0.4 V V <sub>OL</sub> = 0.5 V V <sub>OL</sub> = 1.5 V	I <sub>OL</sub>	5 10 15	1.9 3.5 14	3.8 6.5 25	mA
Output Rise and Fall Time, 100 mV Overdrive	t <sub>TLH</sub> t <sub>THL</sub>	5 10 15	— — —	75 50 45	150 100 90	ns
Propagation Delay Time, 5 mV Overdrive	t <sub>d</sub>	5 10 15	— — —	2.5 3.5 5	5.0 7 10	μs
Propagation Delay Time, 100 mV Overdrive	t <sub>d</sub>	5 10 15	— — —	0.6 0.75 0.75	1.2 1.5 1.5	μs
Channel Separation	—	—	—	80	—	dB
Supply Current, Per Pair (R <sub>L</sub> = ∞, V <sub>in+</sub> = 1.0 V, V <sub>in-</sub> = 0 V)	I <sub>DD</sub>	15	—	1.8	2.5	mA

#Data labelled "Typ" is not to be used for design purposes but is intended as an indication of the IC's potential performance.

4

The programming current  $I_{Set}$  is fixed by an external resistor  $R_{Set}$  connected between  $V_{SS}$  and either one or both of the  $I_{Set}$  pins (8 and 9). When two external programming resistors are used, the set currents for each op amp pair or comparator are given by:

$$I_{Set} (\mu A) \approx \frac{V_{DD} - V_{SS} - 1.5}{R_{Set} (M\Omega)}$$

Pins 8 and 9 may be tied together for use with a single programming resistor. The set currents for each op amp pair or comparator pair are then given by:

$$I_{Set A, B} = I_{Set C, D} (\mu A) \approx \frac{V_{DD} - V_{SS} - 1.5}{2 R_{Set} (M\Omega)}$$

The total device current is typically 13 times  $I_{Set}$  per pair if the outputs are in the low state, and 5 times  $I_{Set}$  per pair if the outputs are in the high state. For op amps with an output in the linear region the device current will be between the values of 5 times and 13 times  $I_{Set}$ .

If a pair of op amps is not used, the  $I_{Set}$  pin for that pair may be tied to  $V_{DD}$  for minimum power consumption. To minimize power consumption in an unused pair of comparators this is not effective. The comparators should use a high value set resistor and the inputs should be set to a voltage that will force the output to  $V_{DD}$  (i.e.,  $+in = V_{DD}$ ,  $-in = V_{SS}$ ).

It should be noted that increasing  $I_{Set}$  for comparators will decrease propagation delay for that comparator.

For operational amplifiers, the maximum obtainable output voltage ( $V_{OH}$ ) for a given load resistor connected to  $V_{SS}$  is given by:

$$V_{OH} = 4 \times I_{Set} \times R_L - 0.05 V, R_L \text{ in } \Omega, I_{Set} \text{ in } A$$

Note:  $V_{OH} \text{ Max} = V_{DD}$

Typical op amp slew rates are given by:

$$S_R \approx 0.04 I_{Set} (V/\mu s), I_{Set} \text{ in } \mu A$$

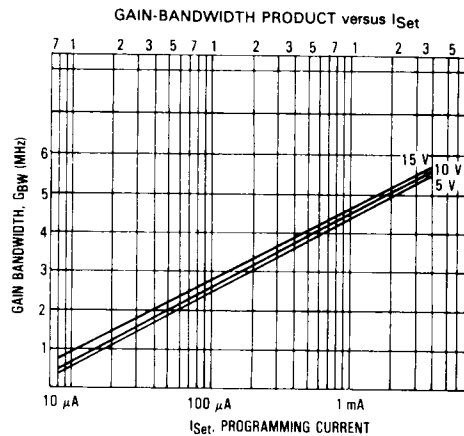
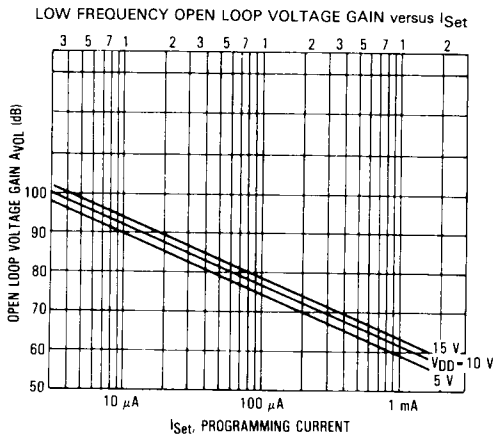
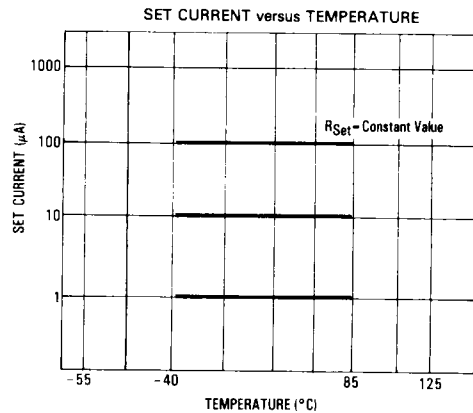
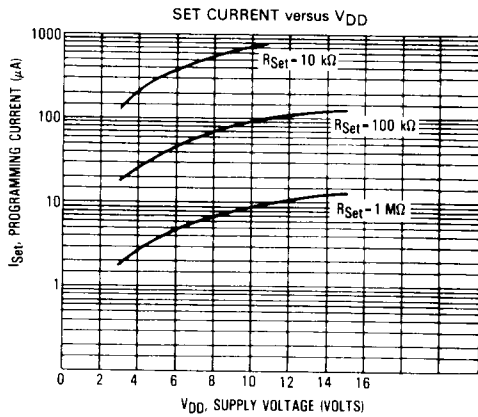

4

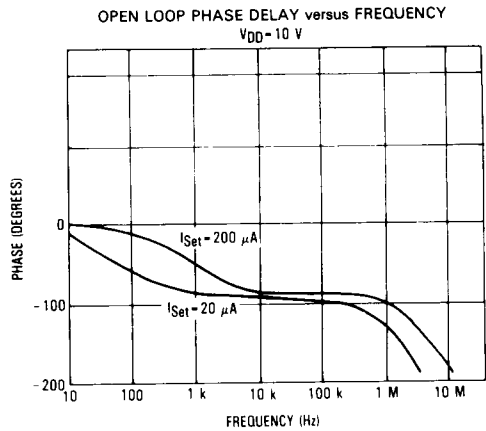
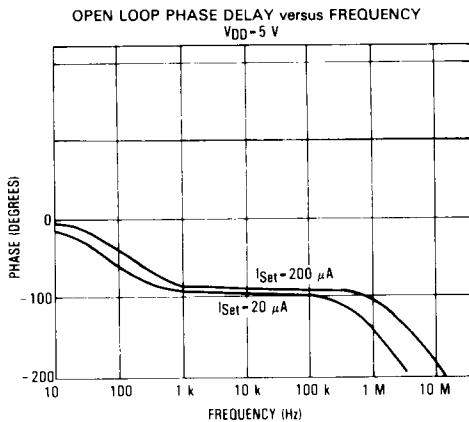
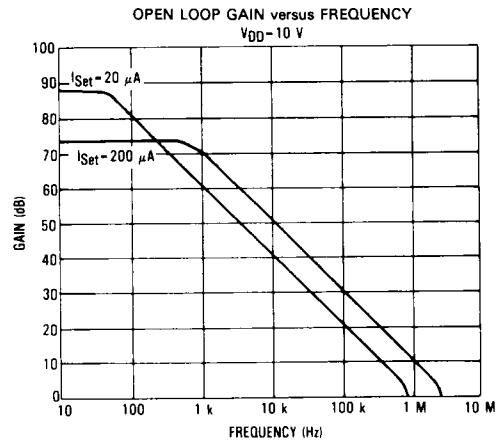
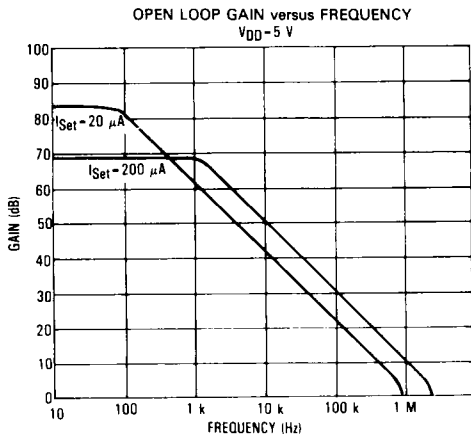
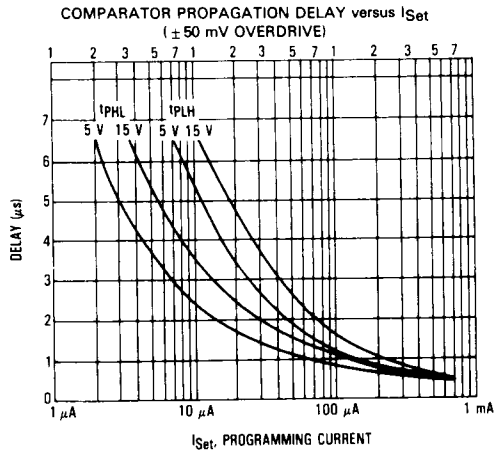
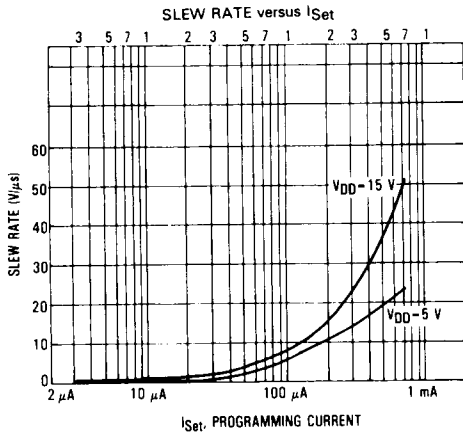

SMALL SIGNAL TRANSIENT RESPONSE  
 $V_{DD} = 10\text{ V}$  NON-INVERTING UNITY GAIN  
 $I_{Set} = 200\ \mu\text{A}$ ,  $V_{in}$  AVERAGE = 5 V

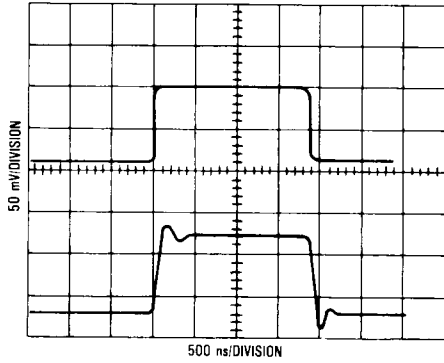

LARGE SIGNAL TRANSIENT RESPONSE  
 $V_{DD} = 10\text{ V}$  NON-INVERTING UNITY GAIN  
 $I_{Set} = 200\ \mu\text{A}$ ,  $V_{in}$  AVERAGE = 5 V

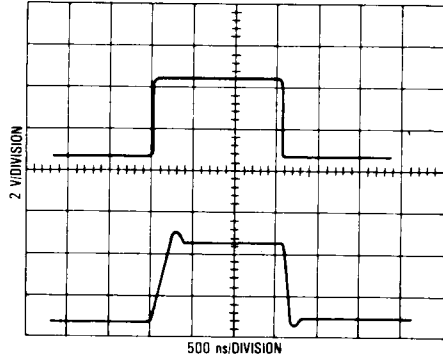

SMALL SIGNAL TRANSIENT RESPONSE  
 $V_{DD} = 10\text{ V}$  NON-INVERTING UNITY GAIN  
 $I_{Set} = 20\ \mu\text{A}$ ,  $V_{in}$  AVERAGE = 5 V

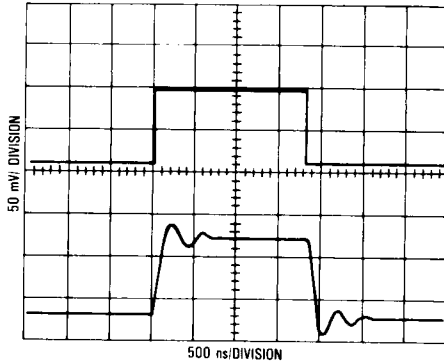

LARGE SIGNAL TRANSIENT RESPONSE  
 $V_{DD} = 10\text{ V}$  NON-INVERTING UNITY GAIN  
 $I_{Set} = 20\ \mu\text{A}$ ,  $V_{in}$  AVERAGE = 5 V

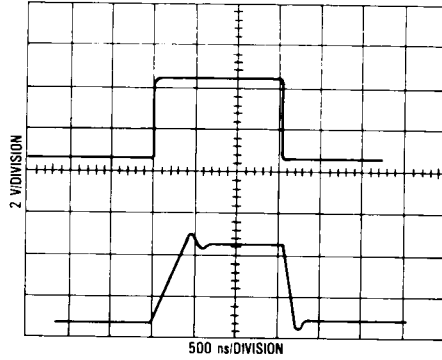

EQUIVALENT INPUT NOISE VOLTAGE ( $E_N$ ) versus FREQUENCY

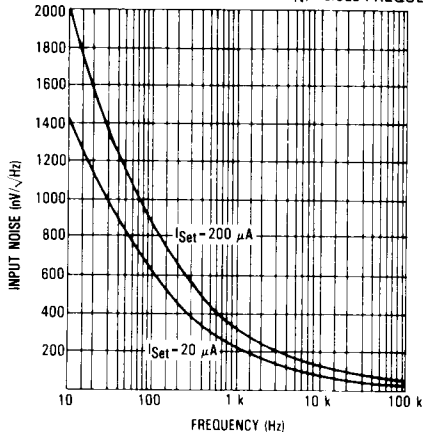

TYPICAL INPUT LEAKAGE versus TEMPERATURE  
 $V_{DD} = 15\text{ V}$ ,  $V_{in} = 7.5\text{ V}$

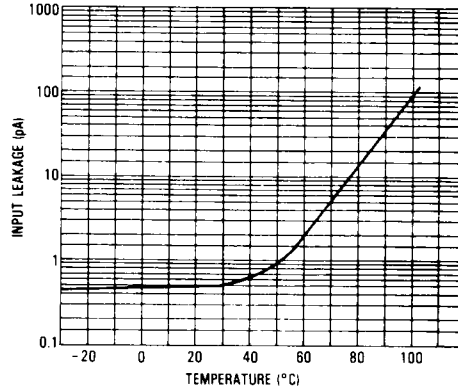



COMPARATOR PROPAGATION DELAY versus OVERDRIVE\*  
 $V_{DD} = 10\text{ V}$ ,  $t_{PLH}$  and  $t_{PHL}$

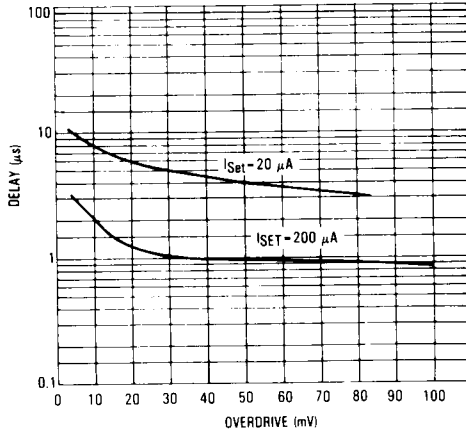

\* A 10 mV overdrive is a signal on one input of a comparator that ranges from 10 mV less than the other input to 10 mV more than the other input.

4

OPERATIONAL AMPLIFIER SCHEMATIC  
 1/4th CIRCUIT

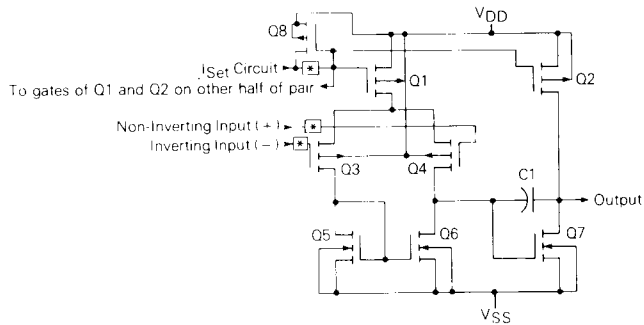

COMPARATOR SCHEMATIC  
 1/4th CIRCUIT

