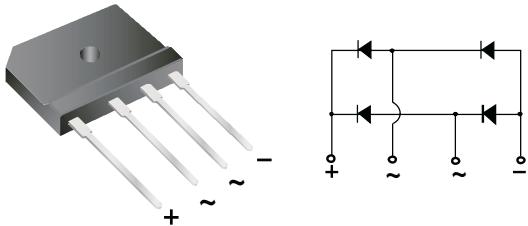

## 20 Amp. Glass Passivated Single Phase In Line Bridge Rectifier

<p><b>IN LINE BIG</b></p> 	<table style="width: 100%; border-collapse: collapse;"> <tr> <td style="text-align: center;"><b>Voltage</b> 400 V to 1000 V</td> <td style="text-align: center;"><b>Current</b> 20 A</td> </tr> <tr> <td colspan="2"> <b>FEATURES</b> <ul style="list-style-type: none"> <li>UL recognition file number E320541, Vol. 2</li> <li>Ideal for printed circuit board</li> <li>High case dielectric strength of 2000 Vrms</li> <li>High surge current capability</li> <li>Solder dip 260°C, 10s</li> <li>Component in accordance to RoHS 2011/65/EU and WEEE 2002/96/EC</li> </ul> </td> </tr> <tr> <td colspan="2"> <b>MECHANICAL DATA</b> <ul style="list-style-type: none"> <li><b>Case:</b> IN LINE BIG. Epoxy meets UL 94V-0 flammability rating.</li> <li><b>Polarity:</b> As marked on body</li> <li><b>Mounting Torque:</b> 5.5cm·kg (5 in.- lbs.)</li> <li><b>Terminals:</b> Matte tin plated leads, solderable per MIL-STD-750 Method 2026, J-STD-002 and JESD22-B102. Consumer grade, meets JESD 201 class 1A whisker test</li> </ul> </td> </tr> <tr> <td colspan="2"> <b>TYPICAL APPLICATIONS</b>                      Used in ac-to-dc bridge full wave rectification for monitor, TV, printer, switching mode power supply, adapter, audio equipment, and home appliances applications.                 </td> </tr> </table>	<b>Voltage</b> 400 V to 1000 V	<b>Current</b> 20 A	<b>FEATURES</b> <ul style="list-style-type: none"> <li>UL recognition file number E320541, Vol. 2</li> <li>Ideal for printed circuit board</li> <li>High case dielectric strength of 2000 Vrms</li> <li>High surge current capability</li> <li>Solder dip 260°C, 10s</li> <li>Component in accordance to RoHS 2011/65/EU and WEEE 2002/96/EC</li> </ul>		<b>MECHANICAL DATA</b> <ul style="list-style-type: none"> <li><b>Case:</b> IN LINE BIG. Epoxy meets UL 94V-0 flammability rating.</li> <li><b>Polarity:</b> As marked on body</li> <li><b>Mounting Torque:</b> 5.5cm·kg (5 in.- lbs.)</li> <li><b>Terminals:</b> Matte tin plated leads, solderable per MIL-STD-750 Method 2026, J-STD-002 and JESD22-B102. Consumer grade, meets JESD 201 class 1A whisker test</li> </ul>		<b>TYPICAL APPLICATIONS</b> Used in ac-to-dc bridge full wave rectification for monitor, TV, printer, switching mode power supply, adapter, audio equipment, and home appliances applications.	
<b>Voltage</b> 400 V to 1000 V	<b>Current</b> 20 A								
<b>FEATURES</b> <ul style="list-style-type: none"> <li>UL recognition file number E320541, Vol. 2</li> <li>Ideal for printed circuit board</li> <li>High case dielectric strength of 2000 Vrms</li> <li>High surge current capability</li> <li>Solder dip 260°C, 10s</li> <li>Component in accordance to RoHS 2011/65/EU and WEEE 2002/96/EC</li> </ul>									
<b>MECHANICAL DATA</b> <ul style="list-style-type: none"> <li><b>Case:</b> IN LINE BIG. Epoxy meets UL 94V-0 flammability rating.</li> <li><b>Polarity:</b> As marked on body</li> <li><b>Mounting Torque:</b> 5.5cm·kg (5 in.- lbs.)</li> <li><b>Terminals:</b> Matte tin plated leads, solderable per MIL-STD-750 Method 2026, J-STD-002 and JESD22-B102. Consumer grade, meets JESD 201 class 1A whisker test</li> </ul>									
<b>TYPICAL APPLICATIONS</b> Used in ac-to-dc bridge full wave rectification for monitor, TV, printer, switching mode power supply, adapter, audio equipment, and home appliances applications.									

### Maximum Ratings and Electrical Characteristics at 25 °C

Marking Code		D20XB40	D20XB60	D20XB80	D20XB100
$V_{RRM}$	Peak recurrent reverse voltage (V)	400	600	800	1000
$V_{RMS}$	Maximum RMS Voltage (V)	280	420	560	700
$I_{F(AV)}$	Max. Average forward current	20 A at $T_c: 87^\circ C$ (Note 1) 3.2 A at $25^\circ C$ (Note 2)			
$I_{FSM}$	Peak forward surge current 10ms single half sine-wave superimposed on rated load (Jedec Method)	240 A			
$V_{DIS}$	Dielectric strength (terminals to case, AC 1 min.)	2000 V			
$i^2t$	Current squared time (rating for fusing) (1ms.<t<10ms. $T_c = 25^\circ C$ )	240 A <sup>2</sup> sec			
$T_j$	Operating temperature range	-55 to +150 °C			
$T_{stg}$	Storage temperature range	-55 to +150 °C			

### Electrical Characteristics at Tamb = 25 °C

$V_F$	Max. Instantaneous forward voltage @ = 10 A	1.0 V
$I_R$	Maximum DC Reverse Current @ $T_A = 25^\circ C$ at Rated DC Blocking Voltage @ $T_A = 125^\circ C$	10 $\mu A$ 500 $\mu A$
$R_{th(j-c)}$ $R_{th(j-a)}$	Typical Thermal Resistance Junction-case Junction-Ambient	1.5 °C/W (Note 1) 22 °C/W (Note 2)

Notes: 1. Unit case mounted on aluminum plate heatsink  
2. Units mounted on P.C.B. without heatsink

**20 Amp. Glass Passivated Single Phase In Line Bridge Rectifier**

**Ordering information**

PREFERRED P/N	PACKAGE CODE	DELIVERY MODE	BASE QUANTITY	UNIT WEIGHT (g)
D20XB60 TU	TU	TUBE	15	6.50

**Package Outline Dimensions: (mm) IN LINE BIG**

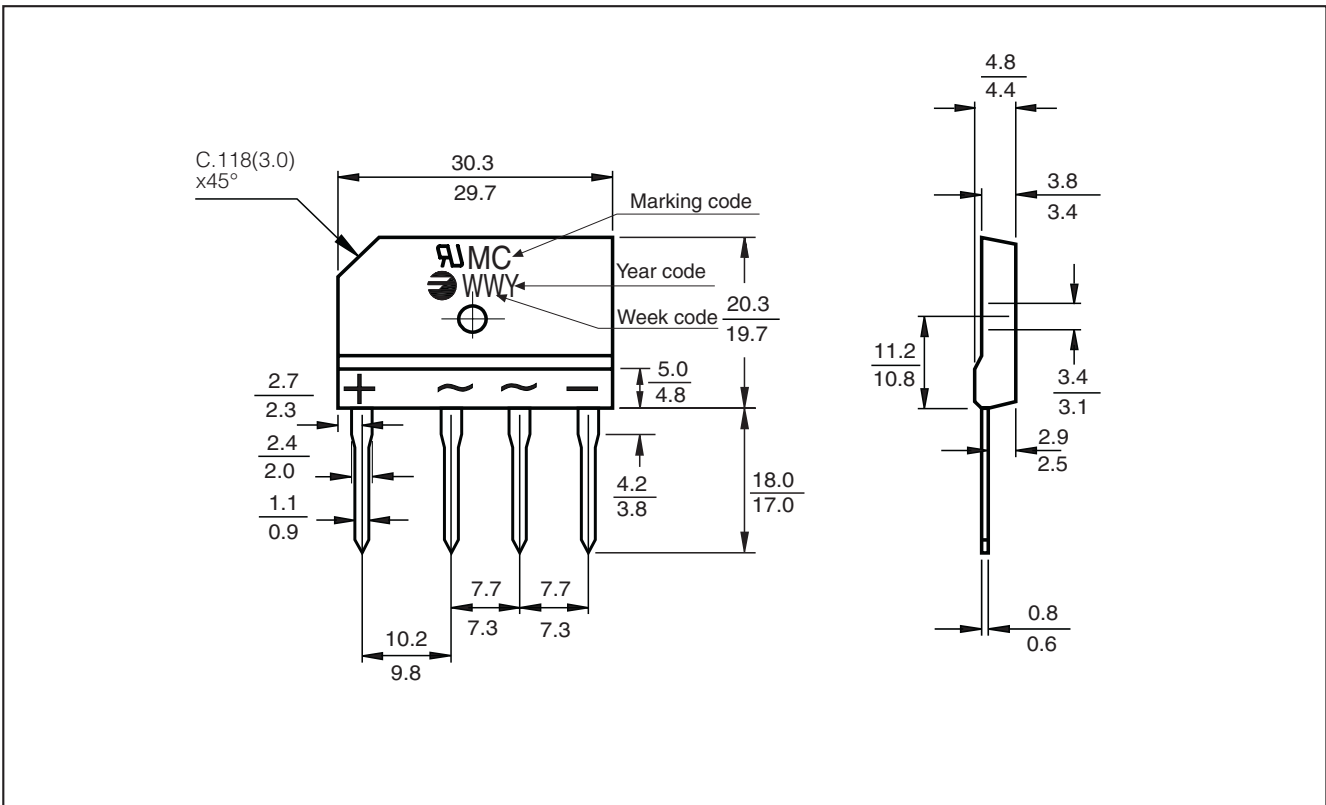

**20 Amp. Glass Passivated Single Phase In Line Bridge Rectifier**

**Ratings and Characteristics (Ta 25 °C unless otherwise noted)**

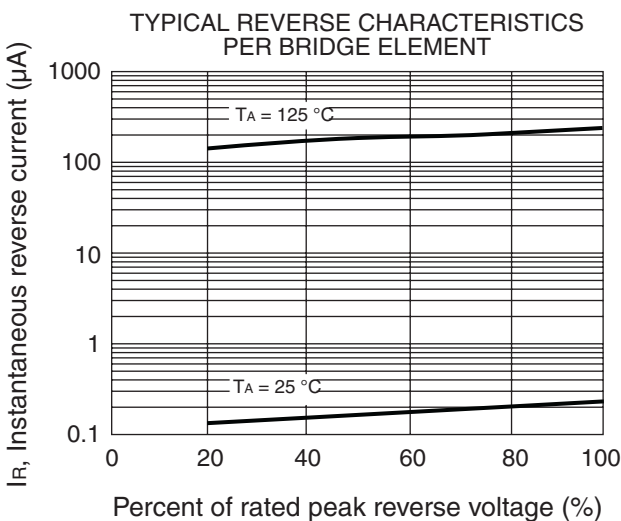
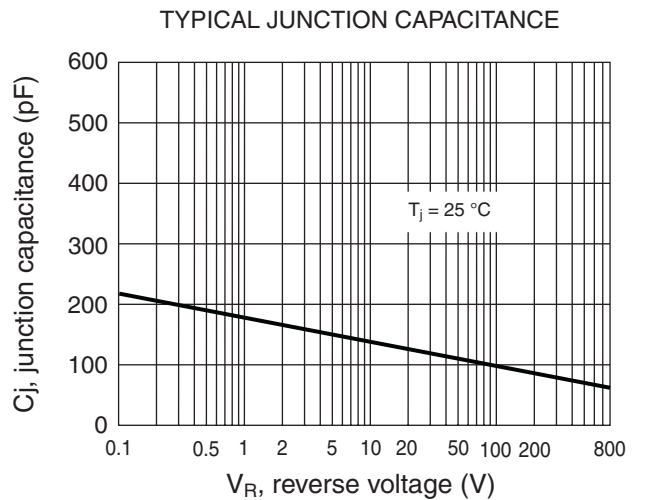
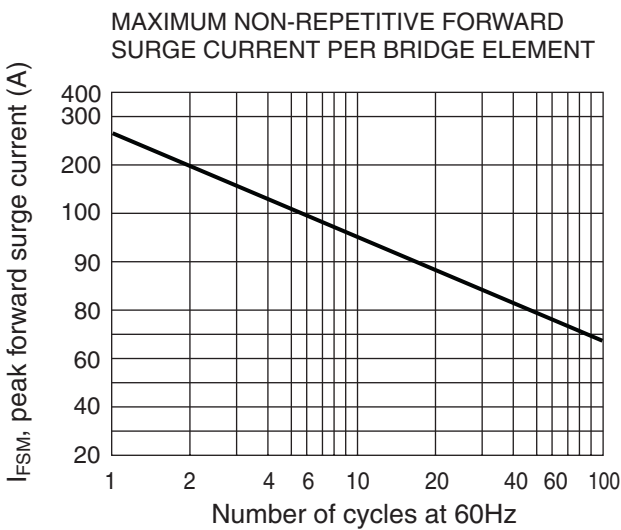
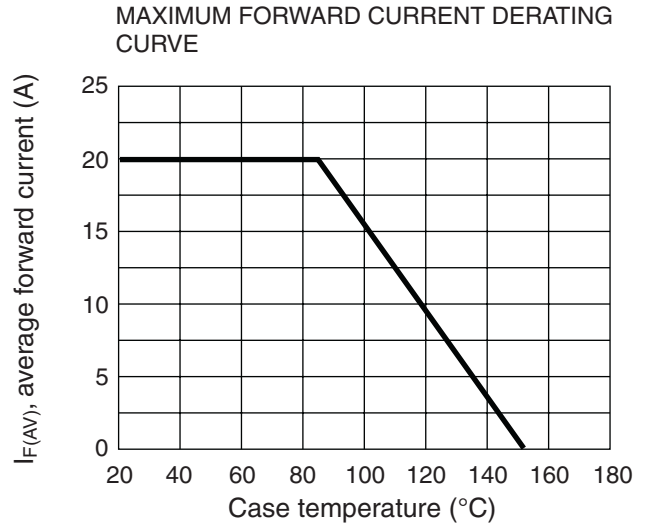
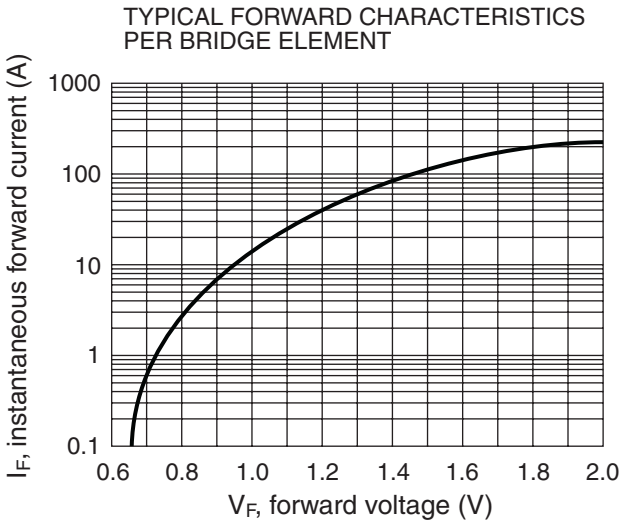

**20 Amp. Glass Passivated Single Phase In Line Bridge Rectifier****Revision History**

DATE	REVISION	DESCRIPTION OF CHANGES
15-Nov-2012	0	Original Data Sheet
27-Jan-2014	1	Changed ordering information
2-Jan-2023	2	Change ordering information

**Disclaimer**

All product, product specifications and data are subject to change without notice to improve reliability, function or design or otherwise.

Fagor Electrónica, S.Coop., its affiliates, agents, and employees, and all persons acting on its or their behalf (collectively, "Fagor"), disclaim any and all liability for any errors, inaccuracies or incompleteness contained in any datasheet or in any other disclosure relating to any product.

Fagor makes no warranty, representation or guarantee regarding the suitability of the products for any particular purpose or the continuing production of any product. To the maximum extent permitted by applicable law, Fagor disclaims (i) any and all liability arising out of the application or use of any product, (ii) any and all liability, including without limitation special, consequential or incidental damages, and (iii) any and all implied warranties, including warranties of fitness for particular purpose, non-infringement and merchantability.

Statements regarding the suitability of products for certain types of applications are based on Fagor's knowledge of typical requirements that are often placed on Fagor products in generic applications. Such statements are not binding statements about the suitability of products for a particular application. It is the customer's responsibility to validate that a particular product with the properties described in the product specification is suitable for use in a particular application. Parameters provided in datasheets and/or specifications may vary in different applications and performance may vary over time. All operating parameters, including typical parameters, must be validated for each customer application by the customer's technical experts. Product specifications do not expand or otherwise modify Fagor's terms and conditions of purchase, including but not limited to the warranty expressed therein.

Except as expressly indicated in writing, Fagor products are not designed for use in medical, life-saving, or life-sustaining applications or for any other application in which the failure of the Fagor product could result in personal injury or death. Customers using or selling Fagor products not expressly indicated for use in such applications do so at their own risk and agree to fully indemnify and hold Fagor and its distributors harmless from and against any and all claims, liabilities, expenses and damages arising or resulting in connection with such use or sale, including attorneys fees, even if such claim alleges that Fagor or its distributor was negligent regarding the design or manufacture of the part. Please contact authorized Fagor personnel to obtain written terms and conditions regarding products designed for such applications.

No license, express or implied, by estoppel or otherwise, to any intellectual property rights is granted by this document or by any conduct of Fagor, Product names and markings noted herein may be trademarks of their respective owners.