

# LM139/239/339 • LM139A/239A/339A

## Low Offset Voltage Quad Comparators

### Distinctive Characteristics

- Four high precision comparators
- Reduced VOS drift over temperature
- Eliminates need for dual supplies
- Allows sensing near ground
- Wide single supply voltage range or dual supplies  
2.0V<sub>DC</sub> to 36V<sub>DC</sub>  
±1.0V<sub>DC</sub> to ±18V<sub>DC</sub>
- Very low supply current drain (0.8mA)—independent of supply voltage (1.0mW/comparator) makes these comparators suitable for battery operation.
- Low input bias current – 35nA
- Low input offset current – 3.0nA and offset voltage – 2.0mV
- Input common-mode voltage range includes ground
- Differential input voltage range equal to the power supply voltage
- Low output saturation voltage  
1.0mV at 5.0μA  
60mV at 1.0mA
- Output voltage compatible with TTL, DTL, ECL, MOS and CMOS logic systems

### FUNCTIONAL DESCRIPTION

The AMD LM139, LM239, LM339, LM339A, LM239A and LM339A quad comparators are functionally, electrically and pin-for-pin equivalent to the National LM139, LM239, LM339, LM339A, LM239A and LM339A. This series of precision comparators consists of four independent voltage comparators which were specifically designed to operate from a single power supply over a wide range of voltages. Operation from split power supplies is also possible and the low power supply current drain is independent of the magnitude of the power supply voltage. These comparators have a unique characteristic

in that the input common-mode voltage range includes ground even though operated from a single power supply voltage.

Application areas include limit comparators, simple analog to digital converters; pulse, squarewave and time delay generators; wide range VCO; MOS clock timers; multivibrators and high voltage digital logic gates. The LM139/A series was designed to directly interface with TTL and CMOS. When operated from both plus and minus power supplies, the LM139/A will directly interface with MOS logic – where the lower power drain of the LM139/A is a distinct advantage over standard comparators.

### ORDERING INFORMATION\*

Part Number	Package Type	Temperature Range	Order Number
LM339	Hermetic DIP	0 to +70°C	LM339D
	Molded DIP	0 to +70°C	LM339N
	Dice	0 to +70°C	LD339
	Leadless	0 to +70°C	LM339L
LM239	Hermetic DIP	-25 to +85°C	LM239D
	Leadless	-25 to +85°C	LM239L
LM139	Hermetic DIP	-55 to +125°C	LM139D
	Flat Pack	-55 to +125°C	LM139F
	Dice	-55 to +125°C	LD139
	Leadless	-55 to +125°C	LM139L
LM339A	Hermetic DIP	0 to +70°C	LM339AD
	Molded DIP	0 to +70°C	LM339AN
	Dice	0 to +70°C	LD339A
	Leadless	0 to +70°C </td <td>LM339AL</td>	LM339AL
LM239A	Hermetic DIP	-25 to +85°C	LM239AD
	Leadless	-25 to +85°C	LM239AL
LM139A	Hermetic DIP	-55 to +125°C	LM139AD
	Flat Pack	-55 to +125°C	LM139AF
	Dice	-55 to +125°C	LD139A
	Leadless	-55 to +125°C	LM139AL

\*Also available with burn-in processing. To order add suffix B to part number.

### SCHEMATIC DIAGRAM

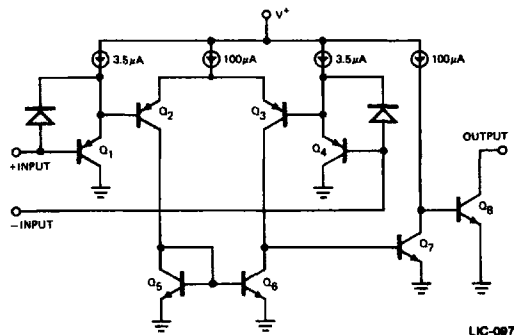

### CONNECTION DIAGRAMS – Top Views

Leadless Chip-Pak  
L-20-1

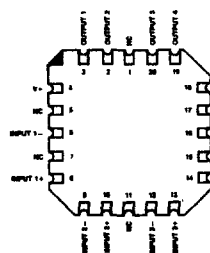

Hermetic and Molded DIP  
D-14-1

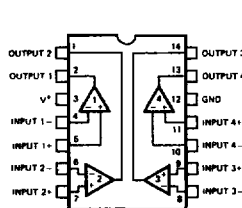

Note: Pin 1 is marked for orientation.

LIC-088

**LM139/239/339 • LM139A/239A/339A**  
**MAXIMUM RATINGS** (Above which the useful life may be impaired)

Supply Voltage, $V^+$	$36 V_{DC}$ or $\pm 18 V_{DC}$
Differential Input Voltage	$36 V_{DC}$
Input Voltage	$-0.3 V_{DC}$ to $+36 V_{DC}$
Power Dissipation (Note 1)	
Ceramic Dip	900 mW
Plastic Dip	570 mW
Flat Pack	800 mW

Output Short Circuit to GND (Note 2)	Continuous
Input Current ( $V_{in} = -0.3 V_{DC}$ ) (Note 3)	50 mA
Operating Temperature Range	
LM339/A	$0^\circ C$ to $+70^\circ C$
LM239/A	$-25^\circ C$ to $+85^\circ C$
LM139/A	$-55^\circ C$ to $+125^\circ C$
Storage Temperature Range	
	$-65^\circ C$ to $+150^\circ C$
Lead Temperature (Soldering, 10 seconds)	
	$300^\circ C$

**ELECTRICAL CHARACTERISTICS**  
( $V^+ = +5.0V_{DC}$ ) (Note 4)

Parameters	Test Conditions	LM239 LM339			LM139			LM239A LM339A			LM139A			Units
		Min.	Typ.	Max.	Min.	Typ.	Max.	Min.	Typ.	Max.	Mfg.	Typ.	Max.	
Input Offset Voltage	$T_A = +25^\circ C$ (Note 9)		-2.0	±5.0		+2.0	±5.0		+1.0	-2.0		+1.0	-2.0	mV <sub>DC</sub>
Input Bias Current (Note 5)	$I_{IN(+)}$ or $I_{IN(-)}$ with Output in Linear Range, $T_A = +25^\circ C$		25	250		25	100		25	250		25	100	nA <sub>DC</sub>
Input Offset Current	$I_{IN(+)} - I_{IN(-)}$ , $T_A = +25^\circ C$		±5.0	±50		±3.0	±25		±5.0	±50		±3.0	±25	nA <sub>DC</sub>
Input Common-Mode Voltage Range (Note 6)	$T_A = +25^\circ C$	0		$V^+ - 1.5$	0		$V^+ - 1.5$	0		$V^+ - 1.5$	0		$V^+ - 1.5$	V <sub>DC</sub>
Supply Current	$R_L = \infty$ on all Comparators $T_A = +25^\circ C$		0.8	2.0		0.8	2.0		0.8	2.0		0.8	2.0	mA <sub>DC</sub>
Voltage Gain	$R_L \geq 15k\Omega$ , $T_A = +25^\circ C$ , $V^+ = 15 V_{DC}$ (To Support Large $V_O$ Swing)		200			200		50	200		50	200		V/mV
Large Signal Response Time	$V_{IN} = TTL$ Logic Swing, $V_{REF} = -1.4V_{DC}$ , $V_{R_L} = 5.0V_{DC}$ , $R_L = 5.1k\Omega$ and $T_A = +25^\circ C$		300			300		300			300			ns
Response Time (Note 7)	$V_{R_L} = 5.0 V_{DC}$ and $R_L = 5.1 k\Omega$ $T_A = +25^\circ C$		1.3			1.3		1.3			1.3			µs
Output Sink Current	$V_{IN(-)} \geq +1.0 V_{DC}$ , $V_{IN(+)} = 0$ , and $V_O < -1.5 V_{DC}$ , $T_A = +25^\circ C$	6.0	16		6.0	16		6.0	16		6.0	16		mA <sub>DC</sub>
Saturation Voltage	$V_{IN(-)} \geq +1.0 V_{DC}$ , $V_{IN(+)} = 0$ , and $I_{sink} < 4.0 mA$ , $T_A = +25^\circ C$		250	400		250	400		250	400		250	400	mV <sub>DC</sub>
Output Leakage Current	$V_{IN(+)} \geq +1.0 V_{DC}$ , $V_{IN(-)} = 0$ and $V_O = 5.0 V_{DC}$ , $T_A = +25^\circ C$		0.1			0.1		0.1			0.1			nA <sub>DC</sub>
Input Offset Voltage	(Note 9)			9.0			9.0			4.0			4.0	mV <sub>DC</sub>
Input Offset Current	$I_{IN(+)} - I_{IN(-)}$			±150			±100			±150			±100	nA <sub>DC</sub>
Input Bias Current	$I_{IN(+)}$ or $I_{IN(-)}$ with Output in Linear Range			400			300			400			300	nA <sub>DC</sub>
Input Common-Mode Voltage Range		0		$V^+ - 2.0$	0		$V^+ - 2.0$	0		$V^+ - 2.0$	0		$V^+ - 2.0$	V <sub>DC</sub>
Saturation Voltage	$V_{IN(-)} \geq +1.0 V_{DC}$ , $V_{IN(+)} = 0$ and $I_{sink} \leq 4.0 mA$			700			700			700			700	mV <sub>DC</sub>
Output Leakage Current	$V_{IN(+)} \geq +1.0 V_{DC}$ , $V_{IN(-)} = 0$ and $V_O = 30 V_{DC}$			1.0			1.0			1.0			1.0	µA <sub>DC</sub>
Differential Input Voltage (Note 8)	Keep all $V_{INs} \geq 0 V_{DC}$ (or $V^-$ if used)			36			36			$V^+$			$V^+$	V <sub>DC</sub>

- Notes: 1. For high temperature operation, the LM339/A must be derated based on a  $+125^\circ C$  maximum junction temperature and a thermal resistance of  $+175^\circ C/W$  which applies for the device soldered in a printed circuit board, operating in a still air ambient. The LM239/A and LM139/A must be derated based on a  $+150^\circ C$  maximum junction temperature. The low bias dissipation and the ON-OFF characteristic of the outputs keeps the chip dissipation very small ( $P_d \leq 100mW$ ), provided the output transistors are allowed to saturate.
2. Short circuits from the output to  $V^+$  can cause excessive heating and eventual destruction. The maximum output current is approximately 20mA independent of the magnitude of  $V^+$ .
3. This input current will only exist when the voltage at any of the input leads is driven negative. It is due to the collector-base junction of the input PNP transistors becoming forward biased and thereby acting as input diode clamps. In addition to this diode action, there is also lateral NPN parasitic transistor action on the IC chip. This transistor action can cause the output voltages of the comparators to go to the  $V^+$  voltage level (or to ground for a large overdrive) for the time duration that an input is driven negative. This is not destructive and normal outputs states will re-establish when the input voltage, which was negative, again returns to a value greater than  $-0.3 V_{DC}$ .
4. These specifications apply for  $V^+ = +5.0 V_{DC}$  and  $-55^\circ C \leq T_A \leq +125^\circ C$ , unless otherwise stated. With the LM239/A all temperature specifications are limited to  $-25^\circ C \leq T_A \leq +85^\circ C$  and the LM339/A temperature specifications are limited to  $0^\circ C \leq T_A \leq +70^\circ C$ .
5. The direction of the input current is out of the IC due to the PNP input stage. This current is essentially constant, independent of the state of the output so no loading change exists on the reference or input lines.
6. The input common-mode voltage or either input signal voltage should not be allowed to go negative by more than 0.3V. The upper end of the common-mode voltage range is  $V^+ - 1.5V$ , but either or both inputs can go to  $+30 V_{DC}$  without damage.
7. The response time specified is for a 100mV input step with 5.0mV overdrive. 300ns can be achieved with larger overdrive signals, see typical performance characteristics section.
8. If the voltage applied to any input exceeds  $V^+$ , all four comparator outputs will go to the high voltage level. The low input voltage state must not be less than  $-0.3 V_{DC}$  (or  $0.3 V_{DC}$  below the magnitude of the negative power supply, if used).
9. At output switch point,  $V_O = 1.4 V_{DC}$ ,  $R_S = 0\Omega$  with  $V^-$  from  $5.0 V_{DC}$ ; and over the full input common mode range ( $0 V_{DC}$  to  $V^+ - 1.5 V_{DC}$ ).

## TYPICAL PERFORMANCE CHARACTERISTICS

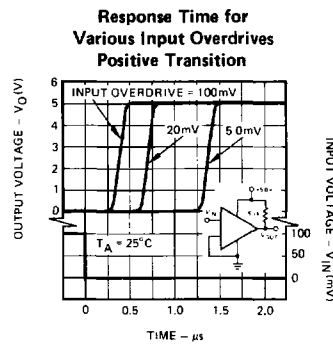
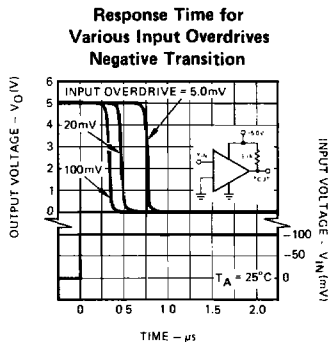
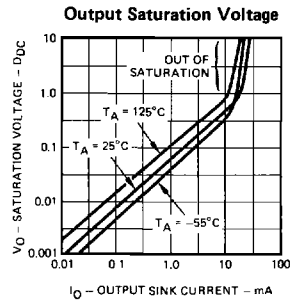
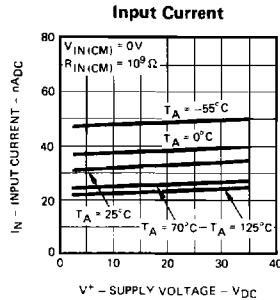
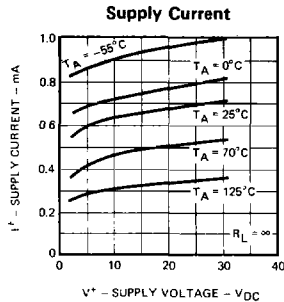

LIC-099

## APPLICATION HINTS

The LM139/A is a high gain, wide bandwidth device; which like most comparators, can easily oscillate if the output lead is inadvertently allowed to capacitively couple to the inputs via stray capacitance. The oscillation shows up only during the output voltage transition intervals as the comparator changes states. Power supply bypassing is not required to solve this problem. Standard PC board layout is helpful as it reduces stray input-output coupling. Lowering the input resistors to  $<10\text{k}\Omega$  reduces the feedback signal levels and finally, adding even a small amount (1 to 10 mV) of positive feedback (hysteresis) causes such a rapid transition that oscillations due to stray feedback are not possible. Simply socketing the I/C card attaching resistors to the pins will cause input-output oscillations during the small transition intervals unless hysteresis is used. If the input signal is a pulse waveform, with relatively fast rise and fall times, hysteresis is not required.

All pins of any unused comparators should be grounded.

The bias network of the LM139/A establishes a drain current which is independent of the magnitude of the power supply voltage over the range of from  $2V_{DC}$  to  $30 V_{DC}$ .

It is not normally necessary to use a bypass capacitor across the power supply line.

The differential input voltage may be larger than  $V^+$  without damaging the device. Protection should be provided to prevent the input voltages from going negative more than  $-0.3V_{DC}$  (at  $25^\circ\text{C}$ ). An input clamp diode and input resistor can be used as shown in the applications section.

The output of the LM139/A is the uncommitted collector of a grounded-emitter NPN output transistor. Several collectors can be tied together to provide an output OR'ing function. An output "pull-up" resistor can be connected to any available power supply voltage within the permitted supply voltage range and there is no restriction on this voltage due to the magnitude of the voltage which is applied to the  $V^+$  terminal of the LM139/A package. The output can also be used as a simple SPST switch to ground (when a "pull-up" resistor is not used). The amount of current which the output device can sink is limited by the drive available (which is independent of  $V^+$ ) and the  $\beta$  of this device. When the maximum current limit is reached (approximately 16 mA), the output transistor will come out of saturation and the output voltage will rise very rapidly. The output saturation voltage is limited by the approximately  $60\Omega r_{sat}$  of the output transistor. The low offset voltage of the output transistor (1 mV) allows the output to clamp very nearly to ground level for small load currents.

TYPICAL APPLICATIONS  
( $V^+ = 5.0V_{DC}$ )

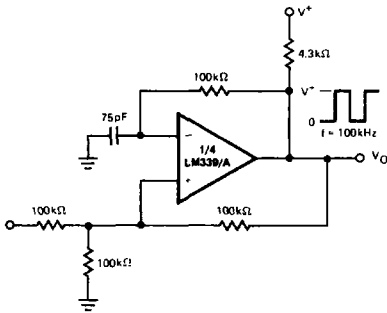

Squarewave Oscillator

LIC-100

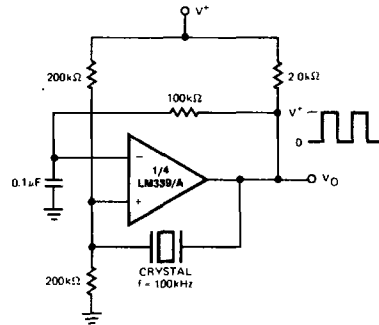

Crystal Controlled Oscillator

LIC-101

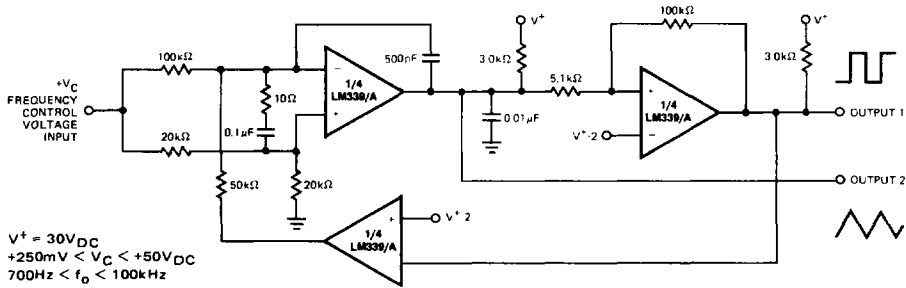

Two-Decade High-Frequency VCO

LIC-102

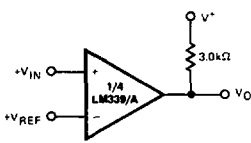

LIC-103

Basic Comparator

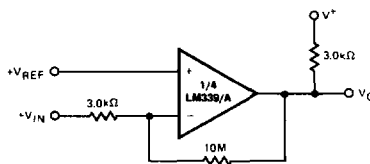

LIC-104

Non-Inverting Comparator with Hysteresis

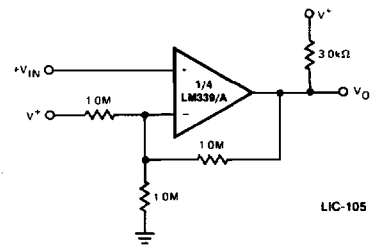

LIC-105

Inverting Comparator with Hysteresis

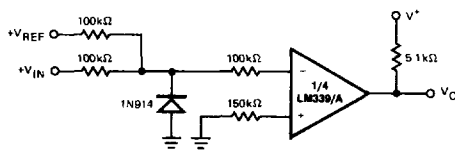

LIC-106

Comparing Input Voltages of Opposite Polarity

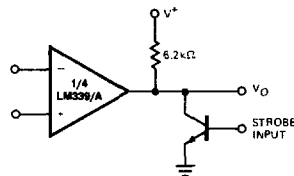

LIC-107

\*Or logic gate without pull-up resistor.

Output Strobing

TYPICAL APPLICATIONS (Cont.)  
( $V^+ = 5.0V_{DC}$ )

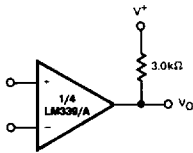

LIC-108

Basic Comparator

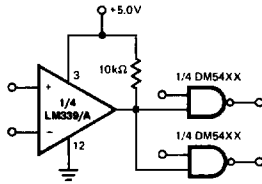

LIC-109

Driving TTL

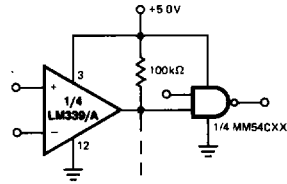

LIC-110

Driving CMOS

( $V^+ = 15V_{DC}$ )

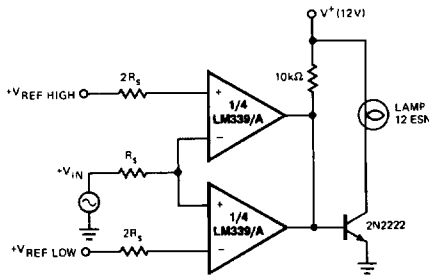

LIC-111

Limit Comparator

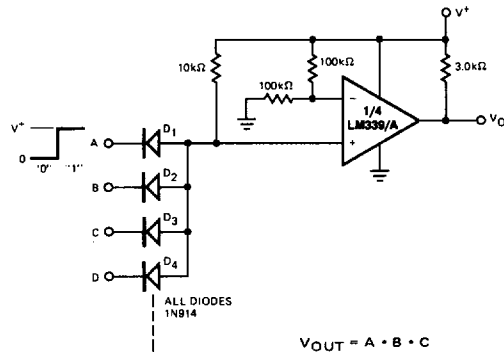

LIC-112

Large Fan-In AND Gate

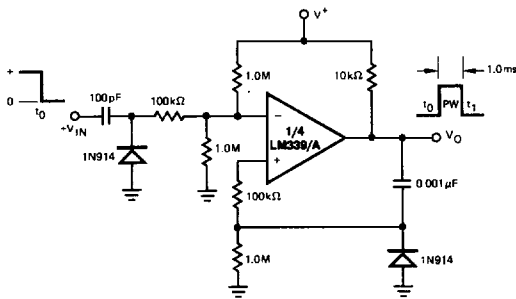

LIC-113

One-Shot Multivibrator

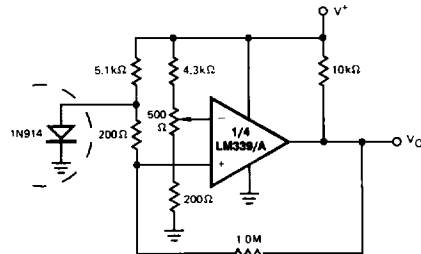

LIC-114

Remote Temperature Sensing



TYPICAL APPLICATIONS (Cont.)  
( $V^+ = 15V_{DC}$ )

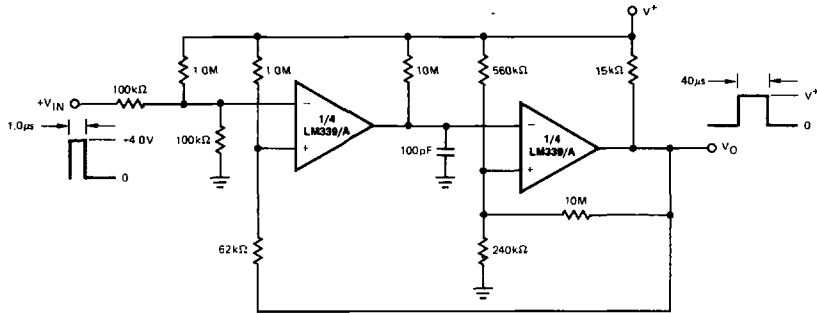

One-Shot Multivibrator with Input Lock Out

LIC-115

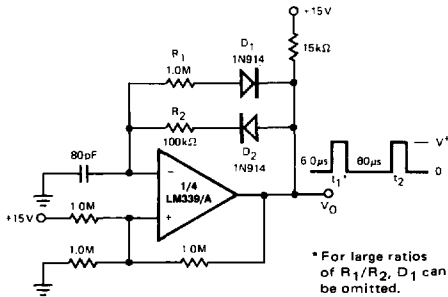

\* For large ratios of  $R_1/R_2$ ,  $D_1$  can be omitted.

LIC-116

Pulse Generator

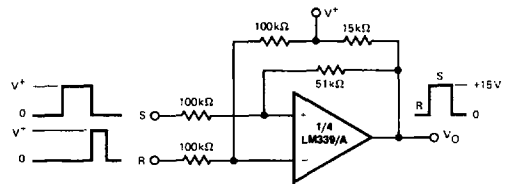

LIC-117

Bi-Stable Multivibrator

METALLIZATION AND PAD LAYOUT

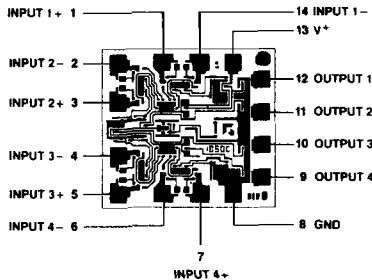

DIE SIZE 0.047" X 0.050"