

UNR6211/6212/6213/6214/6215/6216/6217/ 6218/6219/6210/621D/621E/621F/621K/621L (UN6211/6212/6213/6214/6215/6216/6217/6218/6219/ 6210/621D/621E/621F/621K/621L)

Silicon NPN epitaxial planer transistor

For digital circuits

Features

- Costs can be reduced through downsizing of the equipment and reduction of the number of parts.
- MT-1 type package, allowing supply with the radial taping.

Resistance by Part Number

	(R ₁)	(R ₂)
● UNR6211	10kΩ	10kΩ
● UNR6212	22kΩ	22kΩ
● UNR6213	47kΩ	47kΩ
● UNR6214	10kΩ	47kΩ
● UNR6215	10kΩ	—
● UNR6216	4.7kΩ	—
● UNR6217	22kΩ	—
● UNR6218	0.51kΩ	5.1kΩ
● UNR6219	1kΩ	10kΩ
● UNR6210	47kΩ	—
● UNR621D	47kΩ	10kΩ
● UNR621E	47kΩ	22kΩ
● UNR621F	4.7kΩ	10kΩ
● UNR621K	10kΩ	4.7kΩ
● UNR621L	4.7kΩ	4.7kΩ

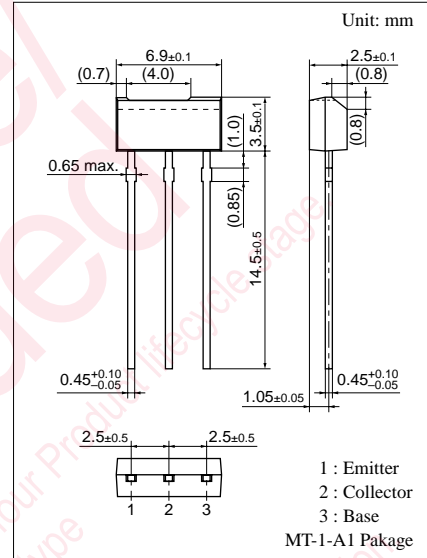

Internal Connection

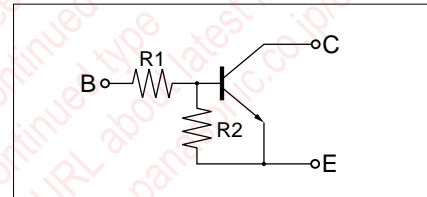

Absolute Maximum Ratings (T_a=25°C)

Parameter	Symbol	Ratings	Unit
Collector to base voltage	V _{CBO}	50	V
Collector to emitter voltage	V _{CEO}	50	V
Collector current	I _C	100	mA
Total power dissipation	P _T	400	mW
Junction temperature	T _j	150	°C
Storage temperature	T _{stg}	-55 to +150	°C

Note) The Part numbers in the Parenthesis show conventional part number.

UNR6211/6212/6213/6214/6215/6216/6217/6218/
Transistors with built-in Resistor 6219/6210/621D/621E/621F/621K/621L

■ Electrical Characteristics (T_a=25°C)

Parameter		Symbol	Conditions	min	typ	max	Unit	
Collector cutoff current		I _{CBO}	V _{CB} = 50V, I _E = 0			0.1	μA	
		I _{CEO}	V _{CE} = 50V, I _B = 0			0.5	μA	
Emitter cutoff current	UNR6211	I _{EBO}	V _{EB} = 6V, I _C = 0			0.5	mA	
	UNR6212/6214/621E/621D					0.2		
	UNR6213					0.1		
	UNR6215/6216/6217/6210					0.01		
	UNR621F/621K					1.0		
	UNR6219					1.5		
	UNR6218/621L					2.0		
Collector to base voltage		V _{CBO}	I _C = 10μA, I _E = 0	50			V	
Collector to emitter voltage		V _{CEO}	I _C = 2mA, I _B = 0	50			V	
Forward current transfer ratio	UNR6211	h _{FE}	V _{CE} = 10V, I _C = 5mA	35			V	
	UNR6212/621E			60				
	UNR6213/6214			80				
	UNR6215*/6216*/6217*/6210*			160		460		
	UNR621F/621D/6219			30				
	UNR6218/621K/621L			20				
Collector to emitter saturation voltage		V _{CE(sat)}	I _C = 10mA, I _B = 0.3mA			0.25	V	
Output voltage high level		V _{OH}	V _{CC} = 5V, V _B = 0.5V, R _L = 1kΩ	4.9			V	
Output voltage low level		V _{OL}	V _{CC} = 5V, V _B = 2.5V, R _L = 1kΩ			0.2	V	
			V _{OC} = 5V, V _B = 3.5V, R ₁ = 1kΩ			0.2		
			V _{CC} = 5V, V _B = 10V, R ₁ = 1kΩ			0.2		
			V _{CC} = 5V, V _B = 6V, R _L = 1kΩ			0.2		
Transition frequency		f _T	V _{CB} = 10V, I _E = -2mA, f = 200MHz		150		MHz	
Input resistance	UNR6211/6214/6215/621K	R ₁		(-30%)		10	(+30%)	kΩ
	UNR6212/6217					22		
	UNR6213/621D/621E/6210					47		
	UNR6216/621F/621L					4.7		
	UNR6218					0.51		
	UNR6219					1		
Resistance ratio	UNR6211/6212/6213/621L	R ₁ /R ₂				0.8	1.0	1.2
	UNR6214					0.17	0.21	0.25
	UNR6218/6219					0.08	0.1	0.12
	UNR621D					3.7	4.7	5.7
	UNR621E					1.7	2.14	2.6
	UNR621F					0.37	0.47	0.57
	UNR621K					1.7	2.13	2.6

* h_{FE} rank classification (UNR6215/6216/6217/6210)

Rank	Q	R	S
h _{FE}	160 to 260	210 to 340	290 to 460

Common characteristics chart

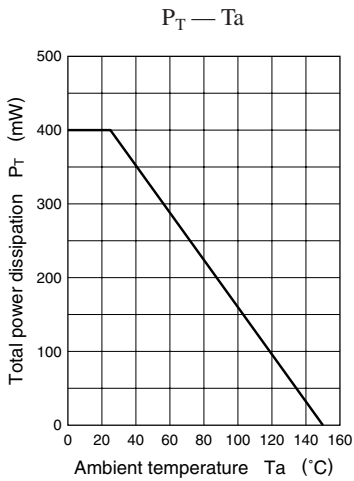

Characteristics charts of UNR6211

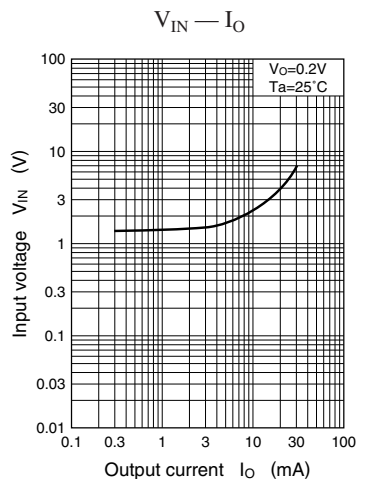
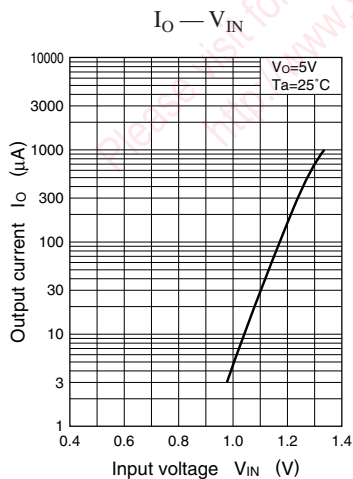
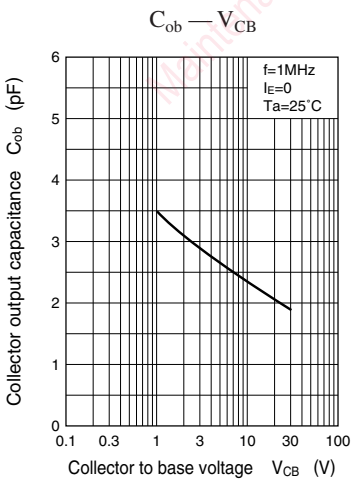
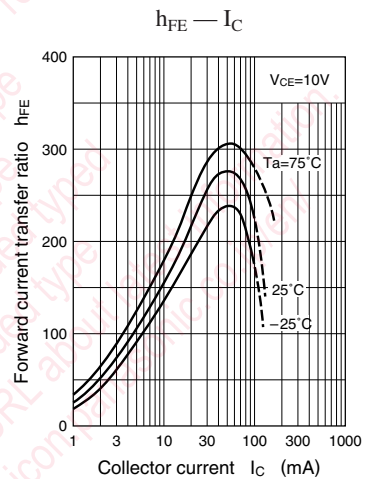
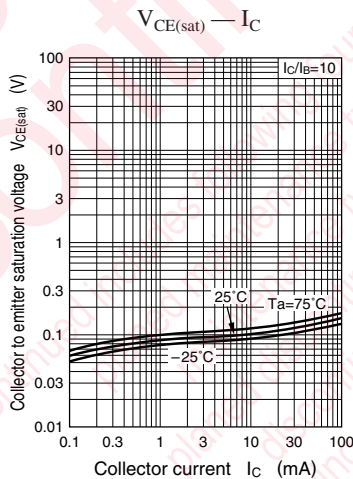
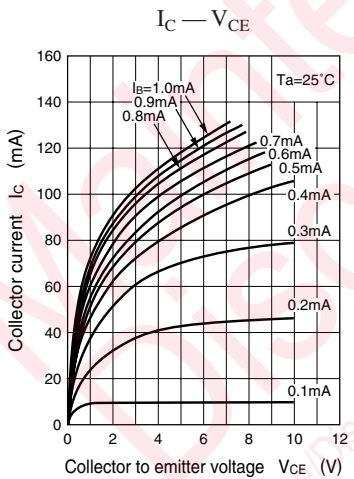

Characteristics charts of UNR6212

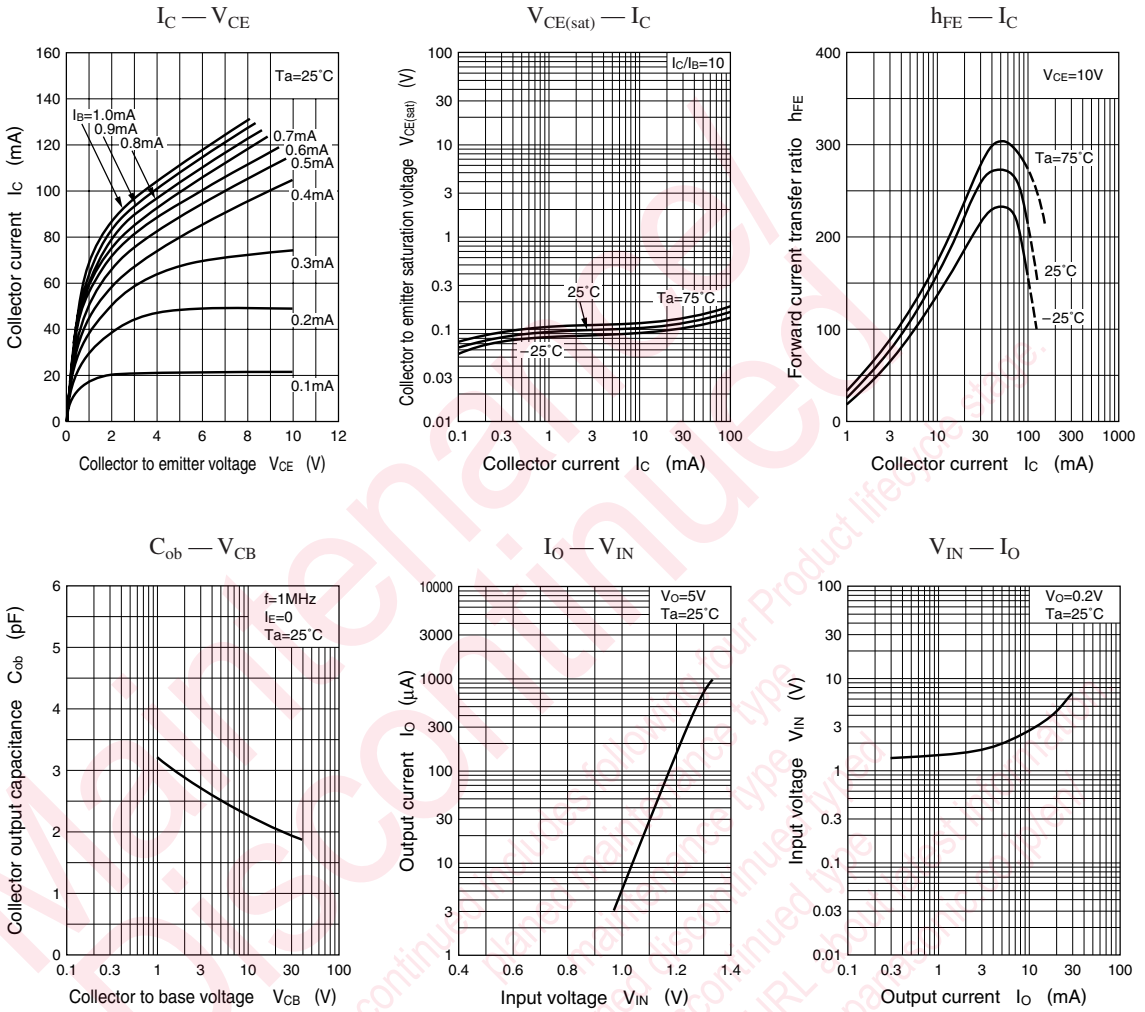

Characteristics charts of UNR6213

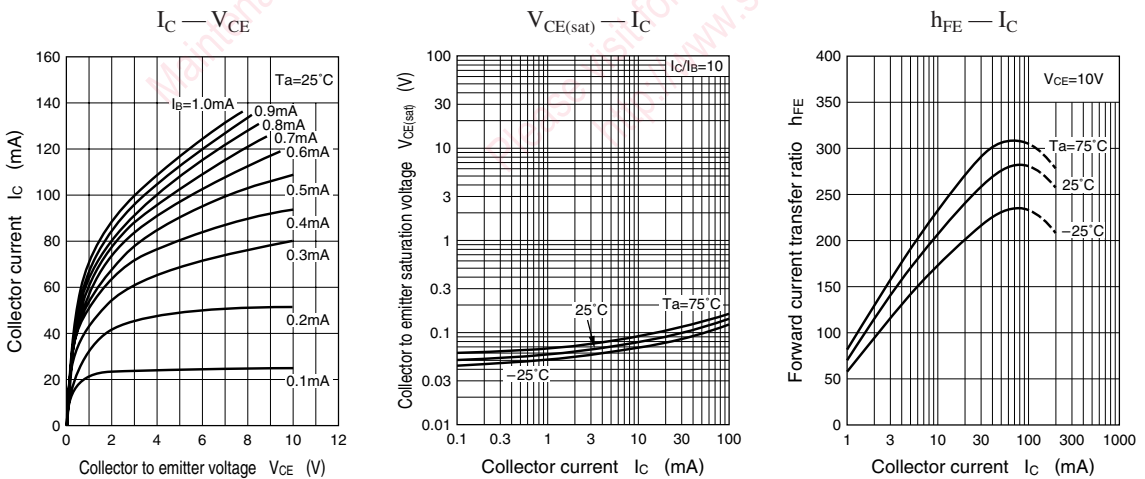

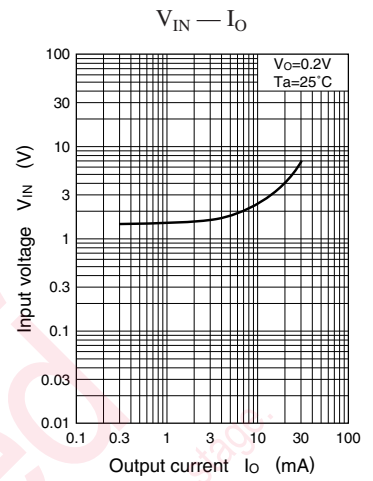
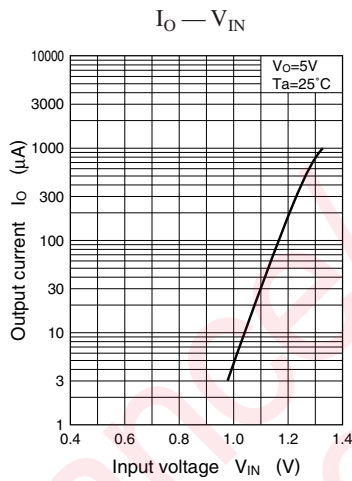
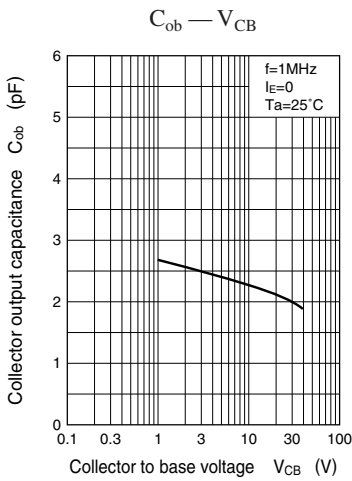

Characteristics charts of UNR6214

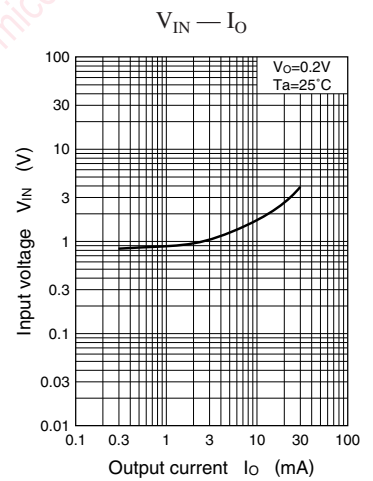
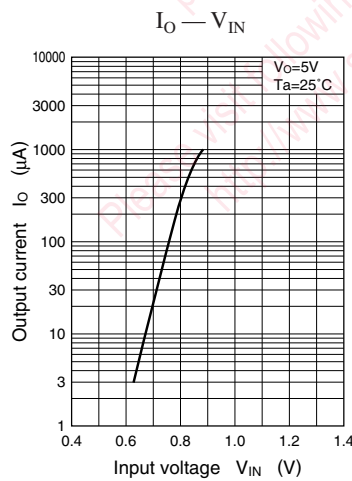
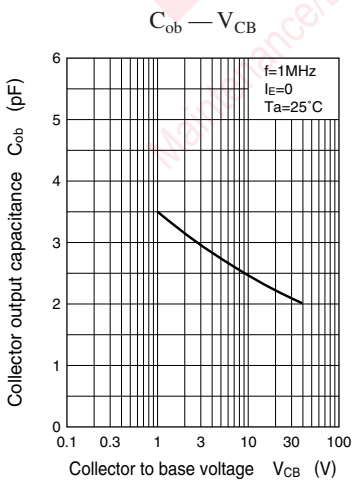
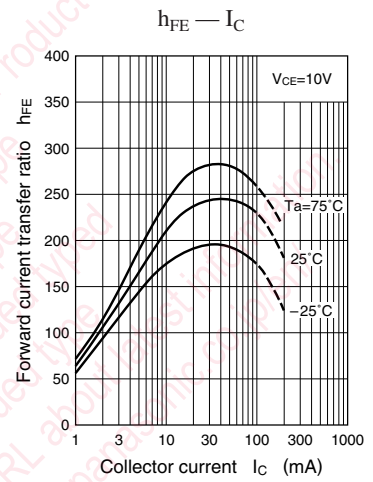
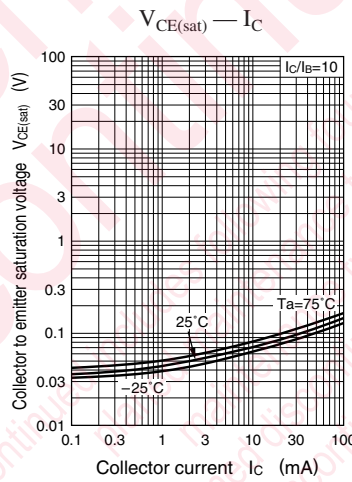
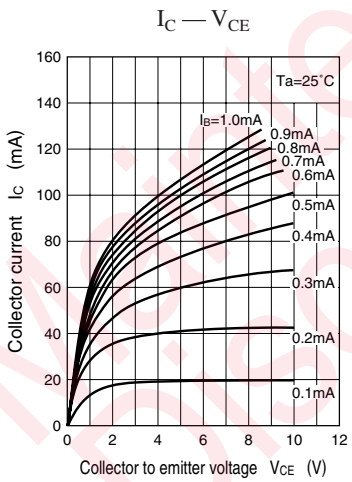

Characteristics charts of UNR6215

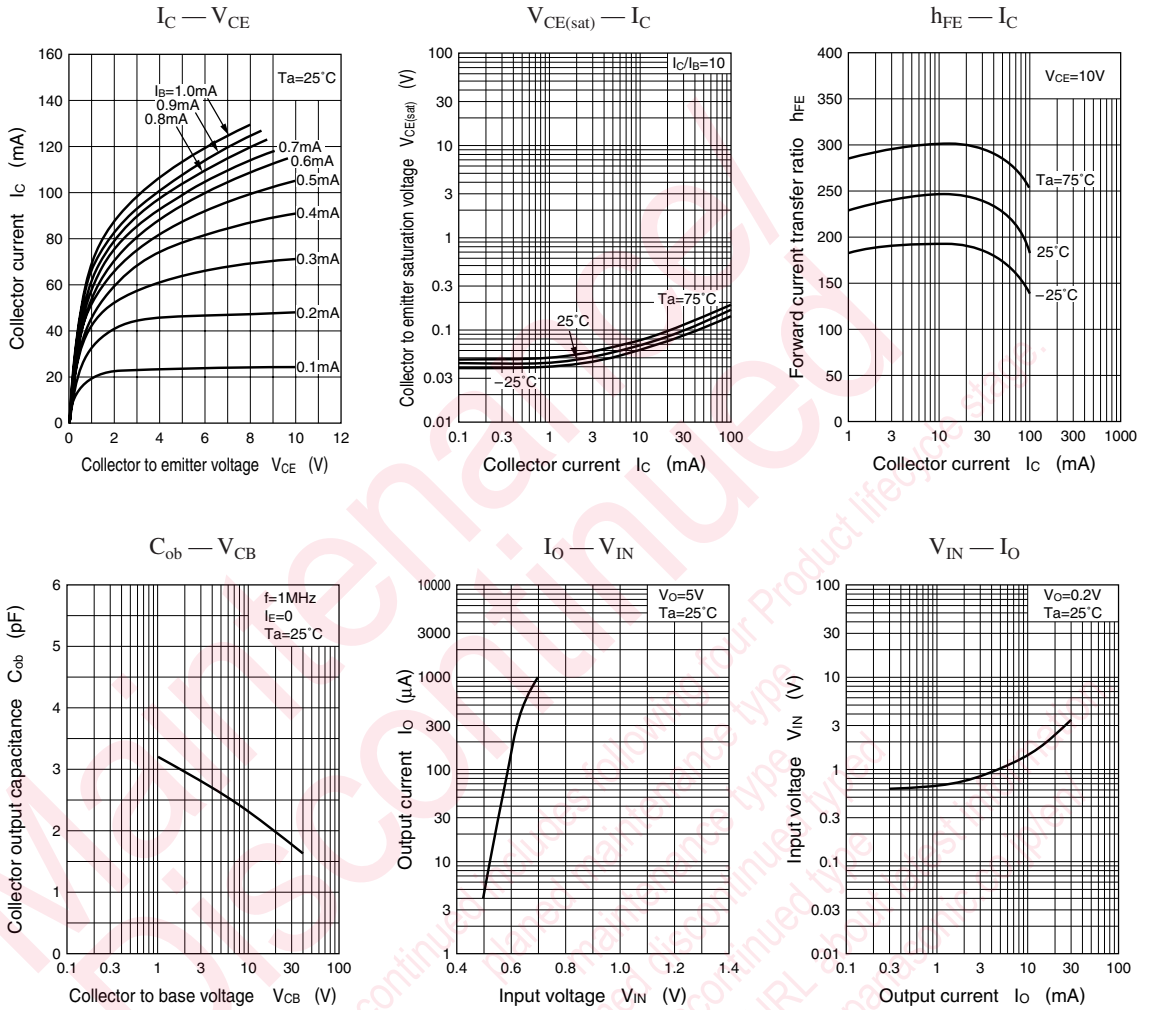

Characteristics charts of UNR6216

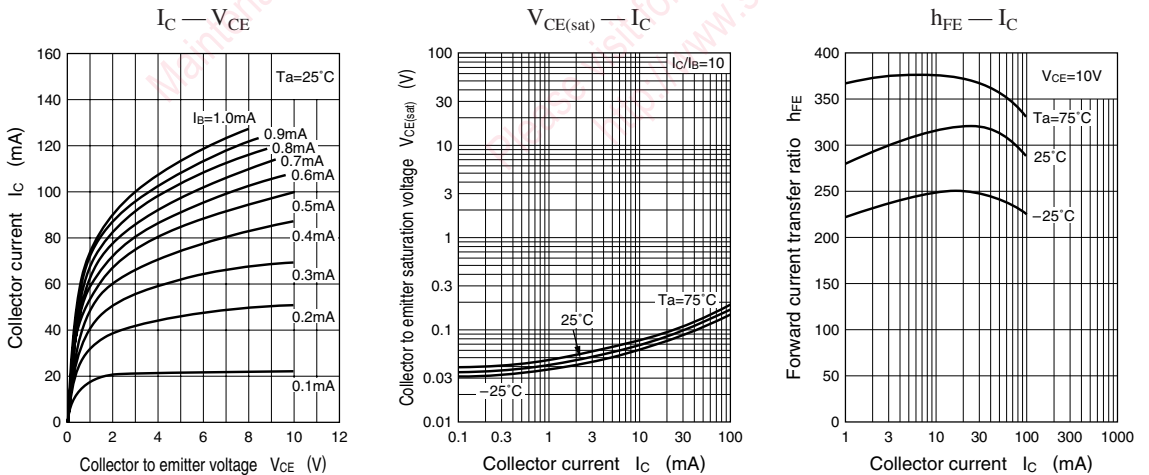

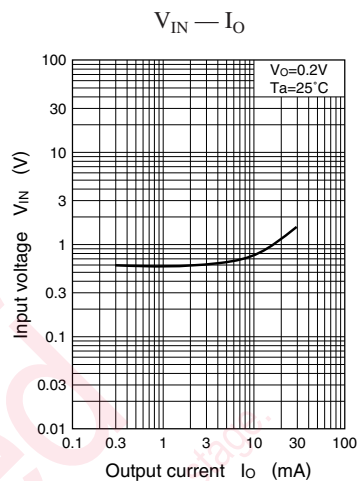
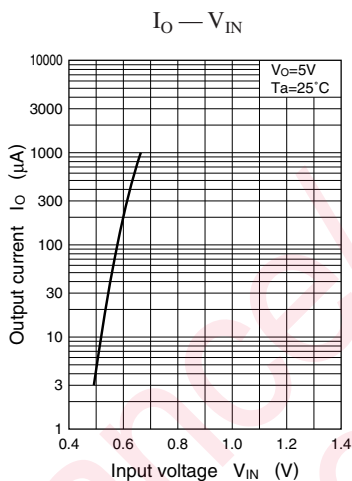
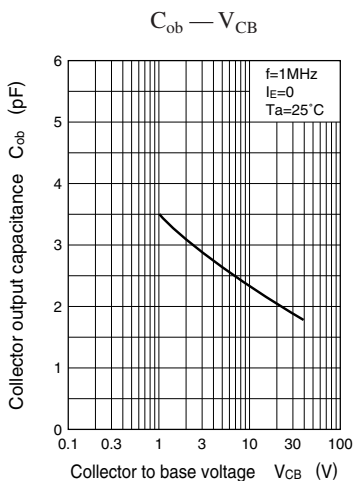

Characteristics charts of UNR6217

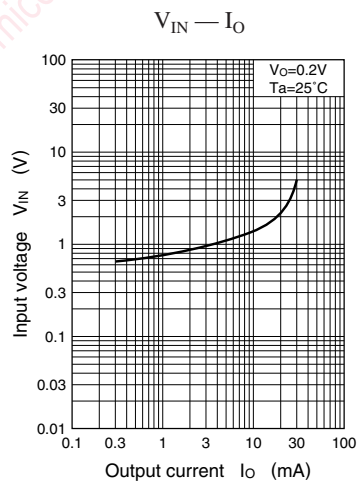
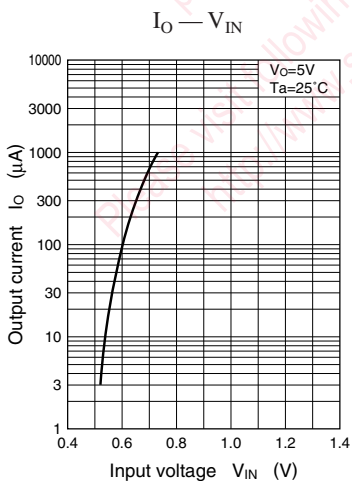
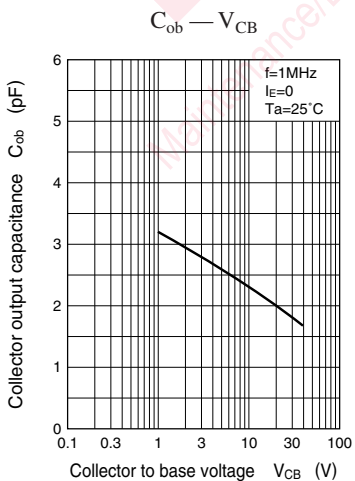
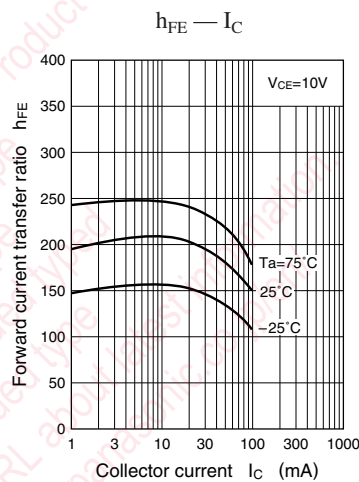
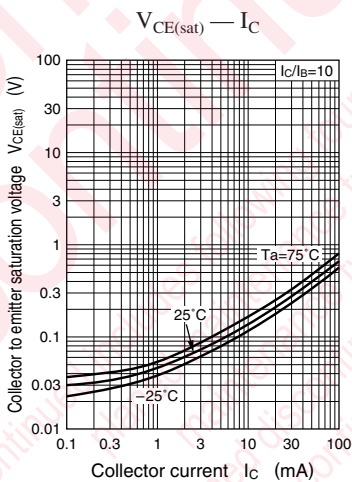
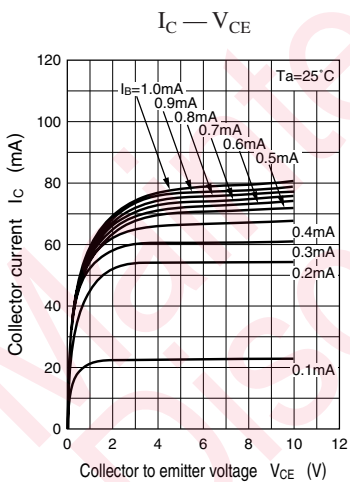

Characteristics charts of UNR6218

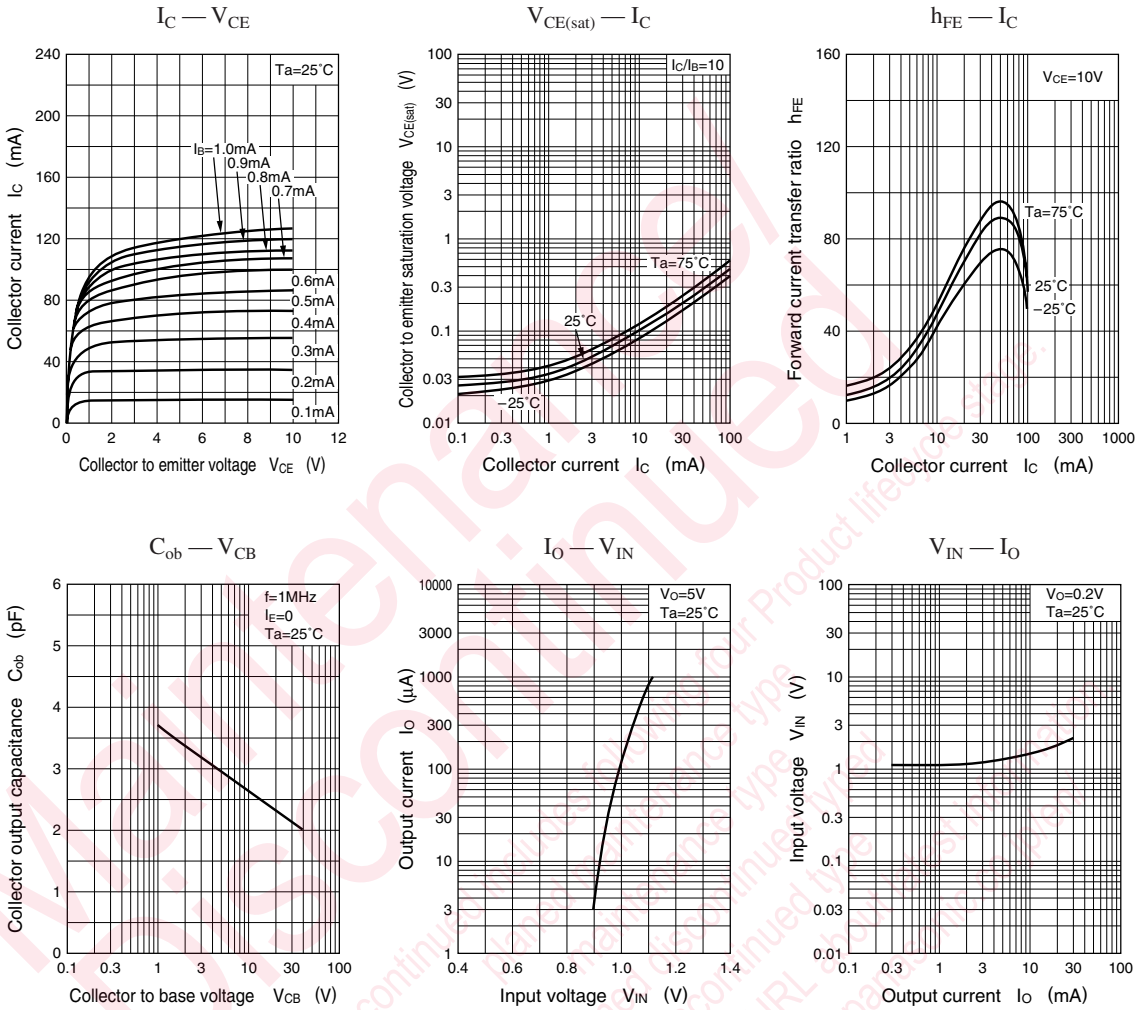

Characteristics charts of UNR6219

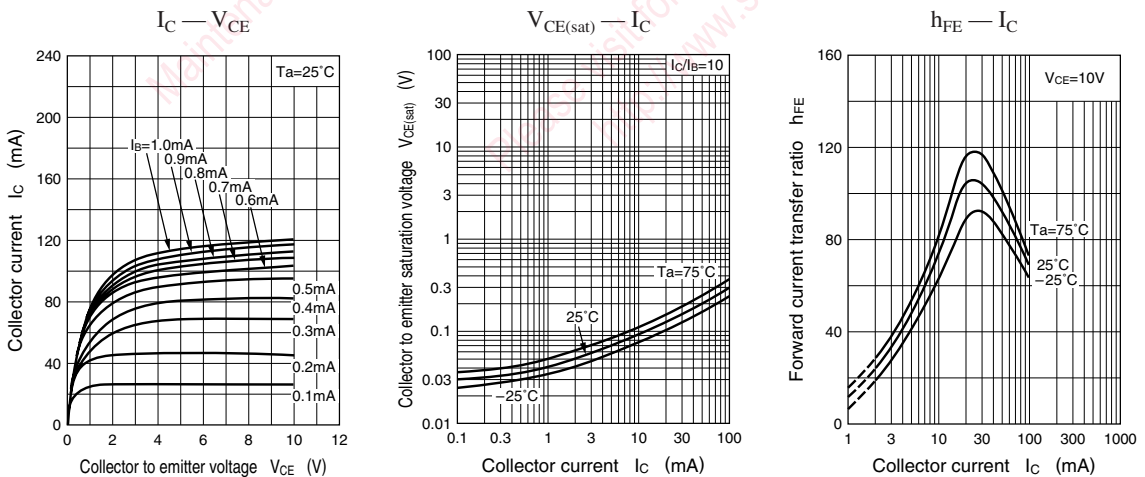

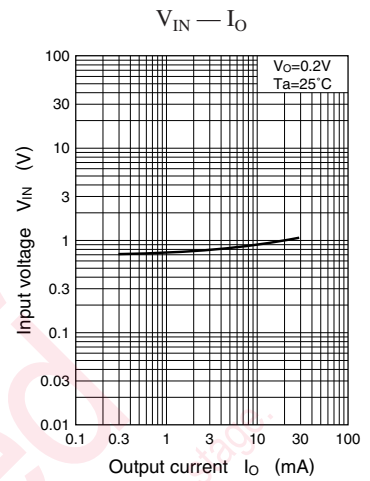
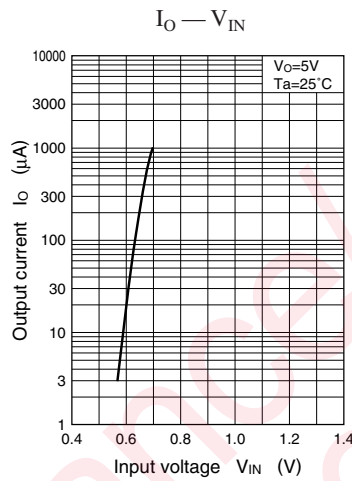
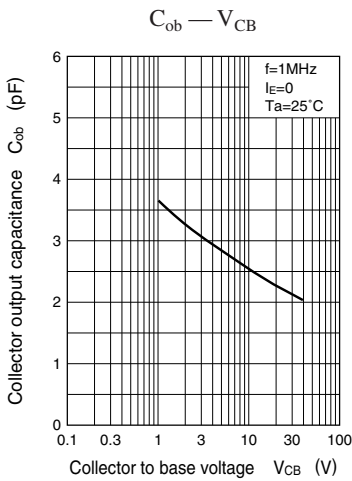

Characteristics charts of UNR6210

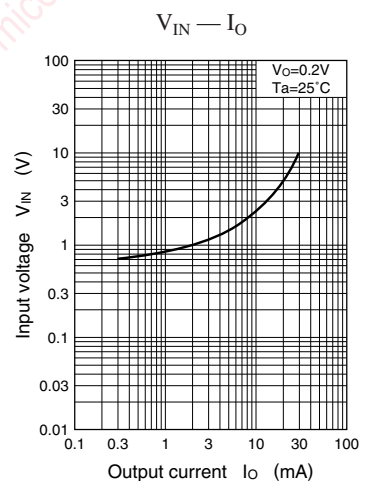
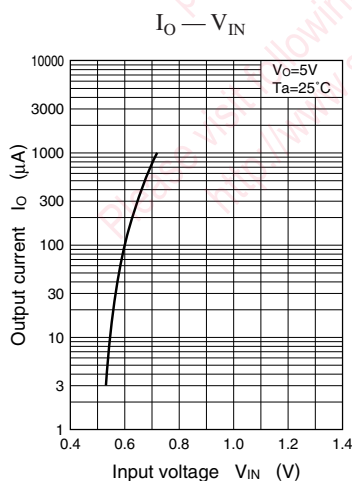
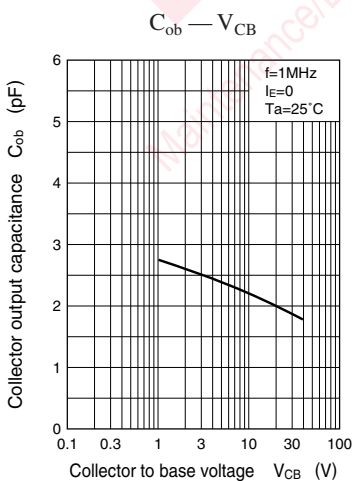
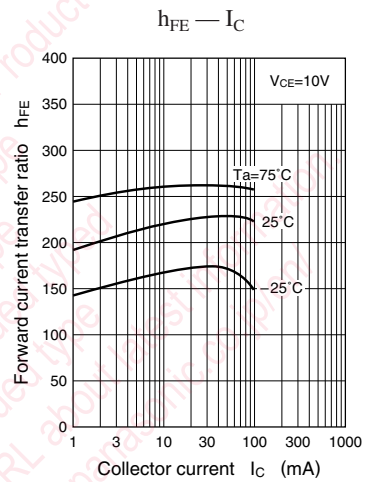
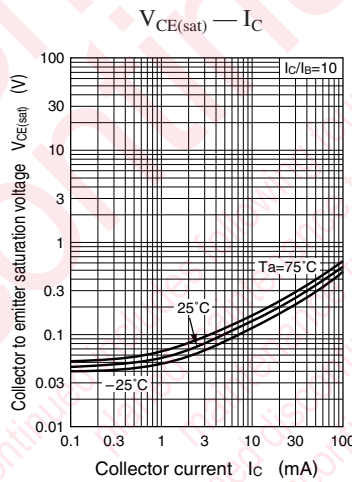
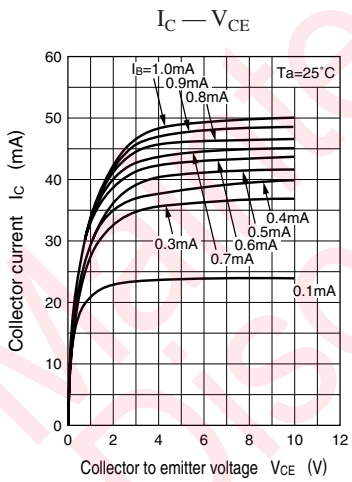

Characteristics charts of UNR621D

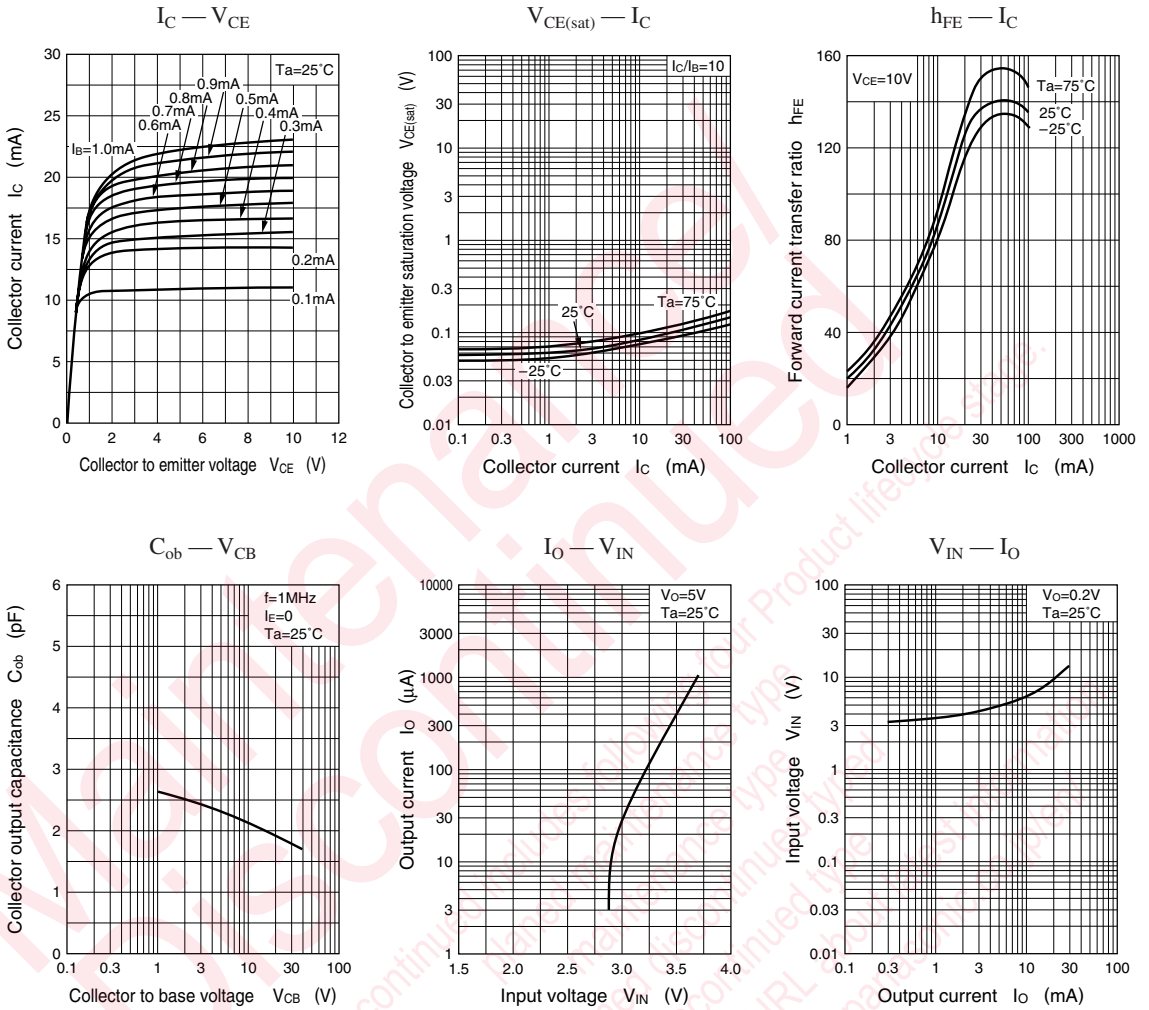

Characteristics charts of UNR621E

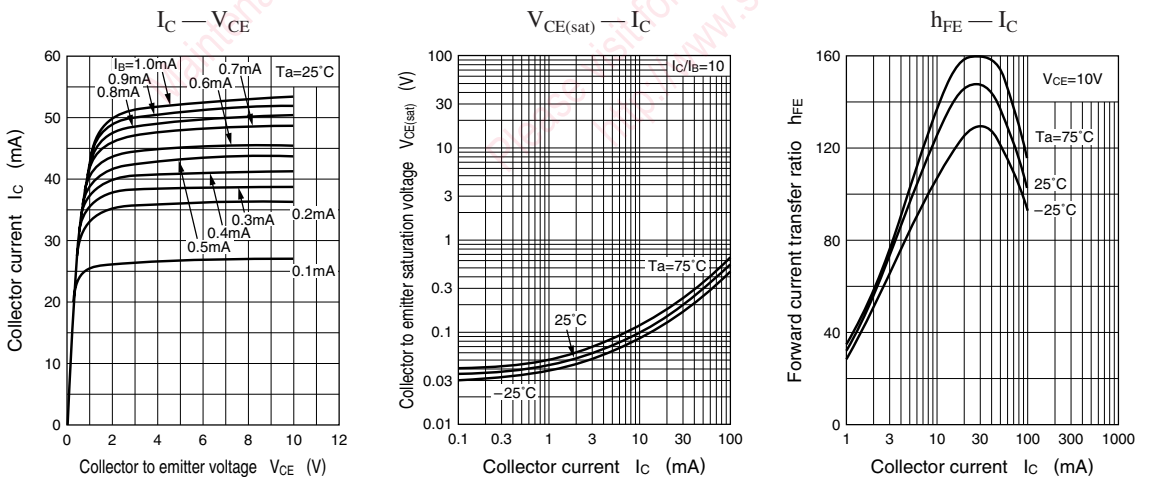

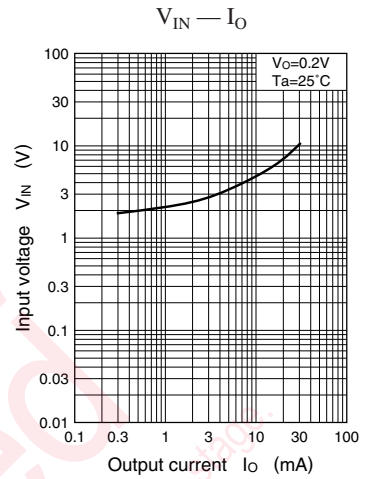
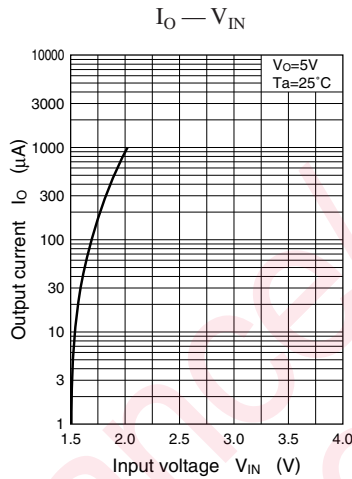
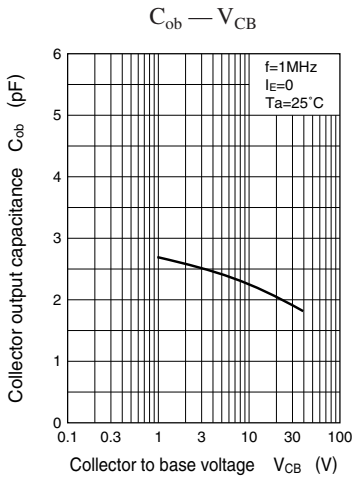

Characteristics charts of UNR621F

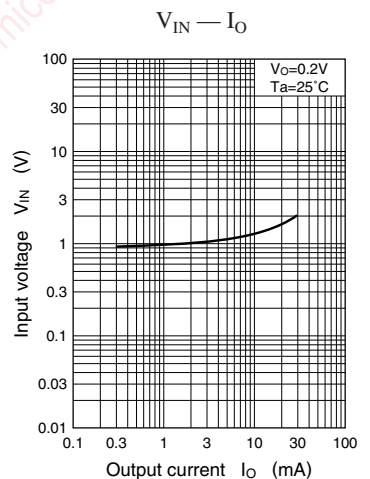
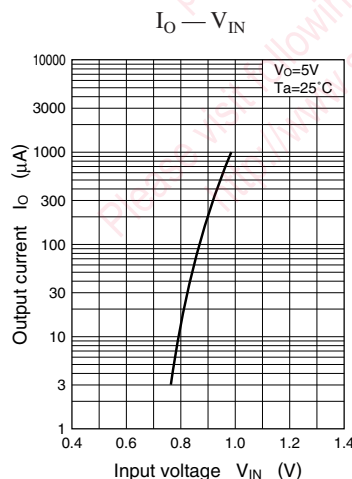
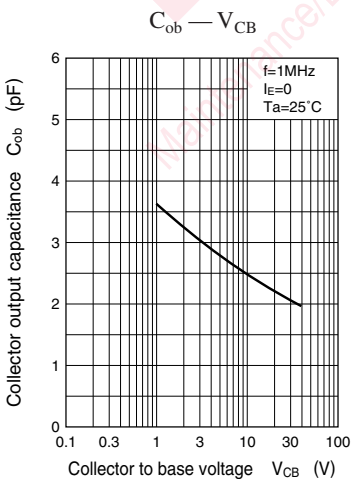
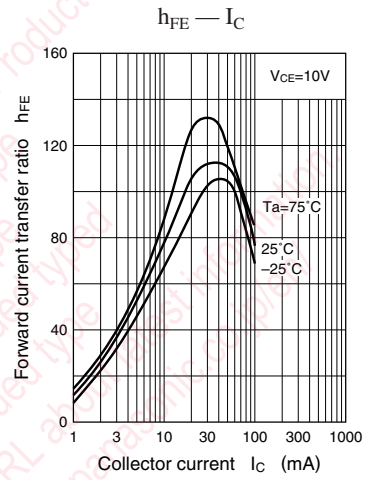
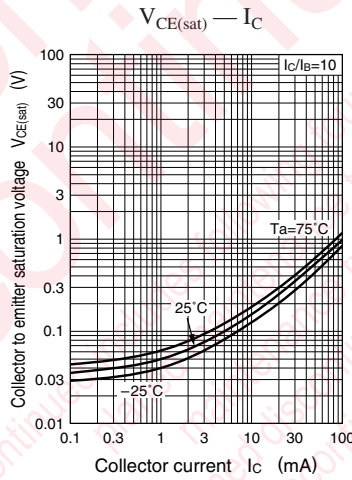
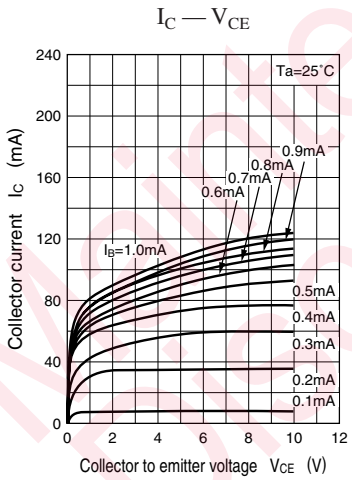

Characteristics charts of UNR621K

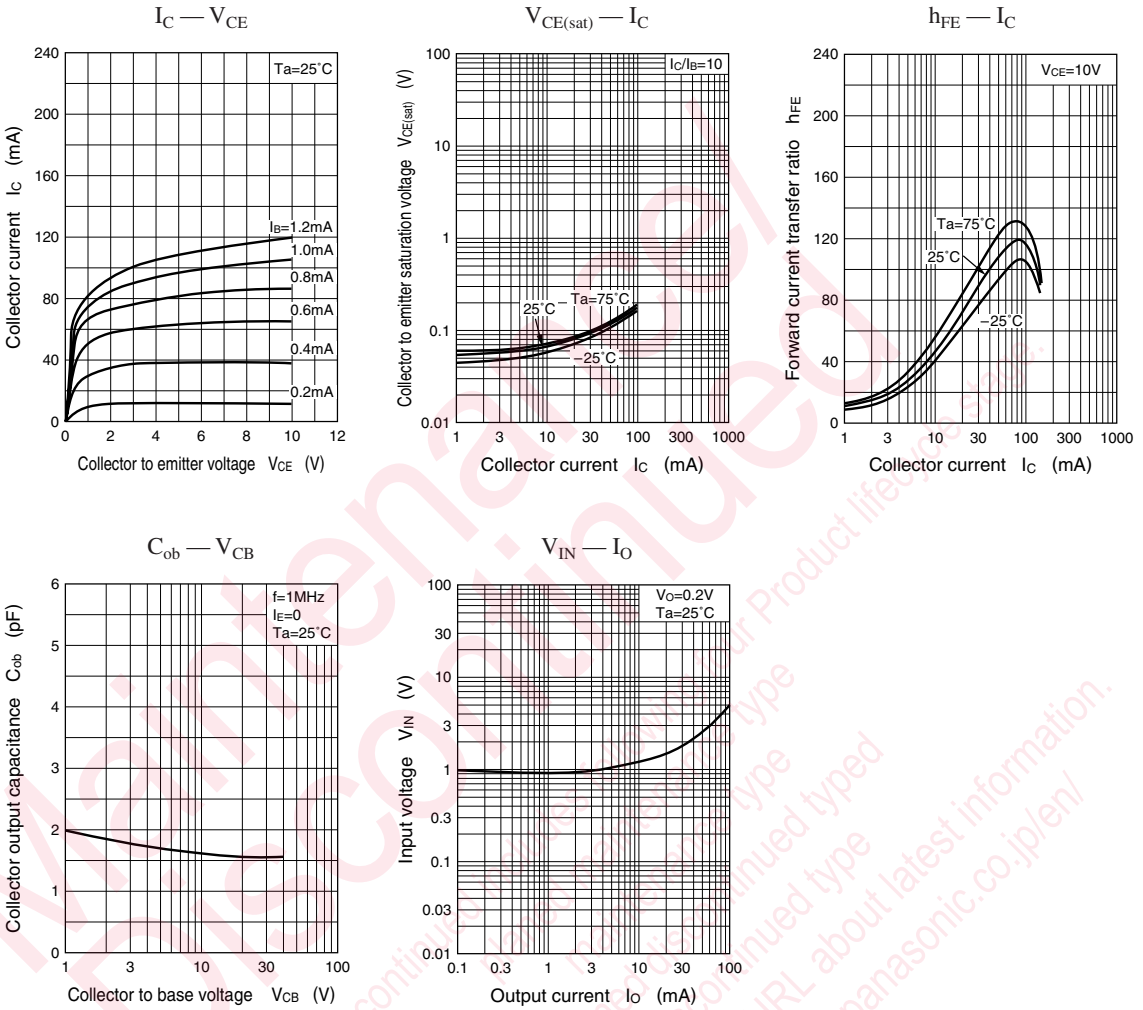

Characteristics charts of UNR621L

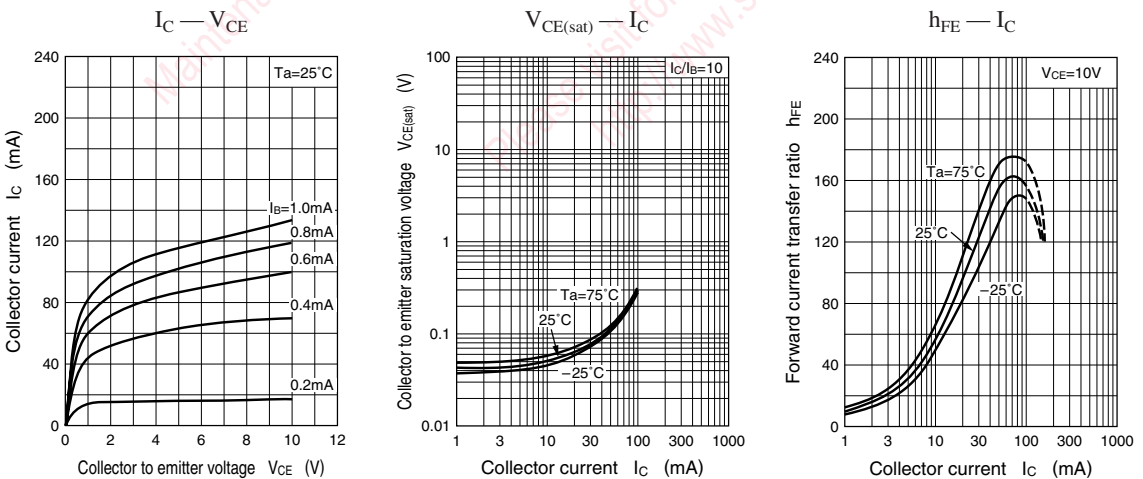

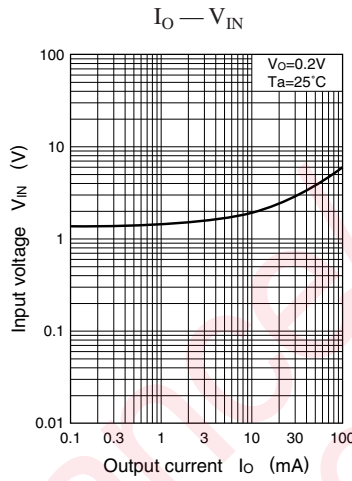
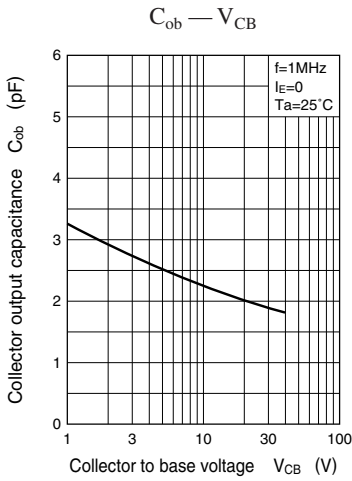

Maintenance/Discontinued

includes following four Product lifecycle stage.

- planned maintenance type
- maintenance type
- planned discontinued type
- discontinued type

Please visit following URL about latest information.

http://www.semicon.panasonic.co.jp/en/

Request for your special attention and precautions in using the technical information and semiconductors described in this book

- (1) If any of the products or technical information described in this book is to be exported or provided to non-residents, the laws and regulations of the exporting country, especially, those with regard to security export control, must be observed.
- (2) The technical information described in this book is intended only to show the main characteristics and application circuit examples of the products, and no license is granted under any intellectual property right or other right owned by our company or any other company. Therefore, no responsibility is assumed by our company as to the infringement upon any such right owned by any other company which may arise as a result of the use of technical information described in this book.
- (3) The products described in this book are intended to be used for standard applications or general electronic equipment (such as office equipment, communications equipment, measuring instruments and household appliances).
Consult our sales staff in advance for information on the following applications:
 - Special applications (such as for airplanes, aerospace, automobiles, traffic control equipment, combustion equipment, life support systems and safety devices) in which exceptional quality and reliability are required, or if the failure or malfunction of the products may directly jeopardize life or harm the human body.
 - Any applications other than the standard applications intended.
- (4) The products and product specifications described in this book are subject to change without notice for modification and/or improvement. At the final stage of your design, purchasing, or use of the products, therefore, ask for the most up-to-date Product Standards in advance to make sure that the latest specifications satisfy your requirements.
- (5) When designing your equipment, comply with the range of absolute maximum rating and the guaranteed operating conditions (operating power supply voltage and operating environment etc.). Especially, please be careful not to exceed the range of absolute maximum rating on the transient state, such as power-on, power-off and mode-switching. Otherwise, we will not be liable for any defect which may arise later in your equipment.
 - Even when the products are used within the guaranteed values, take into the consideration of incidence of break down and failure mode, possible to occur to semiconductor products. Measures on the systems such as redundant design, arresting the spread of fire or preventing glitch are recommended in order to prevent physical injury, fire, social damages, for example, by using the products.
- (6) Comply with the instructions for use in order to prevent breakdown and characteristics change due to external factors (ESD, EOS, thermal stress and mechanical stress) at the time of handling, mounting or at customer's process. When using products for which damp-proof packing is required, satisfy the conditions, such as shelf life and the elapsed time since first opening the packages.
- (7) This book may be not reprinted or reproduced whether wholly or partially, without the prior written permission of Matsushita Electric Industrial Co., Ltd.