

DUAL HIGH SPEED DRIVER

DESCRIPTION

The SG1644, 2644, 3644 is a dual non-inverting monolithic high speed driver. This device utilizes high voltage Schottky logic to convert TTL signals to high speed outputs up to 18V. The totem pole outputs have 3A peak current capability, which enables them to drive 1000pF loads in typically less than 25ns. These speeds make it ideal for driving power MOSFETs and other large capacitive loads requiring high speed switching.

In addition to the standard packages, Silicon General offers the 16 pin S.O.I.C. (DW-package) for commercial and industrial applications, and the Hermetic TO-66 (R-package) for military use. These packages offer improved thermal performance for applications requiring high frequencies and/or high peak currents.

FEATURES

- Totem pole outputs with 3.0A peak current capability.
- Supply voltage to 22V.
- Rise and fall times less than 25ns.
- Propagation delays less than 20ns.
- Non-inverting high-speed high-voltage Schottky logic.
- Efficient operation at high frequency.
- Available in:
 - 8 Pin Plastic and Ceramic DIP
 - 14 Pin Ceramic DIP
 - 16 Pin Plastic S.O.I.C.
 - 20 Pin LCC
 - TO-99
 - TO-66

HIGH RELIABILITY FEATURES - SG1644

- ◆ Available to MIL-STD-883
- ◆ Radiation data available
- ◆ LMI level "S" processing available

EQUIVALENT CIRCUIT SCHEMATIC

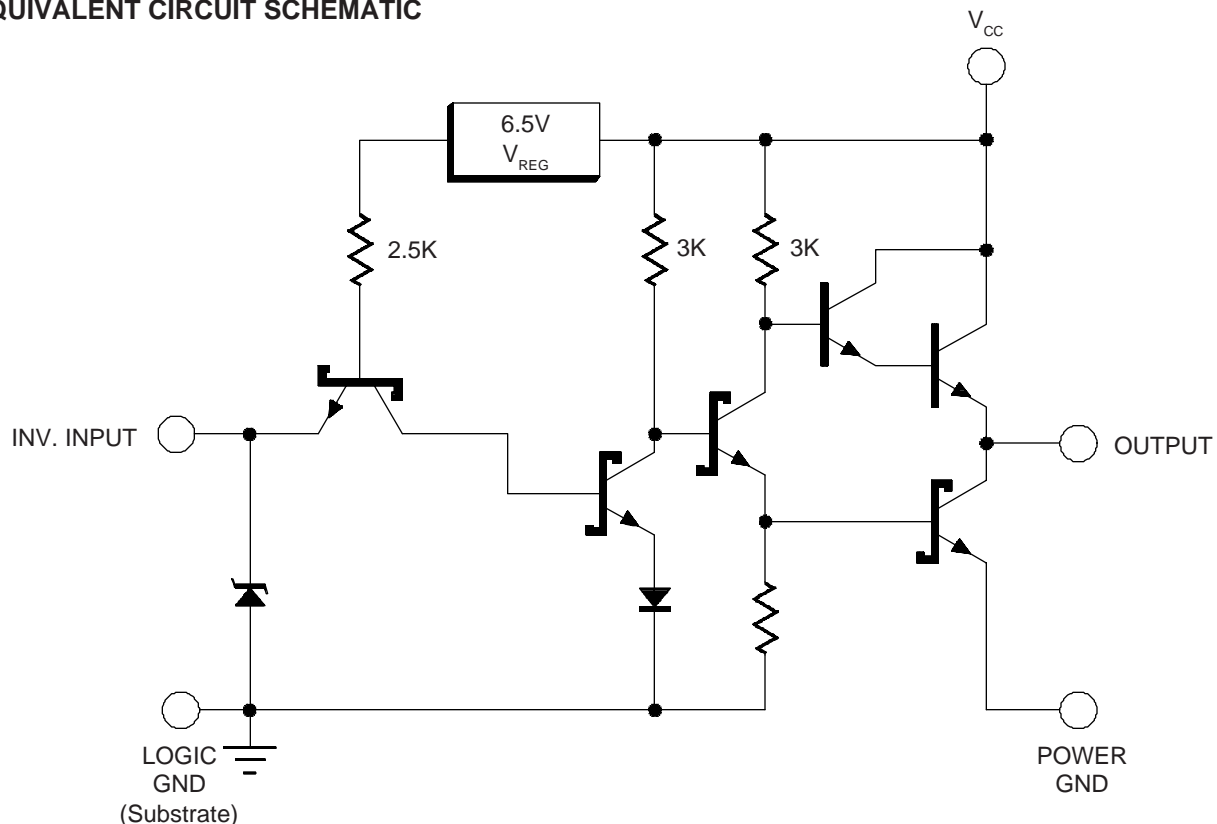

ABSOLUTE MAXIMUM RATINGS (Note 1)

Supply Voltage (V_{CC})	22V	Operating Junction Temperature	
Logic Input Voltage	7V	Hermetic (J, T, Y, R-Packages)	150°C
Source/Sink Output Current (Each Output)		Plastic (M, DW, L-Packages)	150°C
Continuous	$\pm 0.5A$	Storage Temperature Range	-65°C to 150°C
Pulse, 500ns	$\pm 3.0A$	Lead Temperature (Soldering, 10 Seconds)	300°C

Note 1. Exceeding these ratings could cause damage to the device. All voltages are with respect to ground. All currents are positive into the specified terminal.

RoHS Peak Package Solder Reflow Temp. (40 sec. max. exp.).... 260°C (+0, -5)

THERMAL DATA

J Package:

Thermal Resistance-Junction to Case, θ_{JC}	30°C/W
Thermal Resistance-Junction to Ambient, θ_{JA}	80°C/W

Y Package:

Thermal Resistance-Junction to Case, θ_{JC}	50°C/W
Thermal Resistance-Junction to Ambient, θ_{JA}	130°C/W

M Package:

Thermal Resistance-Junction to Case, θ_{JC}	60°C/W
Thermal Resistance-Junction to Ambient, θ_{JA}	95°C/W

DW Package:

Thermal Resistance-Junction to Case, θ_{JC}	40°C/W
Thermal Resistance-Junction to Ambient, θ_{JA}	95°C/W

T Package:

Thermal Resistance-Junction to Case, θ_{JC}	25°C/W
Thermal Resistance-Junction to Ambient, θ_{JA}	130°C/W

R Package:

Thermal Resistance-Junction to Case, θ_{JC}	5.0°C/W
Thermal Resistance-Junction to Ambient, θ_{JA}	40°C/W

L Package:

Thermal Resistance-Junction to Case, θ_{JC}	35°C/W
Thermal Resistance-Junction to Ambient, θ_{JA}	120°C/W

Note A. Junction Temperature Calculation: $T_J = T_A + (P_D \times \theta_{JA})$.

Note B. The above numbers for θ_{JC} are maximums for the limiting thermal resistance of the package in a standard mounting configuration. The θ_{JA} numbers are meant to be guidelines for the thermal performance of the device/pc-board system. All of the above assume no ambient airflow.

RECOMMENDED OPERATING CONDITIONS (Note 2)

Supply Voltage (V_{CC})	4.5V to 20V (Note 3)
Frequency Range	DC to 1.5MHz
Peak Pulse Current	$\pm 3A$
Logic Input Voltage	-0.5 to 5.5V

Operating Ambient Temperature Range (T_A)

SG1644	-55°C to 125°C
SG2644	-25°C to 85°C
SG3644	0°C to 70°C

Note 2. Range over which the device is functional.

Note 3. AC performance has been optimized for $V_{CC} = 8V$ to 20V.

ELECTRICAL CHARACTERISTICS

(Unless otherwise specified, these specifications apply over the operating ambient temperatures for SG1644 with $-55^\circ\text{C} \leq T_A \leq 125^\circ\text{C}$, SG2644 with $-25^\circ\text{C} \leq T_A \leq 85^\circ\text{C}$, SG3644 with $0^\circ\text{C} \leq T_A \leq 70^\circ\text{C}$, and $V_{CC} = 20V$. Low duty cycle pulse testing techniques are used which maintains junction and case temperatures equal to the ambient temperature.)

Parameter	Test Conditions	SG1644/2644/3644			Units
		Min.	Typ.	Max.	
Static Characteristics					
Logic 1 Input Voltage		2.0			V
Logic 0 Input Voltage				0.7	V
Input High Current	$V_{IN} = 2.4V$			500	μA
Input High Current	$V_{IN} = 5.5V$			1.0	mA
Input Low Current	$V_{IN} = 0V$			-4	mA
Input Clamp Voltage	$I_{IN} = -10mA$			-1.5	V
Output High Voltage (Note 4)	$I_{OUT} = -200mA$	$V_{CC}-3$			V
Output Low Voltage (Note 4)	$I_{OUT} = 200mA$			1.0	V
Supply Current Outputs Low	$V_{IN} = 0V$ (both inputs)		18	27	mA
Supply Current Outputs High	$V_{IN} = 2.4V$ (both inputs)		7.5	12	mA

Note 4. $V_{CC} = 10V$ to 20V.

ELECTRICAL CHARACTERISTICS (continued)

Parameter	Test Conditions (Figure 1)	SG1644/2644/3644 T _A = 25°C			SG1644 T _A = -55°C to 125°C			Units
		Min.	Typ.	Max.	Min.	Typ.	Max.	
Dynamic Characteristics (Note 6)								
Propagation Delay High-Low (TPHL)	C _L = 1000pF (Note 5)			30			40	ns
	C _L = 2500pF		26	35			50	ns
Propagation Delay Low-High (TPLH)	C _L = 1000pF (Note 5)			25			30	ns
	C _L = 2500pF		18	30			40	ns
Rise Time (TTLH)	C _L = 1000pF (Note 5)			30			35	ns
	C _L = 2500pF		30	40			50	ns
Fall Time (TTHL)	C _L = 1000pF (Note 5)			25			30	ns
	C _L = 2500pF		30	40			50	ns
Supply Current (I _{CC}) (both outputs)	C _L = 2500pF, Freq. = 200KHz Duty Cycle = 50%		30	35			40	mA

Note 5. These parameters, specified at 1000pF, although guaranteed over recommended operating conditions, are not tested in production.

Note 6. V_{CC} = 15V.

AC TEST CIRCUIT AND SWITCHING TIME WAVEFORMS - FIGURE 1

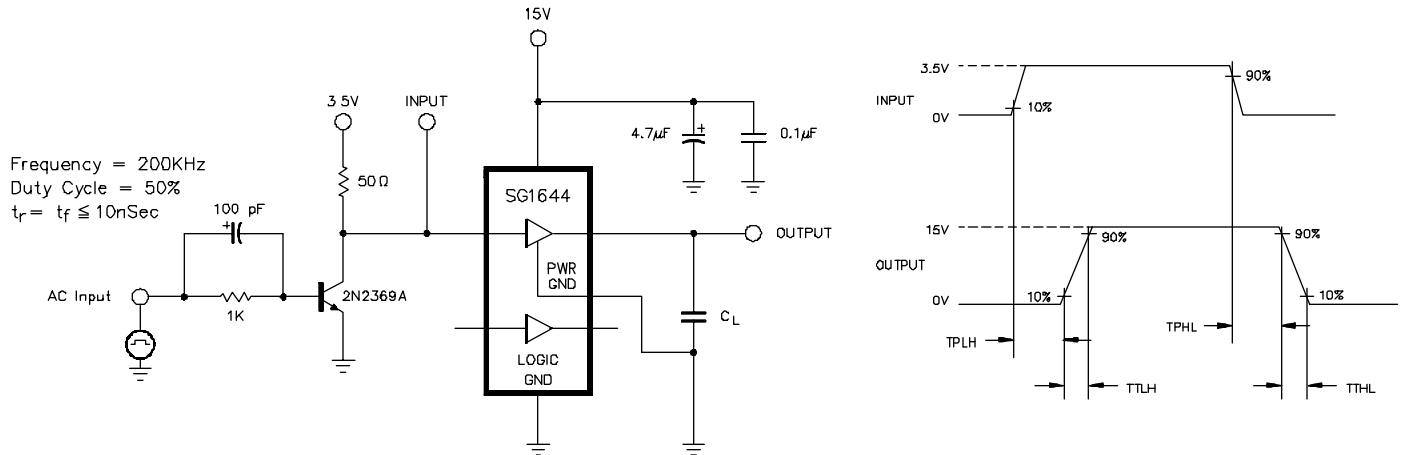

CHARACTERISTIC CURVES

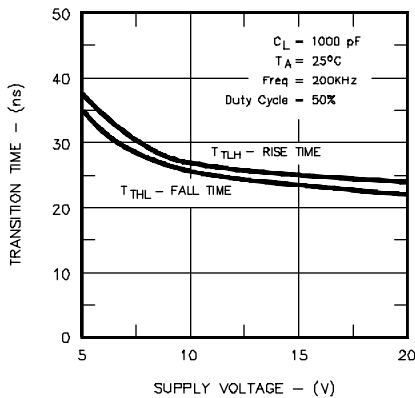

FIGURE 2. TRANSITION TIMES VS. SUPPLY VOLTAGE

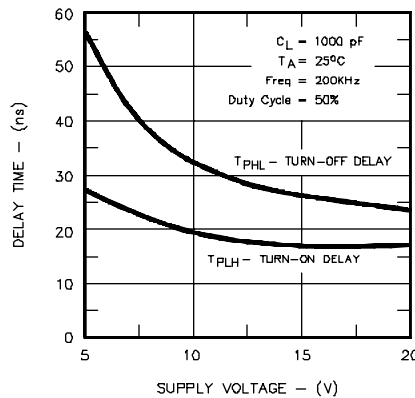

FIGURE 3. PROPAGATION DELAY VS. SUPPLY VOLTAGE

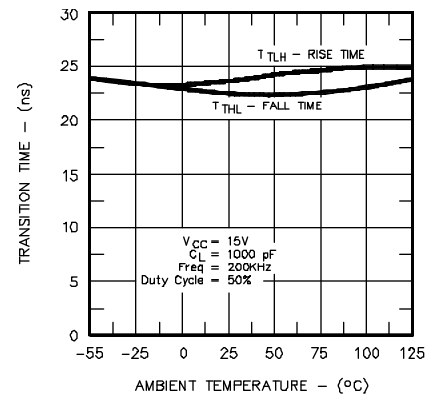

FIGURE 4. TRANSITION TIMES VS. AMBIENT TEMPERATURE

CHARACTERISTIC CURVES (continued)

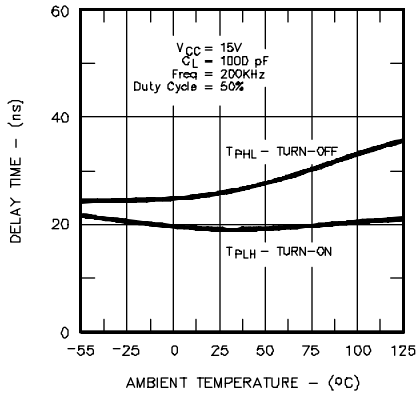

FIGURE 5. PROPAGATION DELAY VS. AMBIENT TEMPERATURE

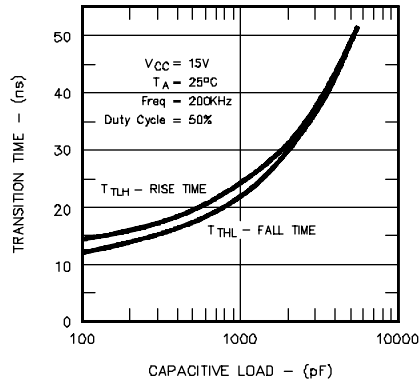

FIGURE 6. TRANSITION TIMES VS. CAPACITIVE LOAD

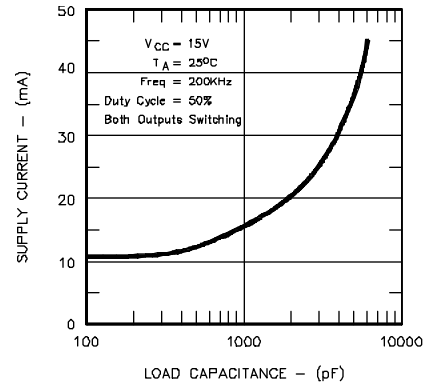

FIGURE 7. SUPPLY CURRENT VS. CAPACITANCE LOAD

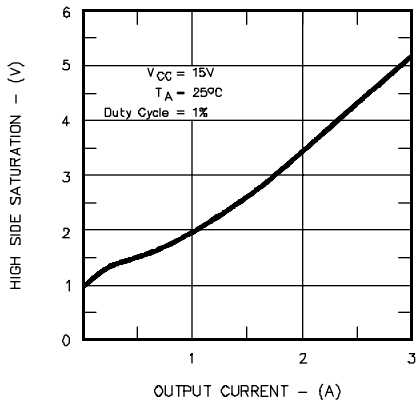

FIGURE 8. HIGH SIDE SATURATION VS. OUTPUT CURRENT

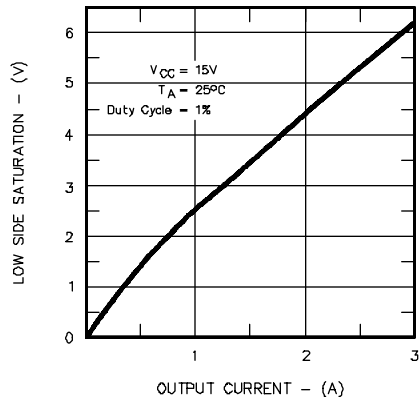

FIGURE 9. LOW SIDE SATURATION VS. OUTPUT CURRENT

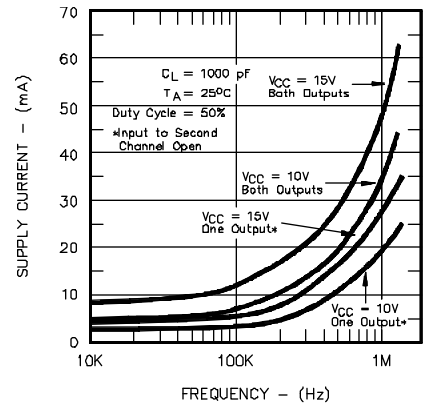

FIGURE 10. SUPPLY CURRENT VS. FREQUENCY

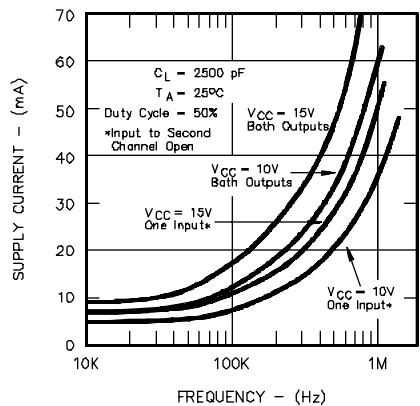

FIGURE 11. SUPPLY CURRENT VS. FREQUENCY

APPLICATION INFORMATION

POWER DISSIPATION

The SG1644, while more energy-efficient than earlier gold-doped driver IC's, can still dissipate considerable power because of its high peak current capability at high frequencies. Total power dissipation in any specific application will be the sum of the DC or steady-state power dissipation, and the AC dissipation caused by driving capacitive loads.

The DC power dissipation is given by:

$$P_{DC} = +V_{CC} \cdot I_{CC} \quad [1]$$

where I_{CC} is a function of the driver state, and hence is duty-cycle dependent.

The AC power dissipation is proportional to the switching frequency, the load capacitance, and the square of the output voltage. In most applications, the driver is constantly changing state, and the AC contribution becomes dominant when the frequency exceeds 100-200KHz.

The SG1644 driver family is available in a variety of packages to accommodate a wide range of operating temperatures and power dissipation requirements. The Absolute Maximums section of the data sheet includes two graphs to aid the designer in choosing an appropriate package for his design.

The designer should first determine the actual power dissipation of the driver by referring to the curves in the data sheet relating operating current to supply voltage, switching frequency, and capacitive load. These curves were generated from data taken on actual devices. The designer can then refer to the Absolute Maximum Thermal Dissipation curves to choose a package type, and to determine if heat-sinking is required.

DESIGN EXAMPLE

Given: Two 250pF loads must be driven push-pull from a +15 volt supply at 100KHz. The application is a commercial one in which the maximum ambient temperature is +50°C, and cost is important.

1. From Figure 11, the average driver current consumption under these conditions will be 18mA, and the power dissipation will be 15volts x 18mA, or 270mW.

2. From the ambient thermal characteristic curve, it can be seen that the M package, which is an 8-pin plastic DIP with a copper lead frame, has more than enough thermal conductance from junction to ambient to support operation at an ambient temperature of +50°C. The SG36446M driver would be specified for this application.

SUPPLY BYPASSING

Since the SG1644 can deliver peak currents above 3amps under some load conditions, adequate supply bypassing is essential for proper operation. Two capacitors in parallel are recommended to guarantee low supply impedance over a wide bandwidth: a 0.1µF ceramic disk capacitor for high frequencies, and a 4.7µF solid

tantalum capacitor for energy storage. In military applications, a CK05 or CK06 ceramic capacitor with a CSR-13 tantalum capacitor is an effective combination. For commercial applications, any low-inductance ceramic disk capacitor teamed with a Sprague 150D or equivalent low ESR capacitor will work well. The capacitors must be located as close as physically possible to the V_{CC} pin, with combined lead and pc board trace lengths held to less than 0.5 inches.

GROUNDING CONSIDERATIONS

The ability of the SG1644 to deliver high peak currents into capacitive loads can cause undesirable negative transients on the logic and power grounds. To avoid this, a low inductance ground path should be considered for each output to return the high peak currents back to its own ground point. A ground plane is recommended for best performance. If space for a ground plane is not available, make the paths as short and as wide as possible. The logic ground can be returned to the supply bypass capacitor and be connected at one point to the power grounds.

LOGIC INTERFACE

The logic input of the 1644 is designed to accept standard DC-coupled 5 volt logic swings, with no speed-up capacitors required. If the input signal voltage exceeds 6 volts, the input pin must be protected against the excessive voltage in the HIGH state. Either a high speed blocking diode must be used, or a resistive divider to attenuate the logic swing is necessary.

LAYOUT FOR HIGH SPEED

The SG1644 can generate relatively large voltage excursions with rise and fall times around 20-30 nanoseconds with light capacitive loads. A Fourier analysis of these time domain signals will indicate strong energy components at frequencies much higher than the basic switching frequency. These high frequencies can induce ringing on an otherwise ideal pulse if sufficient inductance occurs in the signal path (either the positive signal trace or the ground return). Overshoot on the rising edge is undesirable because the excess drive voltage could rupture the gate oxide of a power MOSFET. Trailing edge undershoot is dangerous because the negative voltage excursion can forward-bias the parasitic PN substrate diode of the driver, potentially causing erratic operation or outright failure.

Ringing can be reduced or eliminated by minimizing signal path inductance, and by using a damping resistor between the drive output and the capacitive load. Inductance can be reduced by keeping trace lengths short, trace widths wide, and by using 2oz. copper if possible. The resistor value for critical damping can be calculated from:

$$R_D = 2\sqrt{L/C_L} \quad [2]$$

where L is the total signal line inductance, and C_L is the load capacitance. Values between 10 and 100ohms are usually sufficient. Inexpensive carbon composition resistors are best because they have excellent high frequency characteristics. They should be located as close as possible to the gate terminal of the power MOSFET.

TYPICAL APPLICATIONS

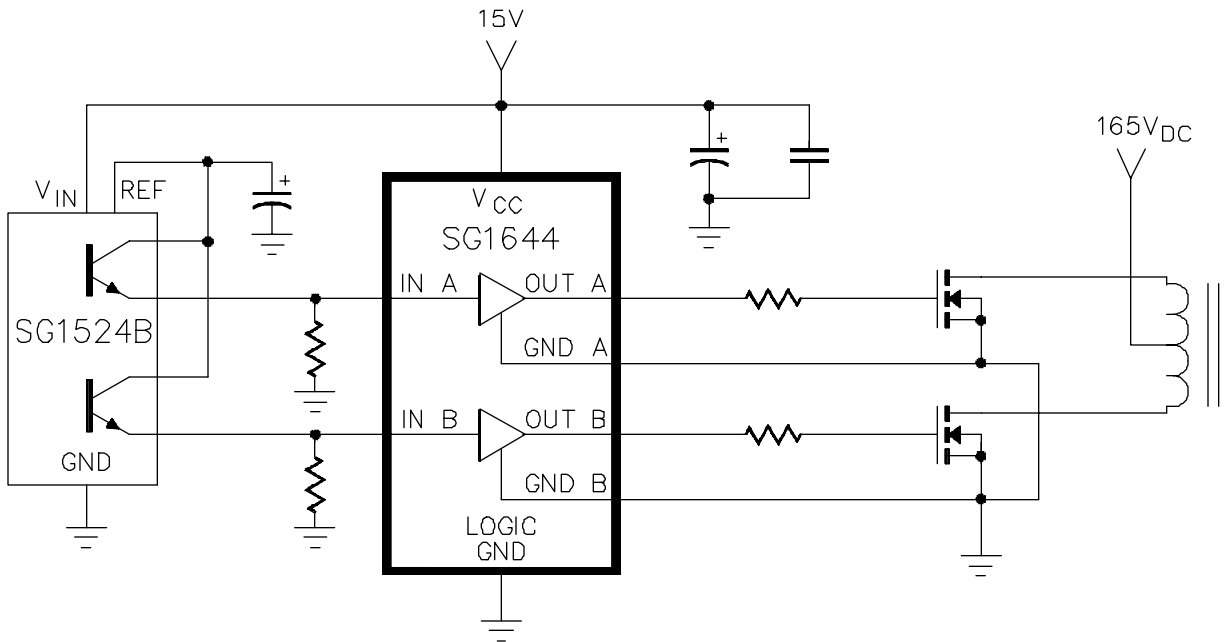

FIGURE 12.

In this push pull converter circuit, the control capabilities of the SG1524B PWM are combined with the powerful totem-pole drivers found in the SG1644 (see SG1626 for example). This inexpensive configuration results in very fast charge and discharge of the power MOSFET gate capacitance for efficient switching.

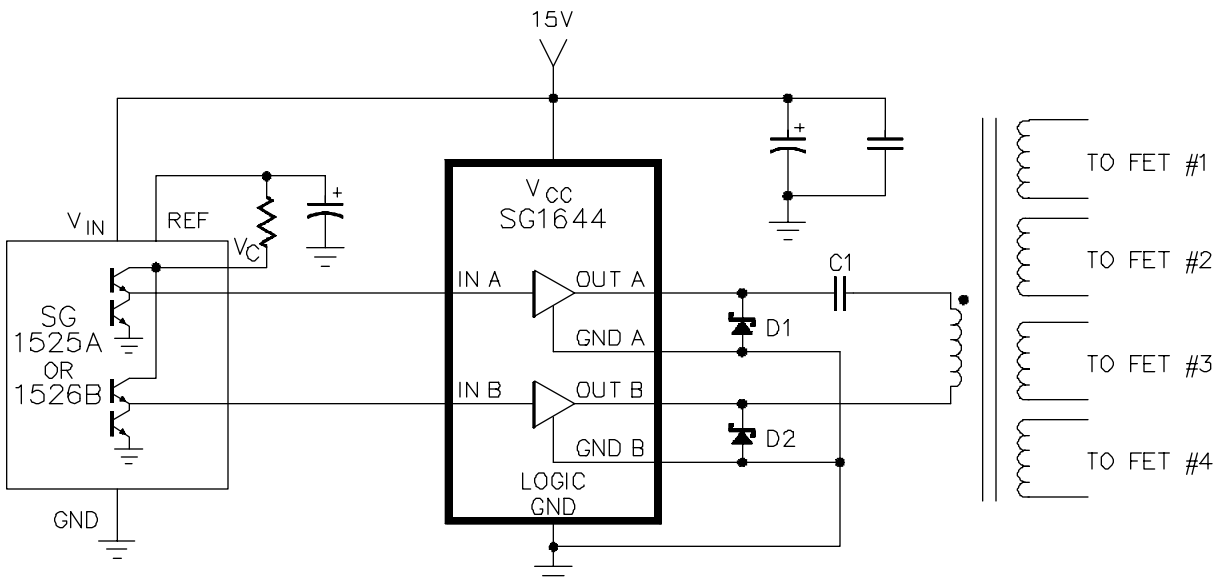

FIGURE 13.

When the peak current capabilities of PWM's such as 1525A or 1526B are not sufficient to drive high capacitive loads fast enough, SG1644 is one solution to this problem. This combination is especially suited for full bridge applications where high input capacitance MOSFETs are being used. Diodes D1 and D2 are necessary if the leakage inductance of the drive transformer will drive the output pins negative.

TYPICAL APPLICATIONS (continued)

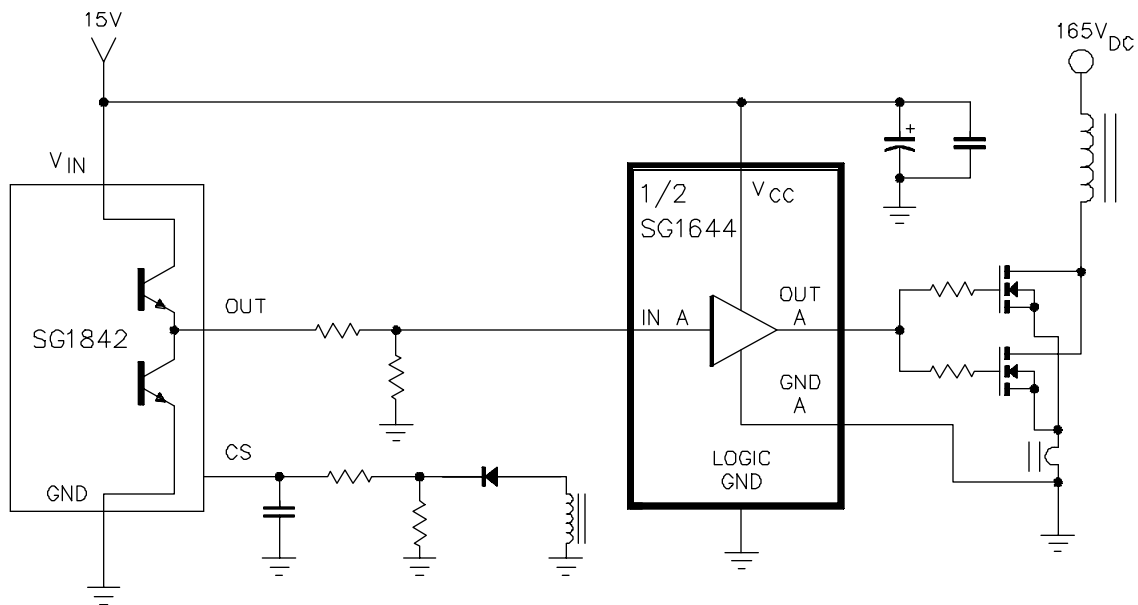

FIGURE 14.

A low cost, yet powerful alternative to the single ended converters with parallel MOSFETs is a combination of SG1842 and SG1644 as shown in Figure 16. This combination will also allow a low noise operation by separating the drive and its associated high peak currents, away from the PWM logic section.

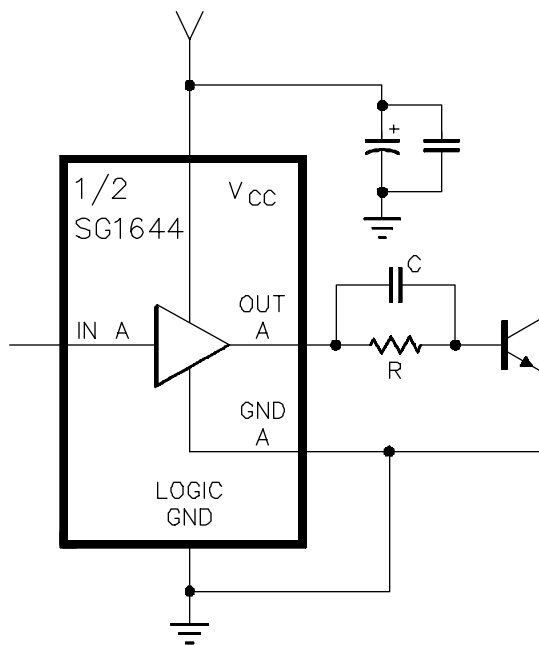

FIGURE 15.

Fast turn off of bipolar transistors is possible by the totem pole output stage of SG1644. The charge on capacitor C will drive the base negative for faster turn off.

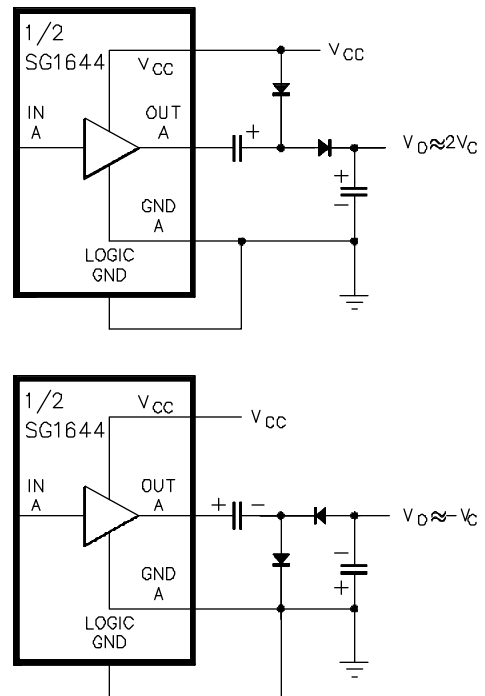

FIGURE 16.

When the inputs are driven with a TTL square wave drive, the high peak current capabilities of SG1644 allow easy implementation of charge pump voltage converters.

CONNECTION DIAGRAMS & ORDERING INFORMATION (See Notes Below)

Package	Part No.	Ambient Temperature Range	Connection Diagram
14-PIN CERAMIC DIP J - PACKAGE	SG1644J/883B SG1644J/DESC SG1644J SG2644J SG3644J	-55°C to 125°C -55°C to 125°C -55°C to 125°C -25°C to 85°C 0°C to 70°C	
8-PIN CERAMIC DIP Y - PACKAGE	SG1644Y/883B SG1644Y/DESC SG1644Y SG2644Y SG3644Y	-55°C to 125°C -55°C to 125°C -55°C to 125°C -25°C to 85°C 0°C to 70°C	<p>M Package: RoHS Compliant / Pb-free Transition DC: 0503 M Package: RoHS / Pb-free 100% Matte Tin Lead Finish</p>
8-PIN PLASTIC DIP M - PACKAGE	SG2644M SG3644M	-25°C to 85°C 0°C to 70°C	
16-PIN WIDE BODY PLASTIC S.O.I.C. DW - PACKAGE	SG2644DW SG3644DW	-25°C to 85°C 0°C to 70°C	<p>DW Package: RoHS Compliant / Pb-free Transition DC: 0516 DW Package: RoHS / Pb-free 100% Matte Tin Lead Finish</p>
8-PIN TO-99 METAL CAN T - PACKAGE	SG1644T/883B SG1644T/DESC SG1644T SG2644T SG3644T	-55°C to 125°C -55°C to 125°C -55°C to 125°C -25°C to 85°C 0°C to 70°C	
9-PIN TO-66 METAL CAN R - PACKAGE	SG1644R/883B SG1644R SG2644R SG3644R	-55°C to 125°C -55°C to 125°C -25°C to 85°C 0°C to 70°C	<p>CASE IS LOGIC GROUND Note: Case and tab are internally connected to substrate ground.</p>
20-PIN CERAMIC (LCC) LEADLESS CHIP CARRIER L- PACKAGE	SG1644L/883B SG1644L/DESC	-55°C to 125°C -55°C to 125°C	<p>(Note 4)</p>

Note 1. Contact factory for JAN and DESC product availability.
2. All packages are viewed from the top.