

LP2985 150-mA, Low-Noise, Low-Dropout Regulator With Shutdown

1 Features

- V_{IN} range (new chip): 2.5 V to 16 V
- V_{OUT} range (new chip):
 - 1.2 V to 5.0 V (fixed, 100-mV steps)
- V_{OUT} accuracy:
 - $\pm 1\%$ for A-grade legacy chip
 - $\pm 1.5\%$ for standard-grade legacy chip
 - $\pm 0.5\%$ for new chip only
- $\pm 1\%$ output accuracy over load, and temperature for new chip
- Output current: Up to 150 mA
- Low I_Q (new chip): 71 μA at $I_{LOAD} = 0$ mA
- Low I_Q (new chip): 750 μA at $I_{LOAD} = 150$ mA
- Shutdown current:
 - 0.01 μA (typ) for legacy chip
 - 1.12 μA (typ) for new chip
- Low noise: 30 μV_{RMS} with 10-nF bypass capacitor
- Output current limiting and thermal protection
- Stable with 2.2- μF ceramic capacitors
- High PSRR: 70 dB at 1 kHz, 40 dB at 1 MHz
- Operating junction temperature: -40°C to $+125^\circ\text{C}$
- Package: 5-pin SOT-23 (DBV)

2 Applications

- [Washer and dryer](#)
- [Land mobile radio](#)
- [Active antenna system mMIMO](#)
- [Cordless power tool](#)
- [Motor drives and control boards](#)

3 Description

The LP2985 is a fixed-output, wide-input, low-noise, low-dropout voltage regulator supporting an input voltage range from 2.5 V to 16 V and up to 150 mA of load current. The LP2985 supports an output range of 1.2 V to 5.0 V (for new chip).

Additionally, the LP2985 (new chip) has a 1% output accuracy across load, and temperature that can meet the needs of low-voltage microcontrollers (MCUs) and processors.

Low output noise of 30 μV_{RMS} (with 10-nF bypass capacitors) and wide bandwidth PSRR performance of greater than 70 dB at 1 kHz and 40 dB at 1 MHz help attenuate the switching frequency of an upstream DC/DC converter and minimize post regulator filtering.

The internal soft-start time and current limit protection reduce inrush current during start up, thus minimizing input capacitance. Standard protection features, such as overcurrent and overtemperature protection, are included.

The LP2985 is available in a 5-pin 2.9-mm \times 1.6-mm SOT-23 (DBV) package.

Package Information

PART NUMBER	PACKAGE ⁽¹⁾	PACKAGING SIZE ⁽²⁾
LP2985	DBV (SOT-23, 5)	2.9 mm \times 2.8 mm

- (1) For all available packages, see the orderable addendum at the end of the data sheet.
- (2) The package size (length \times width) is a nominal value and includes pins, where applicable.

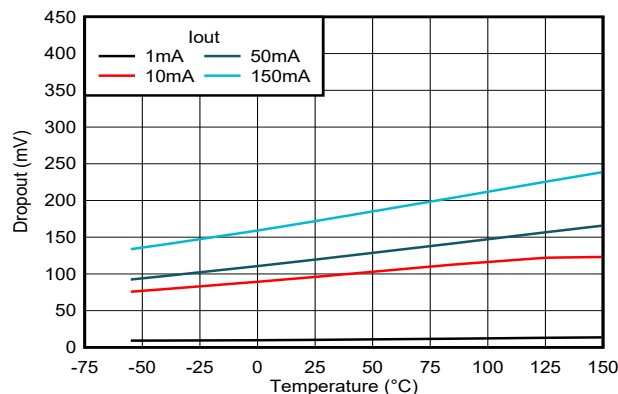

Dropout Voltage vs Temperature for New Chip

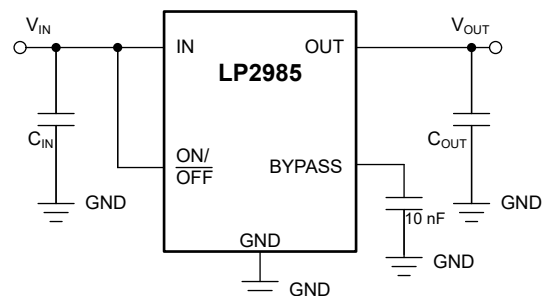

Typical Application Circuit



Table of Contents

1 Features	1	7.4 Device Functional Modes.....	18
2 Applications	1	8 Application and Implementation	20
3 Description	1	8.1 Application Information.....	20
4 Revision History	2	8.2 Typical Application.....	23
5 Pin Configuration and Functions	3	8.3 Power Supply Recommendations.....	28
6 Specifications	4	8.4 Layout.....	28
6.1 Absolute Maximum Ratings.....	4	9 Device and Documentation Support	29
6.2 ESD Ratings.....	4	9.1 Device Nomenclature.....	29
6.3 Recommended Operating Conditions.....	4	9.2 Receiving Notification of Documentation Updates....	29
6.4 Thermal Information.....	5	9.3 Support Resources.....	29
6.5 Electrical Characteristics.....	5	9.4 Trademarks.....	29
6.6 Typical Characteristics.....	9	9.5 Electrostatic Discharge Caution.....	29
7 Detailed Description	16	9.6 Glossary.....	29
7.1 Overview.....	16	10 Mechanical, Packaging, and Orderable Information	29
7.2 Functional Block Diagram.....	16		
7.3 Feature Description.....	16		

4 Revision History

NOTE: Page numbers for previous revisions may differ from page numbers in the current version.

Changes from Revision Q (December 2022) to Revision R (July 2023)	Page
• Widening I _{GND} spec limits to accommodate complete V _{OUT} range.....	5

Changes from Revision P (February 2022) to Revision Q (December 2022)	Page
• Changed <i>Features</i> section.....	1
• Added last bullet to <i>Applications</i> section.....	1
• Changed <i>Description</i> section.....	1
• Changed <i>Description</i> column and added footnote to <i>Pin Functions table</i>	3
• Changed condition statement and curve titles and added curves for new chip in <i>Typical Characteristics</i> section.....	9
• Changed <i>Overview</i> section.....	16
• Changed <i>Functional Block Diagram</i> figure.....	16
• Changed <i>Feature Description</i> section and added subsections.....	16
• Added <i>Output Pulldown</i> section.....	18
• Changed <i>Device Functional Modes</i> section: changed <i>Normal Operation</i> section, added <i>Device Functional Mode Comparison</i> , <i>Dropout Operation</i> , and <i>Disabled</i> sections, and deleted <i>Shutdown Mode</i> section.....	18
• Changed <i>Application Information</i> section: deleted previous information and added new subsections.....	20
• Changed LOW and HIGH pin voltages and deleted slew rate discussion from <i>ON/OFF Operation</i> section....	23
• Changed <i>Application Curves</i> section.....	24
• Changed <i>Layout Diagram</i> figure.....	28
• Added <i>Device Nomenclature</i> section.....	29

5 Pin Configuration and Functions

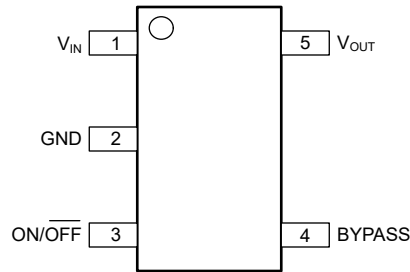

Figure 5-1. DBV Package, 5-Pin SOT-23 (Top View)

Table 5-1. Pin Functions

PIN		TYPE	DESCRIPTION
NAME	NO.		
BYPASS	4	I/O	BYPASS pin to achieve low noise performance. Connecting an external capacitor between BYPASS pin and ground reduces reference voltage noise. See the Recommended Operating Conditions section for more information.
GND	2	—	Ground
ON/OFF	3	I	Enable pin for the LDO. Driving the ON/OFF pin high enables the device. Driving this pin low disables the device. High and low thresholds are listed in the Electrical Characteristics table. Tie this pin to V_{IN} if unused.
V_{IN}	1	I	Input supply pin. Use a capacitor with a value of 1 μF or larger from this pin to ground. See the Input and Output Capacitor Requirements section for more information.
V_{OUT}	5	O	Output of the regulator. Use a capacitor with a value of 2.2 μF or larger from this pin to ground. ⁽¹⁾ See the Input and Output Capacitor Requirements section for more information.

- (1) The nominal output capacitance must be greater than 1 μF . Throughout this document, the nominal derating on these capacitors is 50%. Make sure that the effective capacitance at the pin is greater than 1 μF .

6 Specifications

6.1 Absolute Maximum Ratings

over operating free-air temperature range (unless otherwise noted)^{(1) (2)}

		MIN	MAX	UNIT
V _{IN}	Continuous input voltage range (for legacy chip)	-0.3	16	V
	Continuous input voltage range (for new chip)	-0.3	18	
V _{OUT}	Output voltage range (for legacy chip)	-0.3	9	
	Output voltage range (for new chip)	-0.3	V _{IN} + 0.3 or 9 (whichever is smaller)	
V _{BYPASS}	BYPASS pin voltage range (for new chip)	-0.3	3	
V _{ON/OFF}	ON/OFF pin voltage range (for legacy chip)	-0.3	16	
	ON/OFF pin voltage range (for new chip)	-0.3	18	
Current	Maximum output	Internally limited		
Temperature	Operating junction, T _J	-55	150	°C
	Storage, T _{stg}	-65	150	

- (1) Stresses beyond those listed under *Absolute Maximum Ratings* may cause permanent damage to the device. These are stress ratings only, which do not imply functional operation of the device at these or any other conditions beyond those indicated under *Recommended Operating Conditions*. Exposure to absolute-maximum-rated conditions for extended periods may affect device reliability.
- (2) All voltages with respect to GND.

6.2 ESD Ratings

			VALUE (Legacy Chip)	VALUE (New Chip)	UNIT
V _(ESD)	Electrostatic discharge	Human body model (HBM), per ANSI/ESDA/JEDEC JS-001 ⁽¹⁾	±2000	±3000	V
		Charged device model (CDM), per JEDEC specification JESD22-C101 ⁽²⁾	±500	±1000	

- (1) JEDEC document JEP155 states that 2-kV HBM allows safe manufacturing with a standard ESD control process.
- (2) JEDEC document JEP157 states that 500-V CDM allows safe manufacturing with a standard ESD control process.

6.3 Recommended Operating Conditions

		MIN	NOM	MAX	UNIT
V _{IN}	Supply input voltage (for legacy chip)	2.2		16	V
	Supply input voltage (for new chip)	2.5		16	
V _{OUT}	Output voltage (for legacy chip)	1.2		10.0	
	Output voltage (for new chip)	1.2		5.0	
V _{BYPASS}	Bypass voltage		1.2		
V _{ON/OFF}	Enable voltage (for legacy chip)	0		V _{IN}	
	Enable voltage (for new chip)	0		16	
I _{OUT}	Output current	0		150	
C _{IN} ⁽¹⁾	Input capacitor		1		μF
C _{OUT}	Output capacitor (for legacy chip)	2.2	4.7		μF
	Output capacitance (for new chip) ⁽¹⁾	1	2.2	200	
T _J	Operating junction temperature	-40		125	°C

- (1) All capacitor values are assumed to derate to 50% of the nominal capacitor value. Maintain an effective output capacitance of 1 μF minimum for stability.

6.4 Thermal Information

THERMAL METRIC (2) (1)		Legacy Chip	New Chip	UNIT
		DBV (SOT23-5)	DBV (SOT23-5)	
		5 PINS	5 PINS	
$R_{\theta JA}$	Junction-to-ambient thermal resistance	205.4	178.6	°C/W
$R_{\theta JC(top)}$	Junction-to-case (top) thermal resistance	78.8	77.9	°C/W
$R_{\theta JB}$	Junction-to-board thermal resistance	46.7	47.2	°C/W
Ψ_{JT}	Junction-to-top characterization parameter	8.3	15.9	°C/W
Ψ_{JB}	Junction-to-board characterization parameter	46.3	46.9	°C/W

- (1) For more information about traditional and new thermal metrics, see the [Semiconductor and IC Package Thermal Metrics](#) application note.
- (2) Thermal performance results are based on the JEDEC standard of 2s2p PCB configuration. These thermal metric parameters can be further improved by 35-55% based on thermally optimized PCB layout designs. See the analysis of the [Impact of board layout on LDO thermal performance](#) application report.

6.5 Electrical Characteristics

specified at $T_J = 25^\circ\text{C}$, $V_{IN} = V_{OUT(nom)} + 1.0\text{ V}$ or $V_{IN} = 2.5\text{ V}$ (whichever is greater), $I_{OUT} = 1\text{ mA}$, $V_{ON/OFF} = 2\text{ V}$, $C_{IN} = 1.0\text{ }\mu\text{F}$, and $C_{OUT} = 2.2\text{ }\mu\text{F}$ (unless otherwise noted)

PARAMETER		TEST CONDITIONS		MIN	TYP	MAX	UNIT
ΔV_{OUT}	Output voltage tolerance	$I_L = 1\text{ mA}$	Legacy chip (standard grade)	-1.5		1.5	%
			Legacy chip (A grade)	-1.0		1.0	
			New chip	-0.5		0.5	
		$1\text{ mA} \leq I_L \leq 50\text{ mA}$	Legacy chip (standard grade)	-2.5		2.5	
			Legacy chip (A grade)	-1.5		1.5	
			New chip	-0.5		0.5	
		$1\text{ mA} \leq I_L \leq 150\text{ mA}$	Legacy chip (standard grade)	-3.0		3.0	
			Legacy chip (A grade)	-2.5		2.5	
			New chip	-0.5		0.5	
		$1\text{ mA} \leq I_L \leq 50\text{ mA}$, $-40^\circ\text{C} \leq T_J \leq 125^\circ\text{C}$	Legacy chip (standard grade)	-3.5		3.5	
			Legacy chip (A grade)	-2.5		2.5	
			New chip	-1		1	
$1\text{ mA} \leq I_L \leq 150\text{ mA}$, $-40^\circ\text{C} \leq T_J \leq 125^\circ\text{C}$	Legacy chip (standard grade)	-4.0		4.0			
	Legacy chip (A grade)	-3.5		3.5			
	New chip	-1		1			
$\Delta V_{OUT(\Delta V_{IN})}$	Line regulation	$V_{O(NOM)} + 1\text{ V} \leq V_{IN} \leq 16\text{ V}$	Legacy chip	0.007	0.014	%V	
			New chip	0.002	0.014		
		$V_{O(NOM)} + 1\text{ V} \leq V_{IN} \leq 16\text{ V}$, $-40^\circ\text{C} \leq T_J \leq 125^\circ\text{C}$	Legacy chip	0.007	0.032		
			New chip	0.002	0.032		

6.5 Electrical Characteristics (continued)

specified at $T_J = 25^\circ\text{C}$, $V_{IN} = V_{OUT(nom)} + 1.0\text{ V}$ or $V_{IN} = 2.5\text{ V}$ (whichever is greater), $I_{OUT} = 1\text{ mA}$, $V_{ON/OFF} = 2\text{ V}$, $C_{IN} = 1.0\ \mu\text{F}$, and $C_{OUT} = 2.2\ \mu\text{F}$ (unless otherwise noted)

PARAMETER		TEST CONDITIONS		MIN	TYP	MAX	UNIT	
$V_{IN} - V_{OUT}$	Dropout voltage ⁽¹⁾	$I_{OUT} = 0\text{ mA}$	Legacy chip		1	3	mV	
			New chip		1	2.75		
		$I_{OUT} = 0\text{ mA}, -40^\circ\text{C} \leq T_J \leq 125^\circ\text{C}$	Legacy chip			5		
			New chip					3
		$I_{OUT} = 1\text{ mA}$	Legacy chip			7		10
			New chip			11.5		14
		$I_{OUT} = 1\text{ mA}, -40^\circ\text{C} \leq T_J \leq 125^\circ\text{C}$	Legacy chip					15
			New chip					17
		$I_{OUT} = 10\text{ mA}$	Legacy chip			40		60
			New chip			98		115
		$I_{OUT} = 10\text{ mA}, -40^\circ\text{C} \leq T_J \leq 125^\circ\text{C}$	Legacy chip					90
			New chip					148
		$I_{OUT} = 50\text{ mA}$	Legacy chip			120		150
			New chip			120		145
		$I_{OUT} = 50\text{ mA}, -40^\circ\text{C} \leq T_J \leq 125^\circ\text{C}$	Legacy chip					225
			New chip					184
		$I_{OUT} = 150\text{ mA}$	Legacy chip			280		350
			New chip			180		198
$I_{OUT} = 150\text{ mA}, -40^\circ\text{C} \leq T_J \leq 125^\circ\text{C}$	Legacy chip				575			
	New chip				254			

6.5 Electrical Characteristics (continued)

specified at $T_J = 25^\circ\text{C}$, $V_{IN} = V_{OUT(nom)} + 1.0\text{ V}$ or $V_{IN} = 2.5\text{ V}$ (whichever is greater), $I_{OUT} = 1\text{ mA}$, $V_{ON/OFF} = 2\text{ V}$, $C_{IN} = 1.0\text{ }\mu\text{F}$, and $C_{OUT} = 2.2\text{ }\mu\text{F}$ (unless otherwise noted)

PARAMETER		TEST CONDITIONS		MIN	TYP	MAX	UNIT
I_{GND}	GND pin current	$I_{OUT} = 0\text{ mA}$	Legacy chip	65	95	μA	
			New chip	69	95		
		$I_{OUT} = 0\text{ mA}, -40^\circ\text{C} \leq T_J \leq 125^\circ\text{C}$	Legacy chip	125			
			New chip	123			
		$I_{OUT} = 1\text{ mA}$	Legacy chip	75	110		
			New chip	78	110		
		$I_{OUT} = 1\text{ mA}, -40^\circ\text{C} \leq T_J \leq 125^\circ\text{C}$	Legacy chip	170			
			New chip	140			
		$I_{OUT} = 10\text{ mA}$	Legacy chip	120	220		
			New chip	175	210		
		$I_{OUT} = 10\text{ mA}, -40^\circ\text{C} \leq T_J \leq 125^\circ\text{C}$	Legacy chip	400			
			New chip	250			
		$I_{OUT} = 50\text{ mA}$	Legacy chip	350	600		
			New chip	380	440		
		$I_{OUT} = 50\text{ mA}, -40^\circ\text{C} \leq T_J \leq 125^\circ\text{C}$	Legacy chip	900			
			New chip	650			
		$I_{OUT} = 150\text{ mA}$	Legacy chip	850	1200		
			New chip	765	890		
		$I_{OUT} = 150\text{ mA}, -40^\circ\text{C} \leq T_J \leq 125^\circ\text{C}$	Legacy chip	2000			
			New chip	1060			
$V_{ON/OFF} < 0.3\text{ V}, V_{IN} = 16\text{ V}$	Legacy chip	0.01	0.08				
	New chip	1.25	1.75				
$V_{ON/OFF} < 0.15\text{ V}, V_{IN} = 16\text{ V}, -40^\circ\text{C} \leq T_J \leq 85^\circ\text{C}$	Legacy chip	0	1				
	New chip	1.12	2.25				
$V_{ON/OFF} < 0.15\text{ V}, V_{IN} = 16\text{ V}, -40^\circ\text{C} \leq T_J \leq 125^\circ\text{C}$	Legacy chip	0.01	2				
	New chip	1.12	2.75				
V_{UVLO+}	Rising bias supply UVLO	V_{IN} rising, $-40^\circ\text{C} \leq T_J \leq 125^\circ\text{C}$		2.2	2.4	V	
V_{UVLO-}	Falling bias supply UVLO	V_{IN} falling, $-40^\circ\text{C} \leq T_J \leq 125^\circ\text{C}$	New chip	1.9		V	
$V_{UVLO(HYST)}$	UVLO hysteresis	$-40^\circ\text{C} \leq T_J \leq 125^\circ\text{C}$		0.130		V	
$V_{ON/OFF}$	ON/OFF input voltage	Low = Output OFF	Legacy chip	0.55	V		
			New chip	0.72			
		Low = Output OFF, $V_{OUT} + 1 \leq V_{IN} \leq 16\text{ V}, -40^\circ\text{C} \leq T_J \leq 125^\circ\text{C}$	Legacy chip	0.15			
			New chip	0.15			
		High = Output ON	Legacy chip	1.4			
			New chip	0.85			
		High = Output ON, $V_{OUT} + 1 \leq V_{IN} \leq 16\text{ V}, -40^\circ\text{C} \leq T_J \leq 125^\circ\text{C}$	Legacy chip	1.6			
			New chip	1.6			

6.5 Electrical Characteristics (continued)

specified at $T_J = 25^\circ\text{C}$, $V_{IN} = V_{OUT(nom)} + 1.0\text{ V}$ or $V_{IN} = 2.5\text{ V}$ (whichever is greater), $I_{OUT} = 1\text{ mA}$, $V_{ON/OFF} = 2\text{ V}$, $C_{IN} = 1.0\ \mu\text{F}$, and $C_{OUT} = 2.2\ \mu\text{F}$ (unless otherwise noted)

PARAMETER		TEST CONDITIONS	MIN	TYP	MAX	UNIT	
$I_{ON/OFF}$	ON/OFF input current	$V_{ON/OFF} = 0\text{ V}$	Legacy chip	0.01		μA	
			New chip	0.42			
		$V_{ON/OFF} = 0\text{ V}$, $V_{OUT} + 1 \leq V_{IN} \leq 16\text{ V}$, $-40^\circ\text{C} \leq T_J \leq 125^\circ\text{C}$	Legacy chip		-1		
			New chip		-0.9		
		$V_{ON/OFF} = 5\text{ V}$	Legacy chip		5		
			New chip		0.011		
$V_{ON/OFF} = 5\text{ V}$, $V_{OUT} + 1 \leq V_{IN} \leq 16\text{ V}$, $-40^\circ\text{C} \leq T_J \leq 125^\circ\text{C}$	Legacy chip			15			
	New chip			2.20			
$I_{O(PK)}$	Peak output current	$V_{OUT} \geq V_{O(NOM)} - 5\%$ (steady state)	Legacy chip	300	350	mA	
			New chip	300	350		
$I_{O(SC)}$	Short output current	$R_L = 0\ \Omega$ (steady state)	Legacy chip		400	mA	
			New chip		375		
$\Delta V_O/\Delta V_{IN}$	Ripple rejection	$f = 1\text{ kHz}$, $C_{BYPASS} = 10\text{ nF}$, $C_{OUT} = 10\ \mu\text{F}$	Legacy chip		45	dB	
			New chip		78		
V_n	Output noise voltage	Bandwidth = 300 Hz to 50 kHz, $C_{BYPASS} = 10\text{ nF}$, $C_{OUT} = 2.2\ \mu\text{F}$, $V_{OUT} = 3.3\text{ V}$, $I_{LOAD} = 150\text{ mA}$	Legacy chip		30	μVRMS	
			New chip		30		
T_{sd+}	Thermal shutdown threshold	Shutdown, temperature increasing	New chip		170	$^\circ\text{C}$	
T_{sd-}		Reset, temperature decreasing			150		

- (1) Dropout voltage (V_{DO}) is defined as the input-to-output differential at which the output voltage drops 100 mV below the value measured with a 1 V differential. V_{DO} is measured with $V_{IN} = V_{OUT(nom)} - 100\text{ mV}$ for fixed output devices.

6.6 Typical Characteristics

at operating temperature $T_J = 25^\circ\text{C}$, $V_{IN} = V_{OUT(NOM)} + 1.0\text{ V}$ or 2.5 V (whichever is greater), $I_{OUT} = 1\text{ mA}$, $\text{ON}/\overline{\text{OFF}}$ pin tied to V_{IN} , $C_{IN} = 1.0\ \mu\text{F}$, and $C_{OUT} = 4.7\ \mu\text{F}$ (unless otherwise noted)

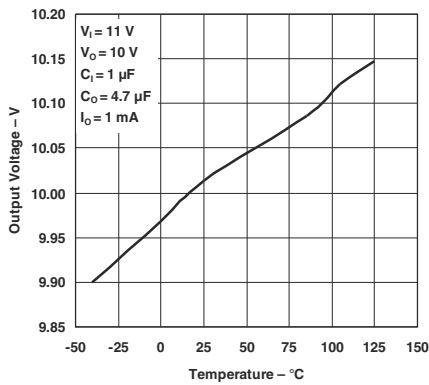

Figure 6-1. Output Voltage vs Temperature for Legacy Chip

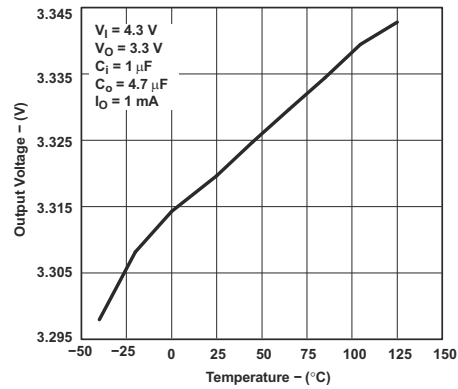

Figure 6-2. Output Voltage vs Temperature for Legacy Chip

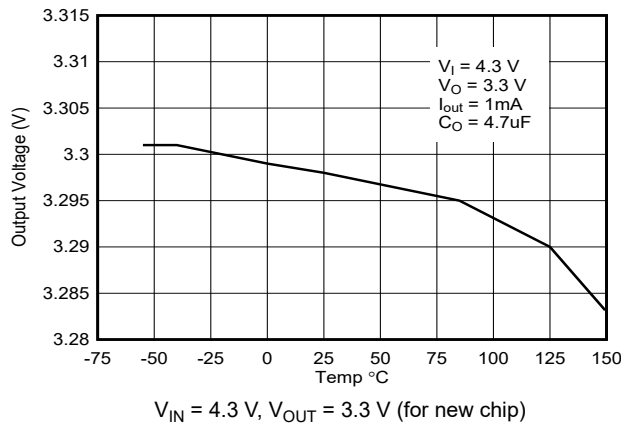

Figure 6-3. Output Voltage vs Temperature for New Chip

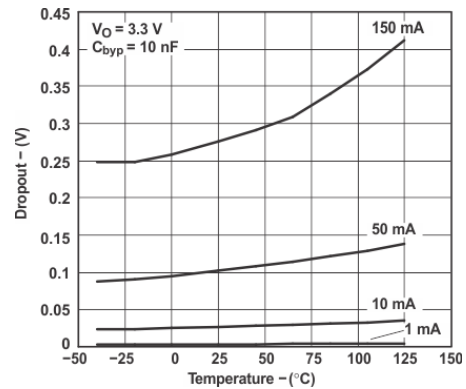

Figure 6-4. Dropout Voltage vs Temperature for Legacy Chip

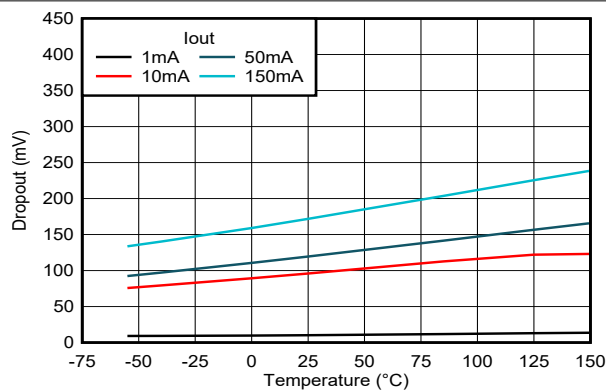

Figure 6-5. Dropout Voltage vs Temperature for New Chip

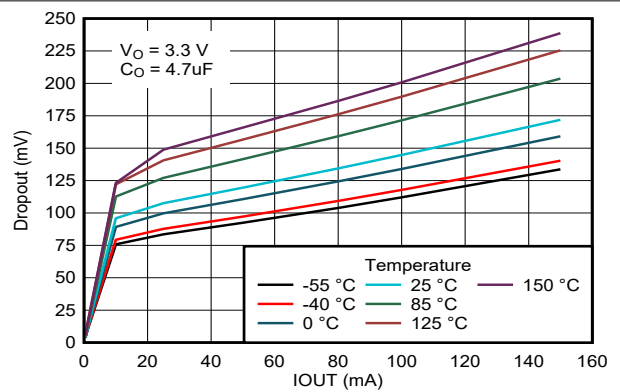

Figure 6-6. Dropout Voltage vs Load Current for New Chip

6.6 Typical Characteristics (continued)

at operating temperature $T_J = 25^\circ\text{C}$, $V_{IN} = V_{OUT(\text{NOM})} + 1.0\text{ V}$ or 2.5 V (whichever is greater), $I_{OUT} = 1\text{ mA}$, ON/OFF pin tied to V_{IN} , $C_{IN} = 1.0\ \mu\text{F}$, and $C_{OUT} = 4.7\ \mu\text{F}$ (unless otherwise noted)

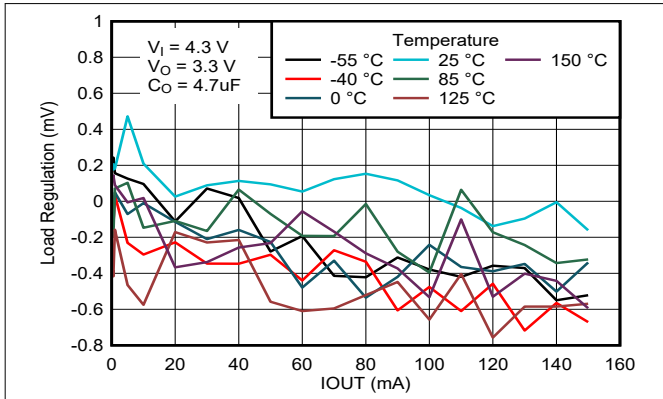

Figure 6-7. Output Regulation vs Load Current for New Chip

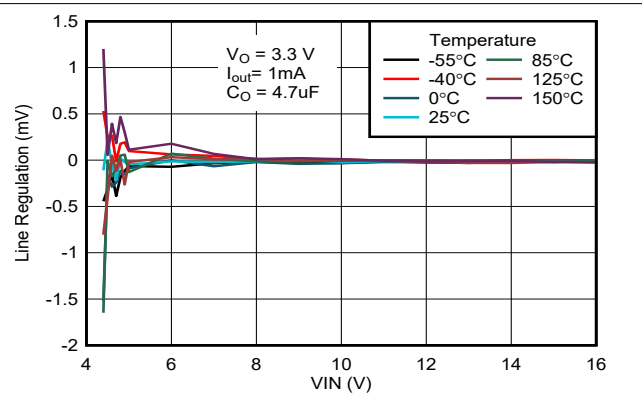

Figure 6-8. Output Regulation vs Input Voltage for New Chip

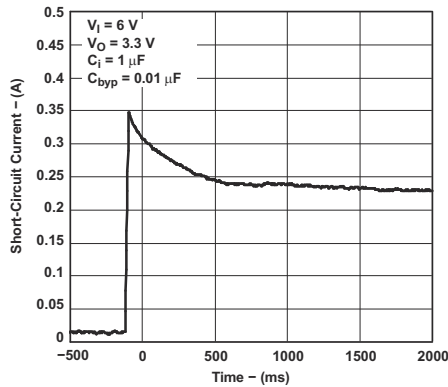

Figure 6-9. Short-Circuit Current vs Time for Legacy Chip

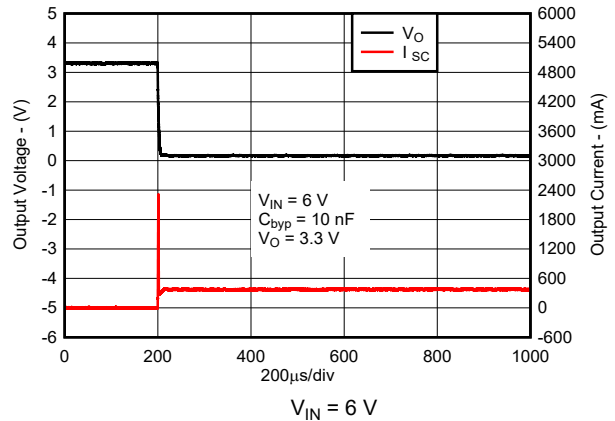

Figure 6-10. Short-Circuit Current vs Time for New Chip

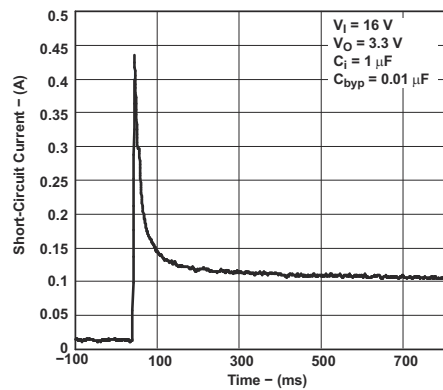

Figure 6-11. Short-Circuit Current vs Time for Legacy Chip

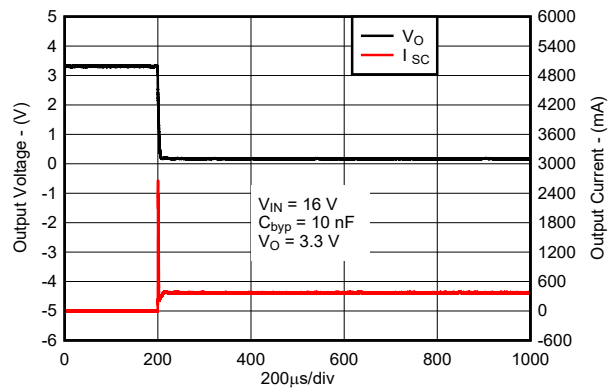

Figure 6-12. Short-Circuit Current vs Time for New Chip

6.6 Typical Characteristics (continued)

at operating temperature $T_J = 25^\circ\text{C}$, $V_{IN} = V_{OUT(\text{NOM})} + 1.0\text{ V}$ or 2.5 V (whichever is greater), $I_{OUT} = 1\text{ mA}$, ON/OFF pin tied to V_{IN} , $C_{IN} = 1.0\ \mu\text{F}$, and $C_{OUT} = 4.7\ \mu\text{F}$ (unless otherwise noted)

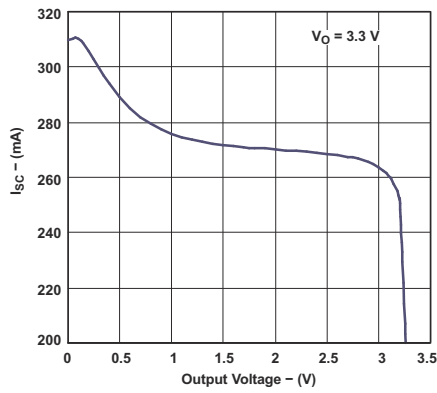

Figure 6-13. Short-Circuit Current vs Output Voltage for Legacy Chip

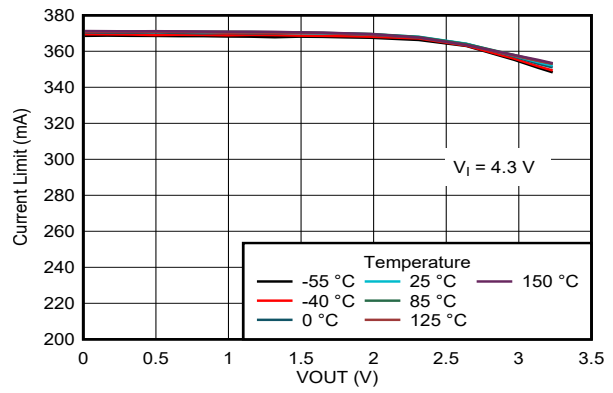

Figure 6-14. Short-Circuit Current vs Output Voltage for New Chip

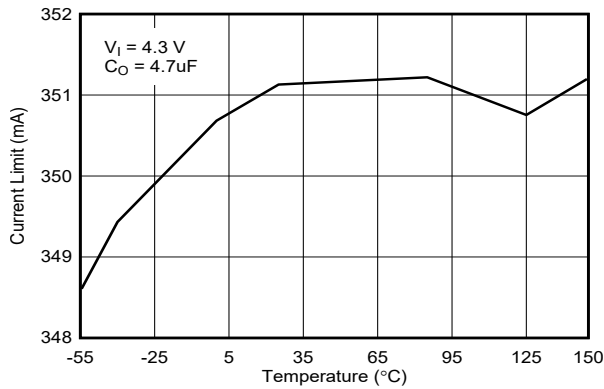

Figure 6-15. Short-Circuit Current vs Temperature for New Chip

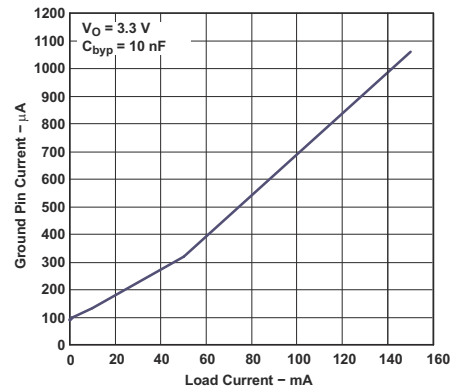

Figure 6-16. Ground Pin Current vs Load Current for Legacy Chip

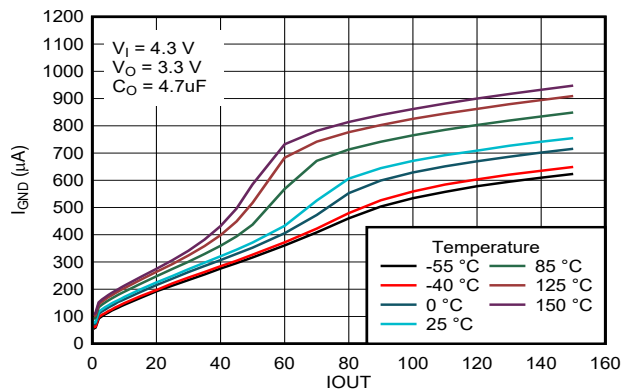

Figure 6-17. Ground Pin Current vs Load Current for New Chip

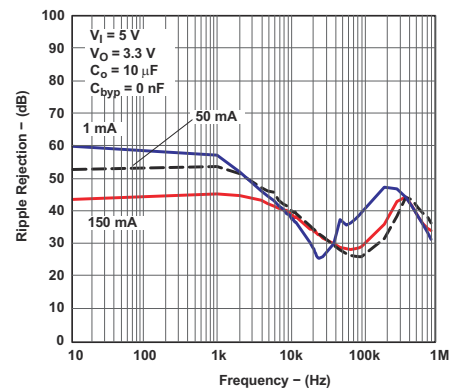
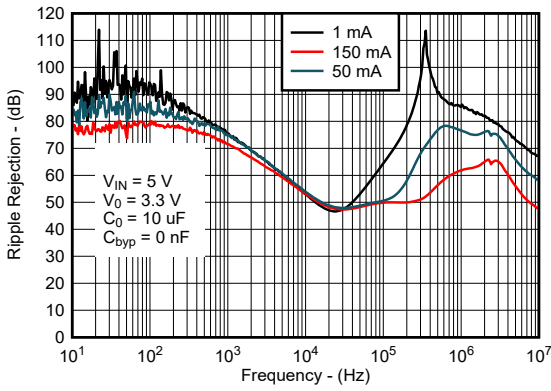

Figure 6-18. Ripple Rejection vs Frequency for Legacy Chip

6.6 Typical Characteristics (continued)

at operating temperature $T_J = 25^\circ\text{C}$, $V_{IN} = V_{OUT(\text{NOM})} + 1.0\text{ V}$ or 2.5 V (whichever is greater), $I_{OUT} = 1\text{ mA}$, ON/OFF pin tied to V_{IN} , $C_{IN} = 1.0\text{ }\mu\text{F}$, and $C_{OUT} = 4.7\text{ }\mu\text{F}$ (unless otherwise noted)



$V_{IN} = 5\text{ V}$, $V_{OUT} = 3.3\text{ V}$, $C_{OUT} = 10\text{ }\mu\text{F}$, $C_{BYP} = 0\text{ nF}$
Figure 6-19. Ripple Rejection vs Frequency for New Chip

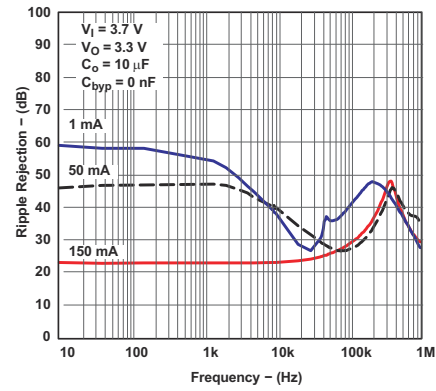
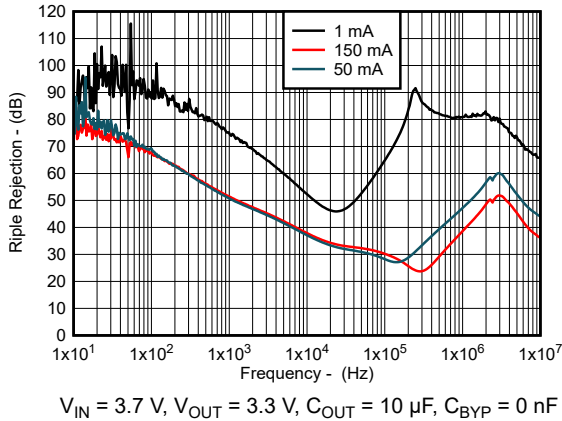

Figure 6-20. Ripple Rejection vs Frequency for Legacy Chip



$V_{IN} = 3.7\text{ V}$, $V_{OUT} = 3.3\text{ V}$, $C_{OUT} = 10\text{ }\mu\text{F}$, $C_{BYP} = 0\text{ nF}$
Figure 6-21. Ripple Rejection vs Frequency for New Chip

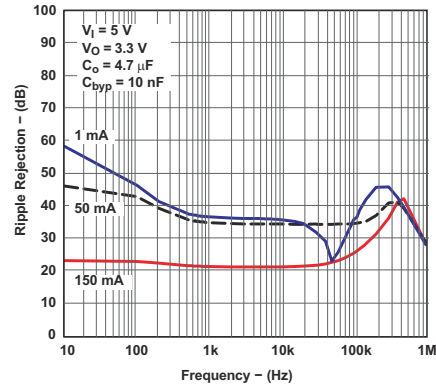
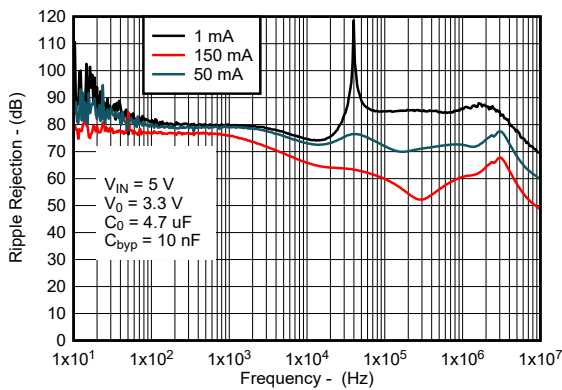
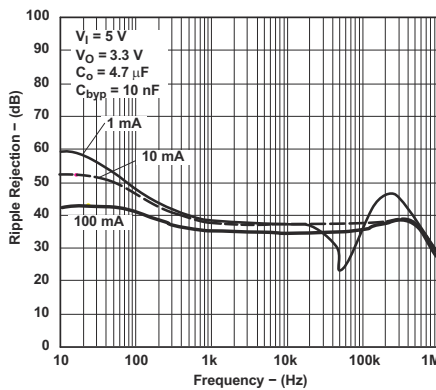

Figure 6-22. Ripple Rejection vs Frequency for Legacy Chip



$V_{IN} = 5\text{ V}$, $V_O = 3.3\text{ V}$, $C_O = 4.7\text{ }\mu\text{F}$, $C_{byp} = 10\text{ nF}$
Figure 6-23. Ripple Rejection vs Frequency for New Chip



$V_I = 5\text{ V}$, $V_O = 3.3\text{ V}$, $C_o = 4.7\text{ }\mu\text{F}$, $C_{byp} = 10\text{ nF}$
Figure 6-24. Ripple Rejection vs Frequency for Legacy Chip

6.6 Typical Characteristics (continued)

at operating temperature $T_J = 25^\circ\text{C}$, $V_{IN} = V_{OUT(NOM)} + 1.0\text{ V}$ or 2.5 V (whichever is greater), $I_{OUT} = 1\text{ mA}$, ON/OFF pin tied to V_{IN} , $C_{IN} = 1.0\text{ }\mu\text{F}$, and $C_{OUT} = 4.7\text{ }\mu\text{F}$ (unless otherwise noted)

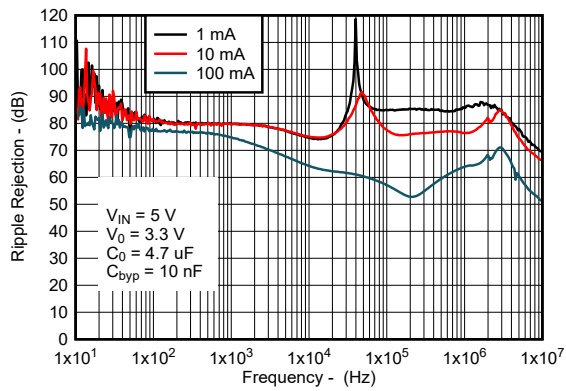

Figure 6-25. Ripple Rejection vs Frequency for New Chip

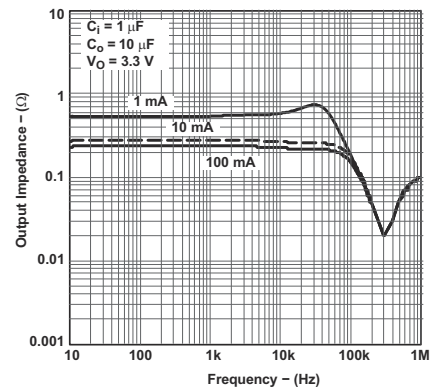

Figure 6-26. Output Impedance vs Frequency for Legacy Chip

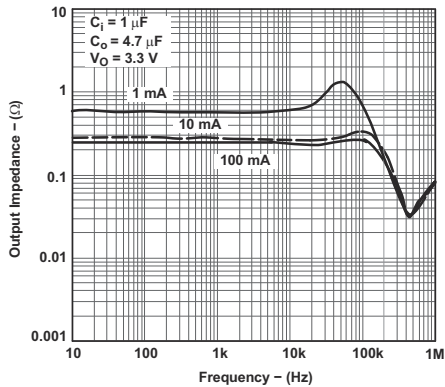

Figure 6-27. Output Impedance vs Frequency for Legacy Chip

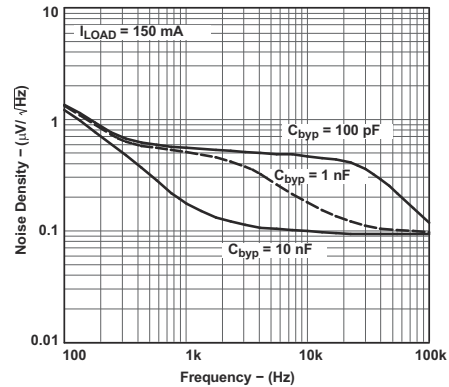

Figure 6-28. Output Noise Density vs Frequency for Legacy Chip

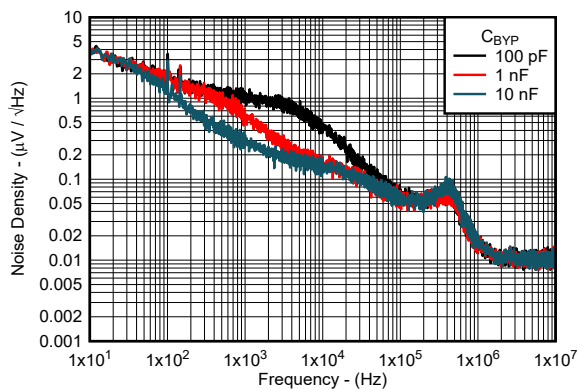

Figure 6-29. Output Noise Density vs Frequency for New Chip

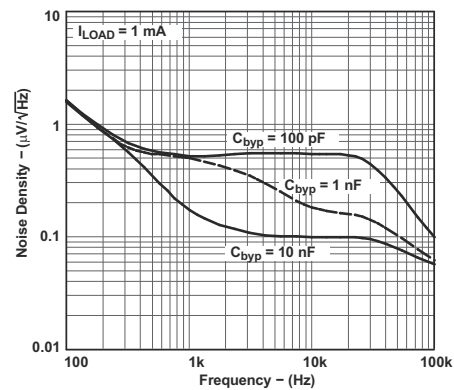

Figure 6-30. Output Noise Density vs Frequency for Legacy Chip

6.6 Typical Characteristics (continued)

at operating temperature $T_J = 25^\circ\text{C}$, $V_{IN} = V_{OUT(NOM)} + 1.0\text{ V}$ or 2.5 V (whichever is greater), $I_{OUT} = 1\text{ mA}$, ON/OFF pin tied to V_{IN} , $C_{IN} = 1.0\ \mu\text{F}$, and $C_{OUT} = 4.7\ \mu\text{F}$ (unless otherwise noted)

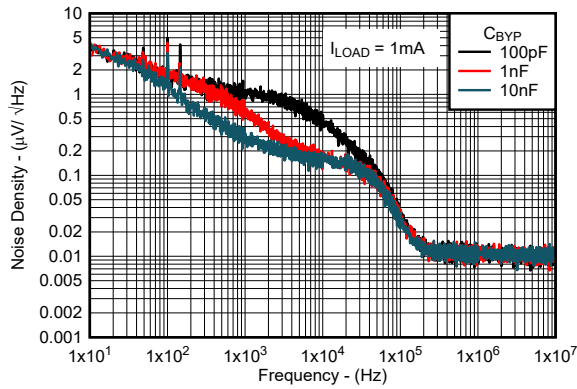

Figure 6-31. Output Noise Density vs Frequency for New Chip

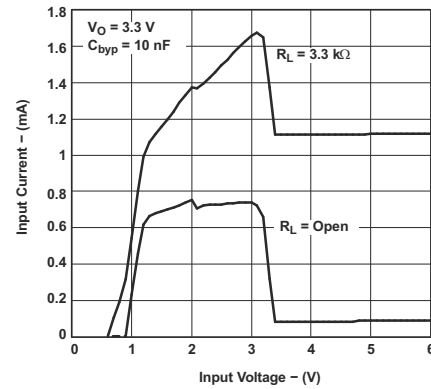

Figure 6-32. Input Current vs Input Voltage for Legacy Chip

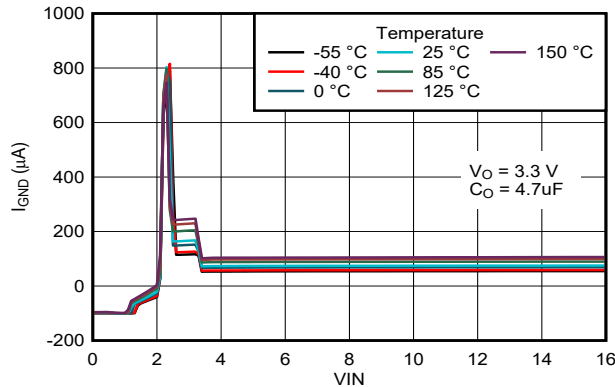

Figure 6-33. Input Current vs Input Voltage for New Chip

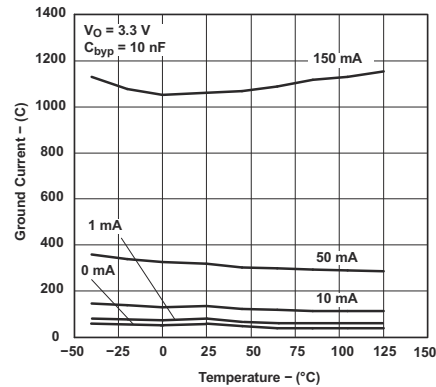

Figure 6-34. Ground-Pin Current vs Temperature for Legacy Chip

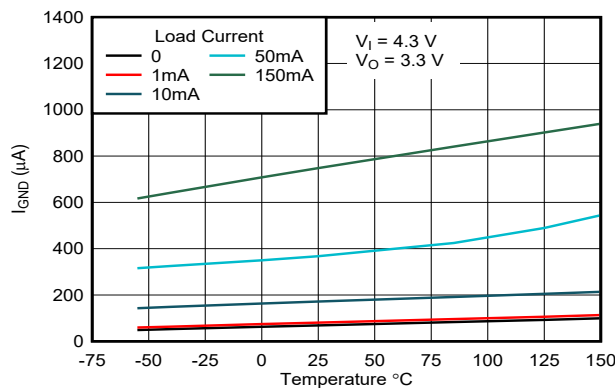

Figure 6-35. Ground-Pin Current vs Temperature for New Chip

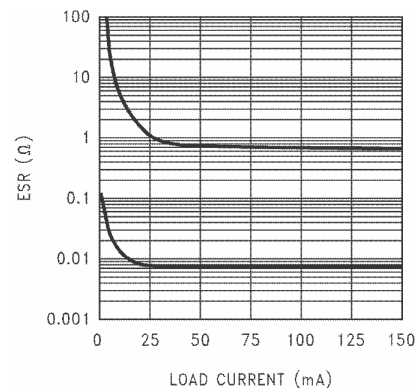

Figure 6-36. 2.2- μF Stable ESR Range for Output Voltage $\leq 2.3\text{ V}$ for Legacy Chip

6.6 Typical Characteristics (continued)

at operating temperature $T_J = 25^\circ\text{C}$, $V_{IN} = V_{OUT(NOM)} + 1.0\text{ V}$ or 2.5 V (whichever is greater), $I_{OUT} = 1\text{ mA}$, $\text{ON}/\overline{\text{OFF}}$ pin tied to V_{IN} , $C_{IN} = 1.0\ \mu\text{F}$, and $C_{OUT} = 4.7\ \mu\text{F}$ (unless otherwise noted)

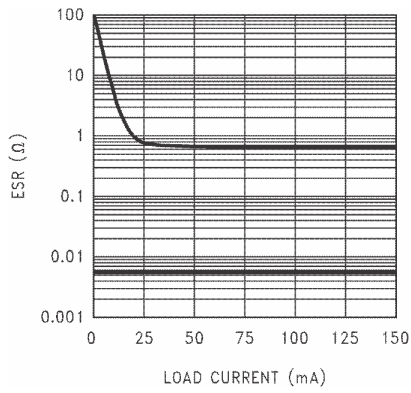

Figure 6-37. 4.7- μF Stable ESR Range for Output Voltage $\leq 2.3\text{ V}$ for Legacy Chip

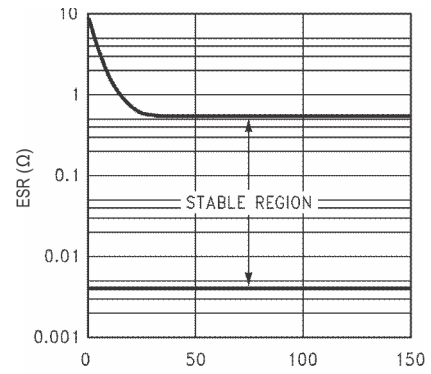

Figure 6-38. 2.2- μF , 3.3- μF Stable ESR Range for Output Voltage $\geq 2.5\text{ V}$ for Legacy Chip

7 Detailed Description

7.1 Overview

The LP2985 is a fixed-output, low-noise, high PSRR, low-dropout regulator that offers exceptional, cost-effective performance for both portable and nonportable applications. The LP2985 has an output tolerance of 1% across line, load, and temperature variation (for the new chip) and is capable of delivering 150 mA of continuous load current.

This device features integrated overcurrent protection, thermal shutdown, output enable, and internal output pulldown and has a built-in soft-start mechanism for controlled inrush current. This device delivers excellent line and load transient performance. The operating ambient temperature range of the device is -40°C to $+125^{\circ}\text{C}$.

7.2 Functional Block Diagram

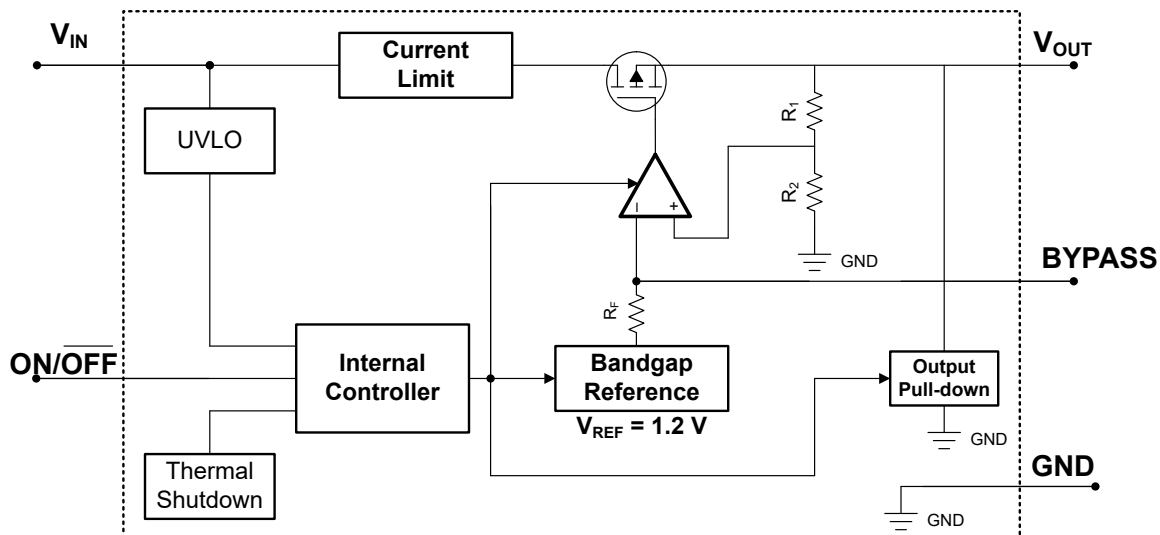

7.3 Feature Description

7.3.1 Output Enable

The $\text{ON}/\overline{\text{OFF}}$ pin for the device is an active-high pin. The output voltage is enabled when the voltage of the $\text{ON}/\overline{\text{OFF}}$ pin is greater than the high-level input voltage of the $\text{ON}/\overline{\text{OFF}}$ pin and disabled with the $\text{ON}/\overline{\text{OFF}}$ pin voltage is less than the low-level input voltage of the $\text{ON}/\overline{\text{OFF}}$ pin. If independent control of the output voltage is not needed, connect the $\text{ON}/\overline{\text{OFF}}$ pin to the input of the device.

The device has an internal pulldown circuit that activates when the device is disabled by pulling the $\text{ON}/\overline{\text{OFF}}$ pin voltage lower than the low-level input voltage of the $\text{ON}/\overline{\text{OFF}}$ pin, to actively discharge the output voltage.

7.3.2 Dropout Voltage

Dropout voltage (V_{DO}) is defined as the input voltage minus the output voltage ($V_{\text{IN}} - V_{\text{OUT}}$) at the rated output current (I_{RATED}), where the pass transistor is fully on. I_{RATED} is the maximum I_{OUT} listed in the [Recommended Operating Conditions](#) table. The pass transistor is in the ohmic or triode region of operation, and acts as a switch. The dropout voltage indirectly specifies a minimum input voltage greater than the nominal programmed output voltage at which the output voltage is expected to stay in regulation. If the input voltage falls to less than the nominal output regulation, then the output voltage falls as well.

For a CMOS regulator, the dropout voltage is determined by the drain-source on-state resistance ($R_{DS(ON)}$) of the pass transistor. Therefore, if the linear regulator operates at less than the rated current, the dropout voltage for that current scales accordingly. The following equation calculates the $R_{DS(ON)}$ of the device.

$$R_{DS(ON)} = \frac{V_{DO}}{I_{RATED}} \quad (1)$$

7.3.3 Current Limit

The device has an internal current limit circuit that protects the regulator during transient high-load current faults or shorting events. The current limit is a brick-wall scheme. In a high-load current fault, the brick-wall scheme limits the output current to the current limit (I_{CL}). I_{CL} is listed in the [Electrical Characteristics](#) table.

The output voltage is not regulated when the device is in current limit. When a current limit event occurs, the device begins to heat up because of the increase in power dissipation. When the device is in brick-wall current limit, the pass transistor dissipates power $[(V_{IN} - V_{OUT}) \times I_{CL}]$. If thermal shutdown is triggered, the device turns off. After the device cools down, the internal thermal shutdown circuit turns the device back on. If the output current fault condition continues, the device cycles between current limit and thermal shutdown. For more information on current limits, see the [Know Your Limits application note](#).

Figure 7-1 shows a diagram of the current limit.

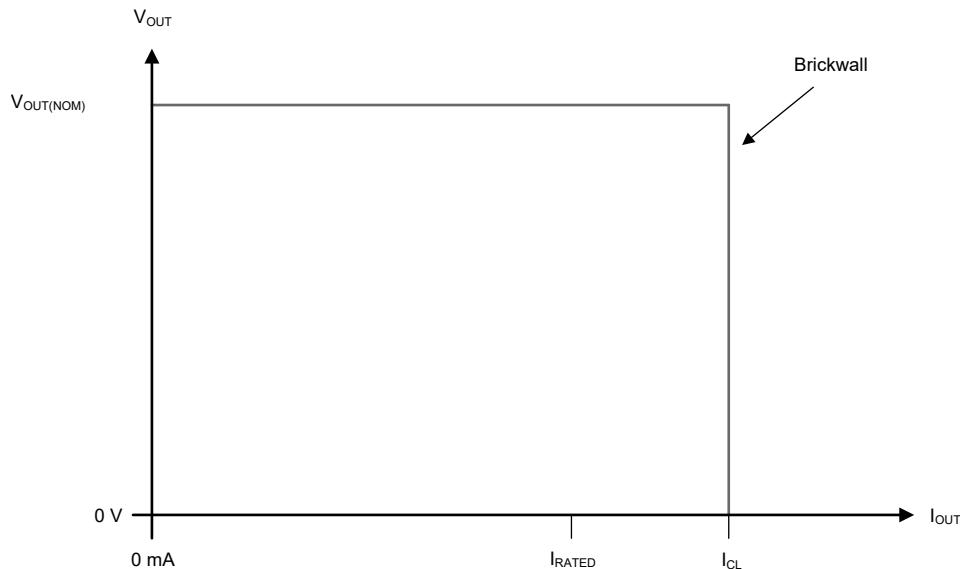

Figure 7-1. Current Limit

7.3.4 Undervoltage Lockout (UVLO)

The device has an independent undervoltage lockout (UVLO) circuit that monitors the input voltage, allowing a controlled and consistent turn on and off of the output voltage. To prevent the device from turning off if the input drops during turn on, the UVLO has hysteresis as specified in the [Electrical Characteristics](#) table.

7.3.5 Output Pulldown

The new chip has an output pulldown circuit. The output pulldown activates in the following conditions:

- When the device is disabled ($V_{ON/OFF} < V_{ON/OFF(LOW)}$)
- If $1.0\text{ V} < V_{IN} < V_{UVLO}$

Do not rely on the output pulldown circuit for discharging a large amount of output capacitance after the input supply has collapsed because reverse current can flow from the output to the input. This reverse current flow can cause damage to the device. See the [Reverse Current](#) section for more details.

7.3.6 Thermal Shutdown

The device contains a thermal shutdown protection circuit to disable the device when the junction temperature (T_J) of the pass transistor rises to $T_{SD(shutdown)}$ (typical). Thermal shutdown hysteresis assures that the device resets (turns on) when the temperature falls to $T_{SD(reset)}$ (typical).

The thermal time-constant of the semiconductor die is fairly short, thus the device can cycle on and off when thermal shutdown is reached until power dissipation is reduced. Power dissipation during start up can be high from large $V_{IN} - V_{OUT}$ voltage drops across the device or from high inrush currents charging large output capacitors. Under some conditions, the thermal shutdown protection disables the device before start up completes.

For reliable operation, limit the junction temperature to the maximum listed in the [Recommended Operating Conditions](#) table. Operation above this maximum temperature causes the device to exceed operational specifications. Although the internal protection circuitry of the device is designed to protect against thermal overall conditions, this circuitry is not intended to replace proper heat sinking. Continuously running the device into thermal shutdown or above the maximum recommended junction temperature reduces long-term reliability.

7.4 Device Functional Modes

7.4.1 Device Functional Mode Comparison

Table 7-1 shows the conditions that lead to the different modes of operation. See the [Electrical Characteristics](#) table for parameter values.

Table 7-1. Device Functional Mode Comparison

OPERATING MODE	PARAMETER			
	V_{IN}	$V_{ON/OFF}$	I_{OUT}	T_J
Normal operation	$V_{IN} > V_{OUT(nom)} + V_{DO}$ and $V_{IN} > V_{IN(min)}$	$V_{ON/OFF} > V_{ON/OFF(HI)}$	$I_{OUT} < I_{OUT(max)}$	$T_J < T_{SD(shutdown)}$
Dropout operation	$V_{IN(min)} < V_{IN} < V_{OUT(nom)} + V_{DO}$	$V_{ON/OFF} > V_{ON/OFF(HI)}$	$I_{OUT} < I_{OUT(max)}$	$T_J < T_{SD(shutdown)}$
Disabled (any true condition disables the device)	$V_{IN} < V_{UVLO}$	$V_{ON/OFF} < V_{ON/OFF(LOW)}$	Not applicable	$T_J > T_{SD(shutdown)}$

7.4.2 Normal Operation

The device regulates to the nominal output voltage when the following conditions are met:

- The input voltage is greater than the nominal output voltage plus the dropout voltage ($V_{OUT(nom)} + V_{DO}$)
- The output current is less than the current limit ($I_{OUT} < I_{CL}$)
- The device junction temperature is less than the thermal shutdown temperature ($T_J < T_{SD}$)
- The ON/OFF voltage has previously exceeded the ON/OFF rising threshold voltage and has not yet decreased to less than the enable falling threshold

7.4.3 Dropout Operation

If the input voltage is lower than the nominal output voltage plus the specified dropout voltage, but all other conditions are met for normal operation, the device operates in dropout mode. In this mode, the output voltage tracks the input voltage. During this mode, the transient performance of the device becomes significantly degraded because the pass transistor is in the ohmic or triode region, and acts as a switch. Line or load transients in dropout can result in large output-voltage deviations.

When the device is in a steady dropout state (defined as when the device is in dropout, $V_{IN} < V_{OUT(NOM)} + V_{DO}$, directly after being in a normal regulation state, but *not* during start up), the pass transistor is driven into the ohmic or triode region. When the input voltage returns to a value greater than or equal to the nominal output voltage plus the dropout voltage ($V_{OUT(NOM)} + V_{DO}$), the output voltage can overshoot for a short period of time while the device pulls the pass transistor back into the linear region.

7.4.4 Disabled

The output of the device can be shutdown by forcing the voltage of the ON/OFF pin to less than the maximum ON/OFF pin low-level input voltage (see the [Electrical Characteristics](#) table). When disabled, the pass transistor is turned off, internal circuits are shutdown, and the output voltage is actively discharged to ground by an internal discharge circuit from the output to ground.

8 Application and Implementation

Note

Information in the following applications sections is not part of the TI component specification, and TI does not warrant its accuracy or completeness. TI's customers are responsible for determining suitability of components for their purposes, as well as validating and testing their design implementation to confirm system functionality.

8.1 Application Information

8.1.1 Recommended Capacitor Types

The device is designed to be stable using low equivalent series resistance (ESR) ceramic capacitors at the input and output. Multilayer ceramic capacitors have become the industry standard for these types of applications and are recommended, but must be used with good judgment. Ceramic capacitors that employ X7R-, X5R-, and C0G-rated dielectric materials provide relatively good capacitive stability across temperature, whereas the use of Y5V-rated capacitors is discouraged because of large variations in capacitance.

Regardless of the ceramic capacitor type selected, the effective capacitance varies with operating voltage and temperature. Generally, expect the effective capacitance to decrease by as much as 50%. The input and output capacitors listed in the [Recommended Operating Conditions](#) table account for an effective capacitance of approximately 50% of the nominal value.

8.1.2 Input and Output Capacitor Requirements

Although an input capacitor is not required for stability, good analog design practice is to connect a capacitor from IN to GND. This capacitor counteracts reactive input sources and improves transient response, input ripple, and PSRR. Use an input capacitor if the source impedance is more than 0.5 Ω . A higher value capacitor can be necessary if large, fast rise-time load or line transients are anticipated or if the device is located several inches from the input power source.

Dynamic performance of the device is improved with the use of an output capacitor. Use an output capacitor within the range specified in the [Recommended Operating Conditions](#) table for stability.

8.1.3 Noise Bypass Capacitor (C_{BYPASS})

The LP2985 allows for low-noise performance with the use of a bypass capacitor that is connected to the internal band-gap reference with the BYPASS pin. This high-impedance band-gap circuitry is biased in the microampere range and, thus, cannot be loaded significantly, otherwise, the output (and, correspondingly, the output of the regulator) changes. Thus, for best output accuracy, dc leakage current through C_{BYPASS} must be minimized as much as possible and must never exceed 100 nA. The C_{BYPASS} capacitor also impacts the start-up behavior of the regulator. Inrush current and start-up time increase with larger bypass capacitor values.

Use a 10-nF capacitor for C_{BYPASS} . Ceramic and film capacitors are good choices for this purpose.

8.1.4 Reverse Current

Excessive reverse current can damage this device. Reverse current flows through the intrinsic body diode of the pass transistor instead of the normal conducting channel. At high magnitudes, this current flow degrades the long-term reliability of the device.

Conditions where reverse current can occur are outlined in this section, all of which can exceed the absolute maximum rating of $V_{\text{OUT}} \leq V_{\text{IN}} + 0.3 \text{ V}$.

- If the device has a large C_{OUT} and the input supply collapses with little or no load current
- The output is biased when the input supply is not established
- The output is biased above the input supply

If reverse current flow is expected in the application, use external protection to protect the device. Reverse current is not limited in the device, so external limiting is required if extended reverse voltage operation is anticipated.

Figure 8-1 shows one approach for protecting the device.

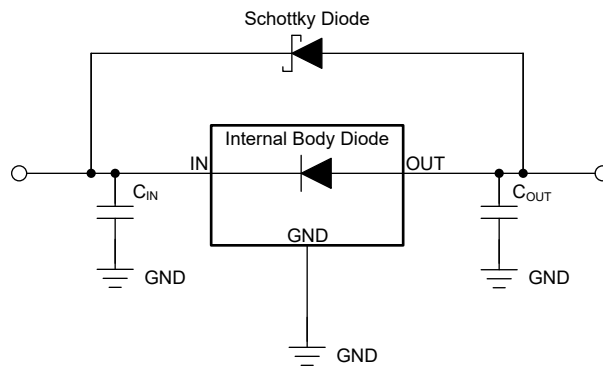

Figure 8-1. Example Circuit for Reverse Current Protection Using a Schottky Diode

8.1.5 Power Dissipation (P_D)

Circuit reliability requires consideration of the device power dissipation, location of the circuit on the printed circuit board (PCB), and correct sizing of the thermal plane. The PCB area around the regulator must have few or no other heat-generating devices that cause added thermal stress.

To first-order approximation, power dissipation in the regulator depends on the input-to-output voltage difference and load conditions. The following equation calculates power dissipation (P_D).

$$P_D = (V_{IN} - V_{OUT}) \times I_{OUT} \quad (2)$$

Note

Power dissipation can be minimized, and therefore greater efficiency can be achieved, by correct selection of the system voltage rails. For the lowest power dissipation use the minimum input voltage required for correct output regulation.

For devices with a thermal pad, the primary heat conduction path for the device package is through the thermal pad to the PCB. Solder the thermal pad to a copper pad area under the device. This pad area must contain an array of plated vias that conduct heat to additional copper planes for increased heat dissipation.

The maximum power dissipation determines the maximum allowable ambient temperature (T_A) for the device. According to the following equation, power dissipation and junction temperature are most often related by the junction-to-ambient thermal resistance ($R_{\theta JA}$) of the combined PCB and device package and the temperature of the ambient air (T_A).

$$T_J = T_A + (R_{\theta JA} \times P_D) \quad (3)$$

Thermal resistance ($R_{\theta JA}$) is highly dependent on the heat-spreading capability built into the particular PCB design, and therefore varies according to the total copper area, copper weight, and location of the planes. The junction-to-ambient thermal resistance listed in the [Thermal Information](#) table is determined by the JEDEC standard PCB and copper-spreading area, and is used as a relative measure of package thermal performance.

8.1.6 Estimating Junction Temperature

The JEDEC standard now recommends the use of psi (Ψ) thermal metrics to estimate the junction temperatures of the linear regulator when in-circuit on a typical PCB board application. These metrics are not thermal resistance parameters and instead offer a practical and relative way to estimate junction temperature. These psi metrics are determined to be significantly independent of the copper area available for heat-spreading. The [Thermal Information](#) table lists the primary thermal metrics, which are the junction-to-top characterization parameter (ψ_{JT}) and junction-to-board characterization parameter (ψ_{JB}). These parameters provide two methods for calculating the junction temperature (T_J), as described in the following equations. Use the junction-to-top characterization parameter (ψ_{JT}) with the temperature at the center-top of device package (T_T) to calculate

the junction temperature. Use the junction-to-board characterization parameter (ψ_{JB}) with the PCB surface temperature 1 mm from the device package (T_B) to calculate the junction temperature.

$$T_J = T_T + \psi_{JT} \times P_D \quad (4)$$

where:

- P_D is the dissipated power
- T_T is the temperature at the center-top of the device package

$$T_J = T_B + \psi_{JB} \times P_D \quad (5)$$

where:

- T_B is the PCB surface temperature measured 1 mm from the device package and centered on the package edge

For detailed information on the thermal metrics and how to use them, see the [Semiconductor and IC Package Thermal Metrics application note](#).

8.2 Typical Application

Figure 8-2 shows the standard usage of the LP2985 as a low-dropout regulator.

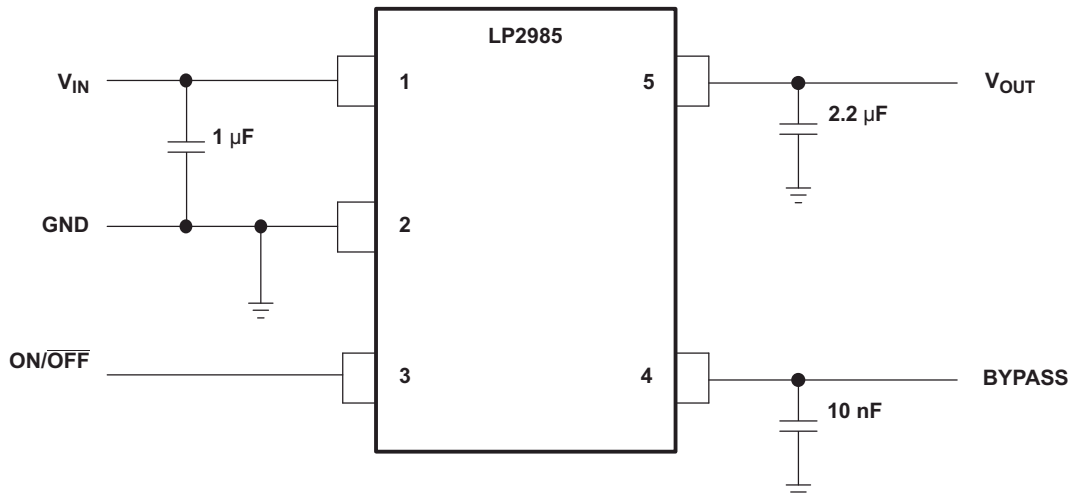

Figure 8-2. LP2985 Typical Application

8.2.1 Design Requirements

Minimum C_{OUT} value for stability (can be increased without limit for improved stability and transient response)

ON/\overline{OFF} must be actively terminated. Connect to V_{IN} if shutdown feature is not used.

Optional BYPASS capacitor for low-noise operation.

8.2.2 Detailed Design Procedure

8.2.2.1 ON/\overline{OFF} Operation

The LP2985 allows for a shutdown mode via the ON/\overline{OFF} pin. Driving the pin LOW (≤ 0.4 V) turns the device OFF; conversely, a HIGH (≥ 1.2 V) turns the device ON. If the shutdown feature is not used, connect ON/\overline{OFF} to the input to ensure that the regulator is on at all times. For proper operation, do not leave ON/\overline{OFF} unconnected.

8.2.3 Application Curves

at operating temperature $T_J = 25^\circ\text{C}$, $V_{IN} = V_{OUT(NOM)} + 1.0\text{ V}$ or 2.5 V (whichever is greater), $I_{OUT} = 1\text{ mA}$, ON/OFF pin tied to V_{IN} , $C_{IN} = 1.0\text{ }\mu\text{F}$, and $C_{OUT} = 4.7\text{ }\mu\text{F}$ (unless otherwise noted)

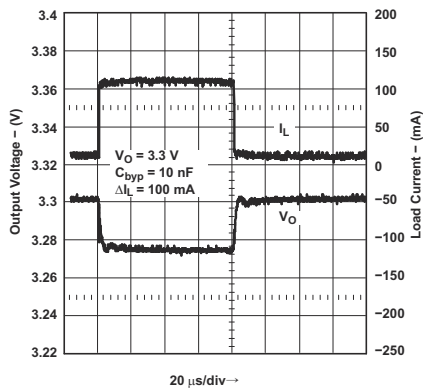

Figure 8-3. Load Transient Response for Legacy Chip

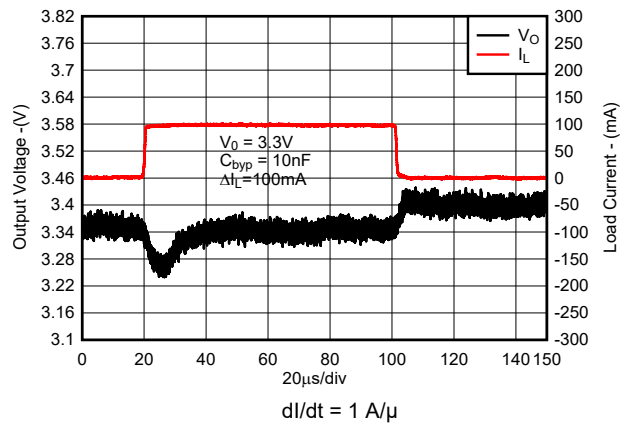

Figure 8-4. Load Transient Response for New Chip

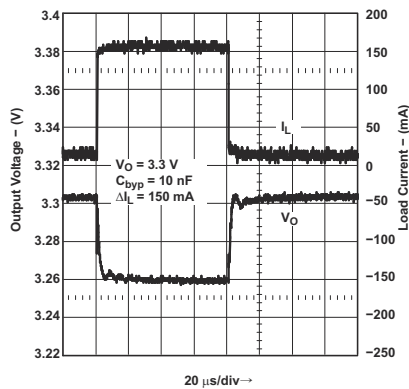

Figure 8-5. Load Transient Response for Legacy Chip

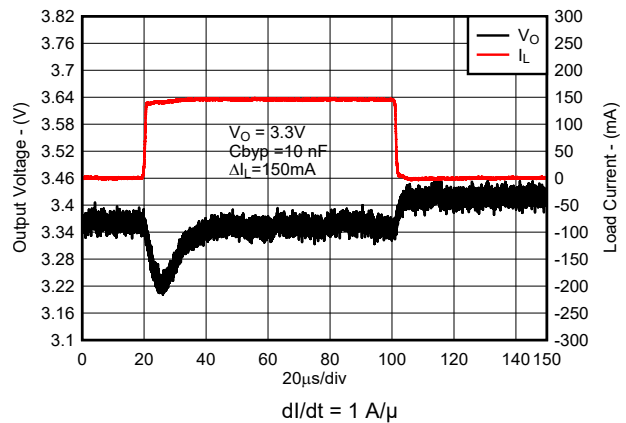

Figure 8-6. Load Transient for New Chip

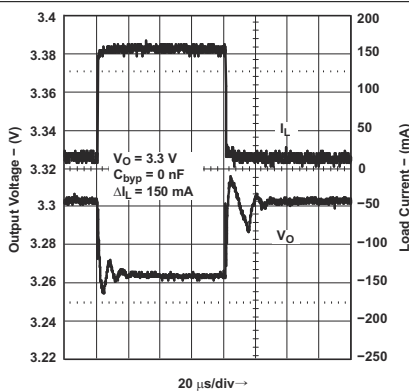

Figure 8-7. Load Transient Response for Legacy Chip

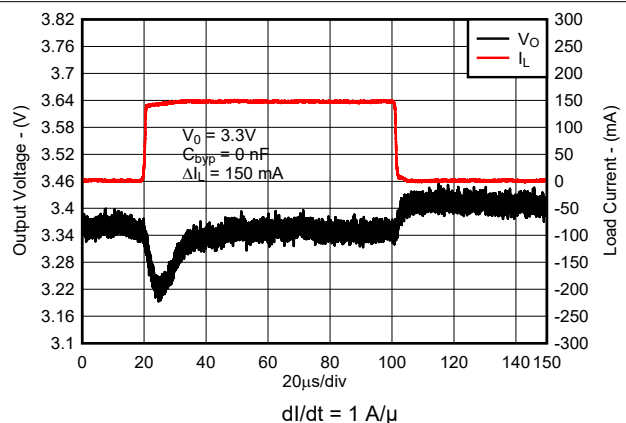

Figure 8-8. Load Transient Response for New Chip

8.2.3 Application Curves (continued)

at operating temperature $T_J = 25^\circ\text{C}$, $V_{IN} = V_{OUT(NOM)} + 1.0\text{ V}$ or 2.5 V (whichever is greater), $I_{OUT} = 1\text{ mA}$, ON/OFF pin tied to V_{IN} , $C_{IN} = 1.0\text{ }\mu\text{F}$, and $C_{OUT} = 4.7\text{ }\mu\text{F}$ (unless otherwise noted)

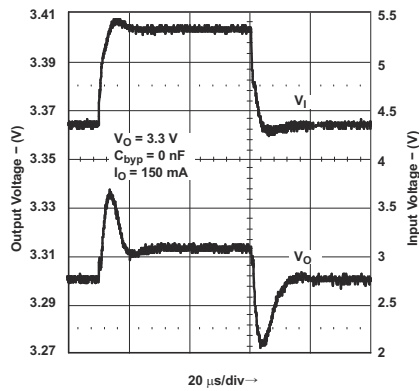

Figure 8-9. Line Transient Response for Legacy Chip

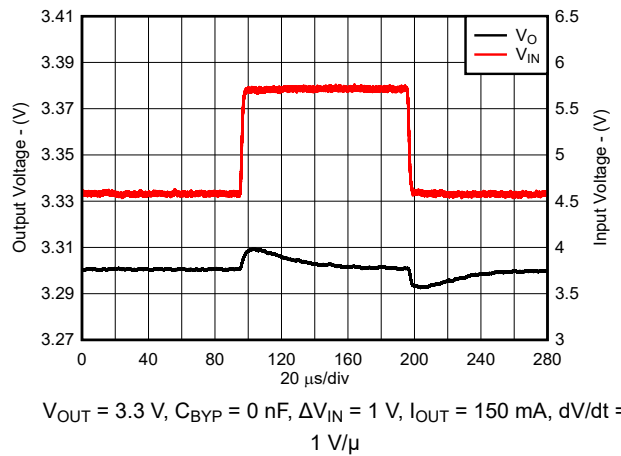

Figure 8-10. Line Transient Response for New Chip

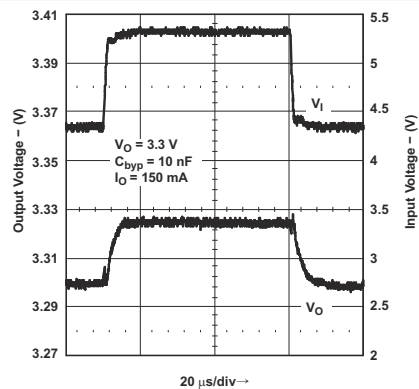

Figure 8-11. Line Transient Response for Legacy Chip

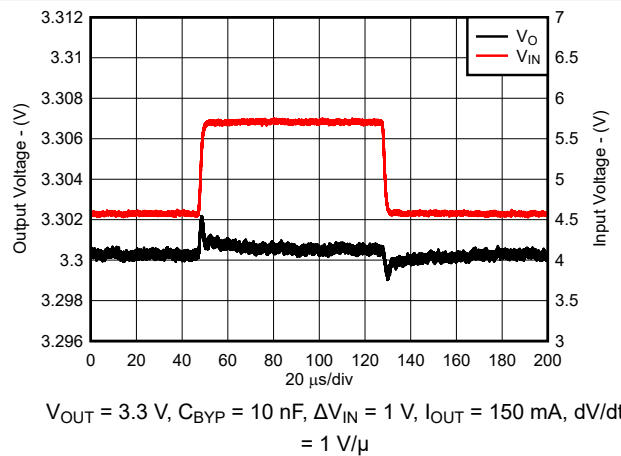

Figure 8-12. Line Transient Response for New Chip

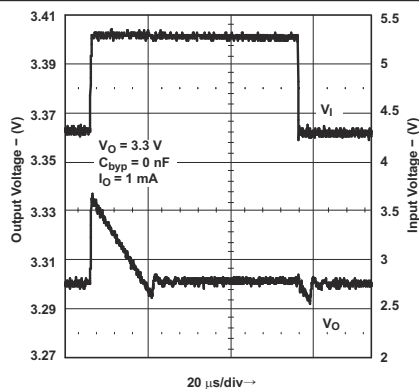

Figure 8-13. Line Transient Response for Legacy Chip

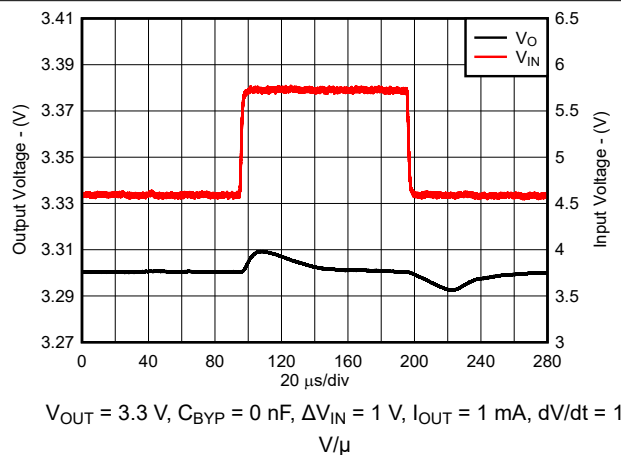

Figure 8-14. Line Transient Response for New Chip

8.2.3 Application Curves (continued)

at operating temperature $T_J = 25^\circ\text{C}$, $V_{IN} = V_{OUT(NOM)} + 1.0\text{ V}$ or 2.5 V (whichever is greater), $I_{OUT} = 1\text{ mA}$, ON/OFF pin tied to V_{IN} , $C_{IN} = 1.0\text{ }\mu\text{F}$, and $C_{OUT} = 4.7\text{ }\mu\text{F}$ (unless otherwise noted)

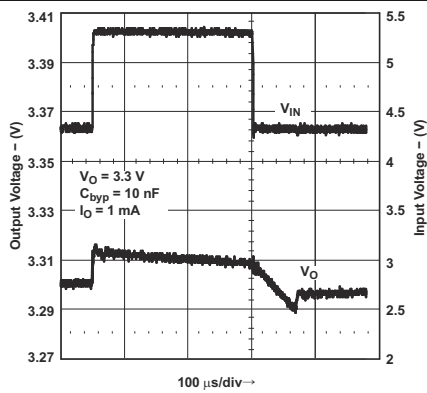

Figure 8-15. Line Transient Response for Legacy Chip

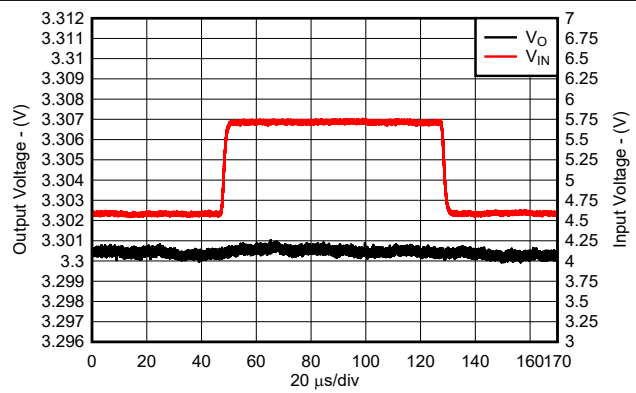

Figure 8-16. Line Transient Response for New Chip

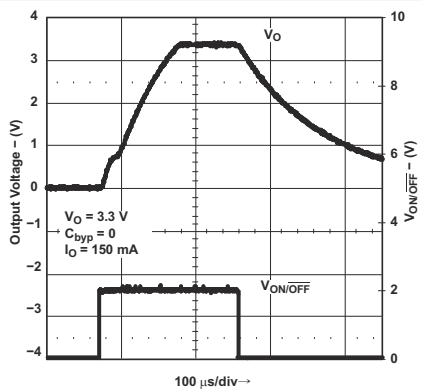

Figure 8-17. Turn-On Time for Legacy Chip

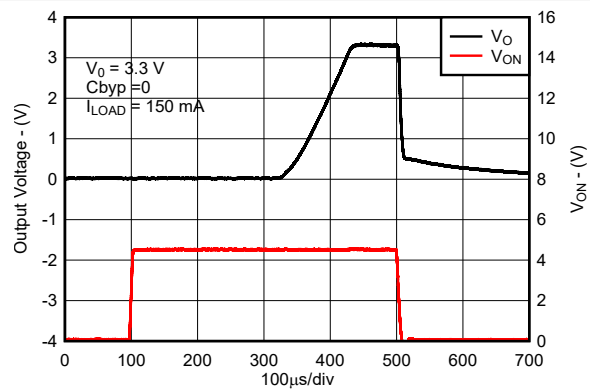

Figure 8-18. Turn-On Time for New Chip

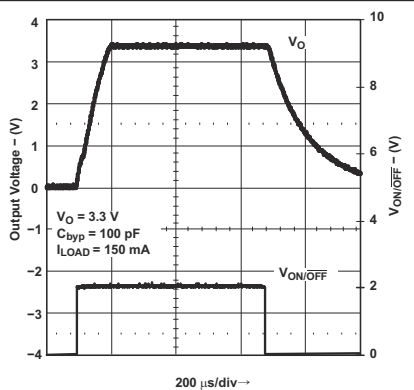

Figure 8-19. Turn-On Time for Legacy Chip

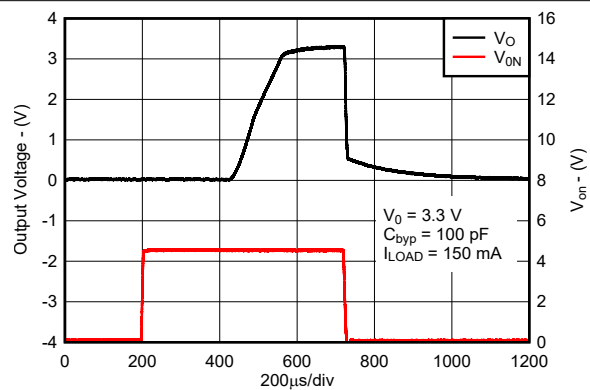

Figure 8-20. Turn-On Time for New Chip

8.2.3 Application Curves (continued)

at operating temperature $T_J = 25^\circ\text{C}$, $V_{IN} = V_{OUT(NOM)} + 1.0\text{ V}$ or 2.5 V (whichever is greater), $I_{OUT} = 1\text{ mA}$, ON/\overline{OFF} pin tied to V_{IN} , $C_{IN} = 1.0\ \mu\text{F}$, and $C_{OUT} = 4.7\ \mu\text{F}$ (unless otherwise noted)

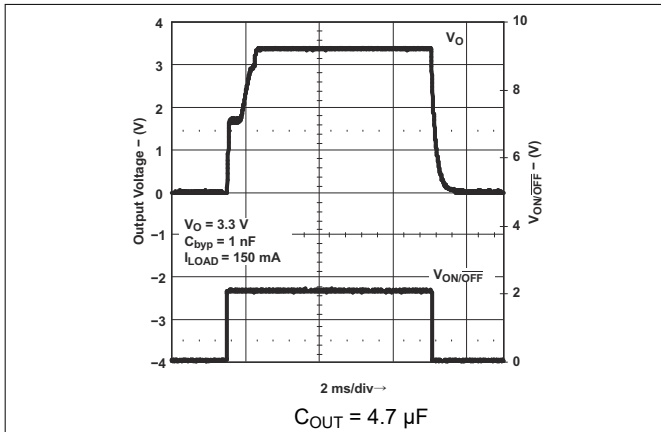

Figure 8-21. Turn-On Time for Legacy Chip

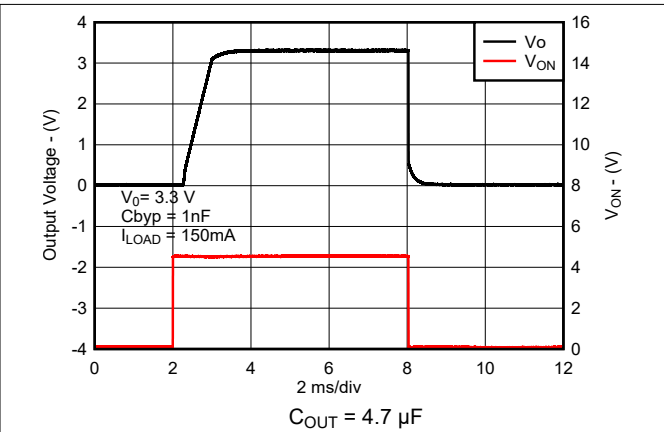

Figure 8-22. Turn-On Time for New Chip

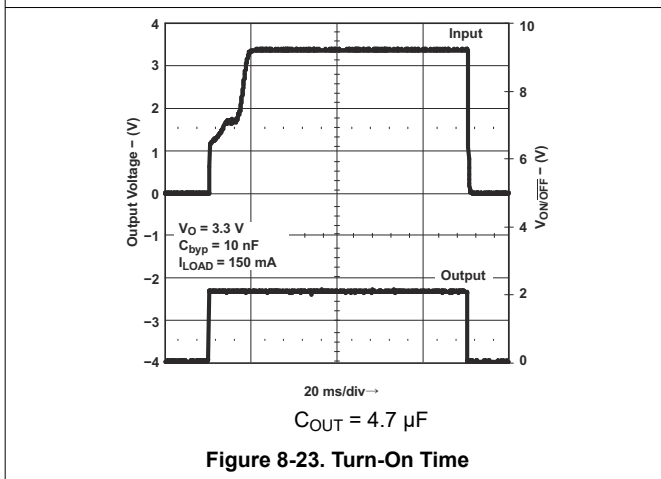

Figure 8-23. Turn-On Time

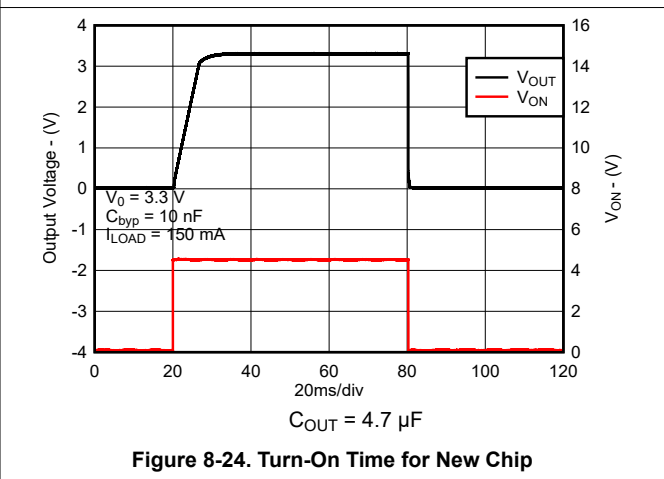

Figure 8-24. Turn-On Time for New Chip

8.3 Power Supply Recommendations

A power supply can be used at the input voltage within the ranges given in the [Recommended Operating Conditions](#) table. Use bypass capacitors as described in the [Layout Guidelines](#) section.

8.4 Layout

8.4.1 Layout Guidelines

- Bypass the input pin to ground with a bypass capacitor.
- The optimum placement of the bypass capacitor is closest to the V_{IN} of the device and GND of the system. Care must be taken to minimize the loop area formed by the bypass capacitor connection, the V_{IN} pin, and the GND pin of the system.
- For operation at full-rated load, use wide trace lengths to eliminate IR drop and heat dissipation.

8.4.2 Layout Example

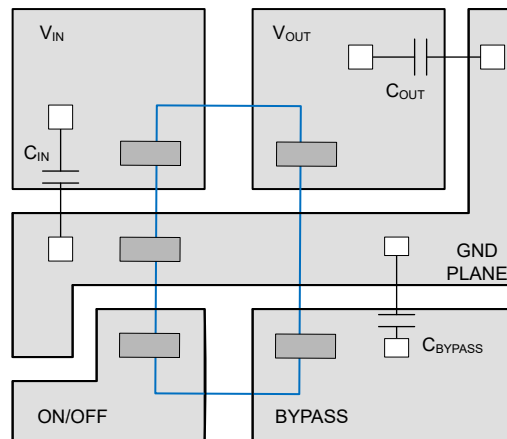

Figure 8-25. Layout Diagram

9 Device and Documentation Support

9.1 Device Nomenclature

Table 9-1. Available Options⁽¹⁾

PRODUCT	V _{OUT}
LP2985- xx yyy Legacy chip	xx is the nominal output voltage (for example, 33 = 3.3 V; 50 = 5.0 V). yyy is the package designator. z is the package quantity. R is for large quantity reel, T is for small quantity reel.
LP2985- xx yyy z M3 New chip	xx is the nominal output voltage (for example, 33 = 3.3 V; 50 = 5.0 V). yyy is the package designator. z is the package quantity. R is for large quantity reel, T is for small quantity reel. M3 is a suffix designator for newer chip redesigns, fabricated on the latest TI process technology.

(1) For the most current package and ordering information, see the Package Option Addendum at the end of this document, or visit the device product folder at www.ti.com.

9.2 Receiving Notification of Documentation Updates

To receive notification of documentation updates, navigate to the device product folder on ti.com. Click on *Subscribe to updates* to register and receive a weekly digest of any product information that has changed. For change details, review the revision history included in any revised document.

9.3 Support Resources

[TI E2E™ support forums](#) are an engineer's go-to source for fast, verified answers and design help — straight from the experts. Search existing answers or ask your own question to get the quick design help you need.

Linked content is provided "AS IS" by the respective contributors. They do not constitute TI specifications and do not necessarily reflect TI's views; see TI's [Terms of Use](#).

9.4 Trademarks

TI E2E™ is a trademark of Texas Instruments.

All trademarks are the property of their respective owners.

9.5 Electrostatic Discharge Caution



This integrated circuit can be damaged by ESD. Texas Instruments recommends that all integrated circuits be handled with appropriate precautions. Failure to observe proper handling and installation procedures can cause damage.

ESD damage can range from subtle performance degradation to complete device failure. Precision integrated circuits may be more susceptible to damage because very small parametric changes could cause the device not to meet its published specifications.

9.6 Glossary

[TI Glossary](#) This glossary lists and explains terms, acronyms, and definitions.

10 Mechanical, Packaging, and Orderable Information

The following pages include mechanical, packaging, and orderable information. This information is the most current data available for the designated devices. This data is subject to change without notice and revision of this document. For browser-based versions of this data sheet, refer to the left-hand navigation.

PACKAGING INFORMATION

Orderable Device	Status (1)	Package Type	Package Drawing	Pins	Package Qty	Eco Plan (2)	Lead finish/ Ball material (6)	MSL Peak Temp (3)	Op Temp (°C)	Device Marking (4/5)	Samples
LP2985-10DBVR	LIFEBUY	SOT-23	DBV	5	3000	RoHS & Green	NIPDAU	Level-1-260C-UNLIM	-40 to 125	LRCG	
LP2985-10DBVT	LIFEBUY	SOT-23	DBV	5	250	RoHS & Green	NIPDAU	Level-1-260C-UNLIM	-40 to 125	LRCG	
LP2985-18DBVR	ACTIVE	SOT-23	DBV	5	3000	RoHS & Green	SN	Level-1-260C-UNLIM	-40 to 125	(LPHG, LPHL)	Samples
LP2985-18DBVRE4	LIFEBUY	SOT-23	DBV	5	3000	RoHS & Green	NIPDAU	Level-1-260C-UNLIM	-40 to 125	LPHG	
LP2985-18DBVRG4	LIFEBUY	SOT-23	DBV	5	3000	RoHS & Green	NIPDAU	Level-1-260C-UNLIM	-40 to 125	LPHG	
LP2985-18DBVRM3	ACTIVE	SOT-23	DBV	5	3000	RoHS & Green	SN	Level-1-260C-UNLIM	-40 to 125	LPHG	Samples
LP2985-18DBVT	LIFEBUY	SOT-23	DBV	5	250	RoHS & Green	NIPDAU SN	Level-1-260C-UNLIM	-40 to 125	(LPHG, LPHL)	
LP2985-18DBVTG4	ACTIVE	SOT-23	DBV	5	250	RoHS & Green	NIPDAU	Level-1-260C-UNLIM	-40 to 125	LPHG	Samples
LP2985-25DBVR	ACTIVE	SOT-23	DBV	5	3000	RoHS & Green	NIPDAU SN	Level-1-260C-UNLIM	-40 to 125	(LPLG, LPLL)	Samples
LP2985-25DBVT	ACTIVE	SOT-23	DBV	5	250	RoHS & Green	NIPDAU	Level-1-260C-UNLIM	-40 to 125	(LPLG, LPLL)	Samples
LP2985-28DBVR	ACTIVE	SOT-23	DBV	5	3000	RoHS & Green	SN	Level-1-260C-UNLIM	-40 to 125	(LPGG, LPGL)	Samples
LP2985-28DBVTG4	ACTIVE	SOT-23	DBV	5	250	RoHS & Green	NIPDAU	Level-1-260C-UNLIM	-40 to 125	LPGG	Samples
LP2985-30DBVR	ACTIVE	SOT-23	DBV	5	3000	RoHS & Green	NIPDAU SN	Level-1-260C-UNLIM	-40 to 125	(LPNG, LPNL)	Samples
LP2985-30DBVRG4	ACTIVE	SOT-23	DBV	5	3000	RoHS & Green	SN	Level-1-260C-UNLIM	-40 to 125	(LPNG, LPNL)	Samples
LP2985-30DBVT	LIFEBUY	SOT-23	DBV	5	250	RoHS & Green	NIPDAU	Level-1-260C-UNLIM	-40 to 125	(LPNG, LPNL)	
LP2985-30DBVTG4	LIFEBUY	SOT-23	DBV	5	250	RoHS & Green	NIPDAU	Level-1-260C-UNLIM	-40 to 125	(LPNG, LPNL)	
LP2985-33DBVR	ACTIVE	SOT-23	DBV	5	3000	RoHS & Green	SN	Level-1-260C-UNLIM	-40 to 125	(LPFG, LPFL)	Samples
LP2985-33DBVRE4	ACTIVE	SOT-23	DBV	5	3000	RoHS & Green	SN	Level-1-260C-UNLIM	-40 to 125	LPFG	Samples
LP2985-33DBVRG4	ACTIVE	SOT-23	DBV	5	3000	RoHS & Green	NIPDAU SN	Level-1-260C-UNLIM	-40 to 125	LPFG	Samples
LP2985-33DBVRM3	ACTIVE	SOT-23	DBV	5	3000	RoHS & Green	SN	Level-1-260C-UNLIM	-40 to 125	LPFG	Samples
LP2985-33DBVT	ACTIVE	SOT-23	DBV	5	250	RoHS & Green	SN	Level-1-260C-UNLIM	-40 to 125	(LPFG, LPFL)	Samples
LP2985-33DBVTE4	LIFEBUY	SOT-23	DBV	5	250	RoHS & Green	NIPDAU	Level-1-260C-UNLIM	-40 to 125	LPFG	
LP2985-33DBVTG4	LIFEBUY	SOT-23	DBV	5	250	RoHS & Green	NIPDAU	Level-1-260C-UNLIM	-40 to 125	LPFG	

Orderable Device	Status (1)	Package Type	Package Drawing	Pins	Package Qty	Eco Plan (2)	Lead finish/ Ball material (6)	MSL Peak Temp (3)	Op Temp (°C)	Device Marking (4/5)	Samples
LP2985-33DBVTM3	ACTIVE	SOT-23	DBV	5	250	RoHS & Green	SN	Level-1-260C-UNLIM	-40 to 125	LPFG	Samples
LP2985-50DBVR	ACTIVE	SOT-23	DBV	5	3000	RoHS & Green	NIPDAU SN	Level-1-260C-UNLIM	-40 to 125	(LPSPG, LPSSL)	Samples
LP2985-50DBVRG4	ACTIVE	SOT-23	DBV	5	3000	RoHS & Green	SN	Level-1-260C-UNLIM	-40 to 125	(LPSPG, LPSSL)	Samples
LP2985-50DBVT	ACTIVE	SOT-23	DBV	5	250	RoHS & Green	NIPDAU SN	Level-1-260C-UNLIM	-40 to 125	(LPSPG, LPSSL)	Samples
LP2985-50DBVTG4	ACTIVE	SOT-23	DBV	5	250	RoHS & Green	SN	Level-1-260C-UNLIM	-40 to 125	(LPSPG, LPSSL)	Samples
LP2985-50DBVTM3	ACTIVE	SOT-23	DBV	5	250	RoHS & Green	SN	Level-1-260C-UNLIM	-40 to 125	LPSPG	Samples
LP2985A-10DBVR	LIFEBUY	SOT-23	DBV	5	3000	RoHS & Green	NIPDAU	Level-1-260C-UNLIM	-40 to 125	LRDG	
LP2985A-10DBVT	LIFEBUY	SOT-23	DBV	5	250	RoHS & Green	NIPDAU	Level-1-260C-UNLIM	-40 to 125	LRDG	
LP2985A-18DBVJ	LIFEBUY	SOT-23	DBV	5	10000	RoHS & Green	NIPDAU	Level-1-260C-UNLIM	-40 to 125	LPTL	
LP2985A-18DBVR	ACTIVE	SOT-23	DBV	5	3000	RoHS & Green	SN	Level-1-260C-UNLIM	-40 to 125	(LPTG, LPTL)	Samples
LP2985A-18DBVRG4	ACTIVE	SOT-23	DBV	5	3000	RoHS & Green	NIPDAU	Level-1-260C-UNLIM	-40 to 125	LPTG	Samples
LP2985A-18DBVT	LIFEBUY	SOT-23	DBV	5	250	RoHS & Green	NIPDAU SN	Level-1-260C-UNLIM	-40 to 125	(LPTG, LPTL)	
LP2985A-25DBVR	ACTIVE	SOT-23	DBV	5	3000	RoHS & Green	NIPDAU SN	Level-1-260C-UNLIM	-40 to 125	(LPUG, LPUL)	Samples
LP2985A-25DBVRG4	ACTIVE	SOT-23	DBV	5	3000	RoHS & Green	SN	Level-1-260C-UNLIM	-40 to 125	(LPUG, LPUL)	Samples
LP2985A-25DBVRM3	ACTIVE	SOT-23	DBV	5	3000	RoHS & Green	NIPDAU	Level-1-260C-UNLIM	-45 to 125	LPUG	Samples
LP2985A-25DBVT	LIFEBUY	SOT-23	DBV	5	250	RoHS & Green	NIPDAU	Level-1-260C-UNLIM	-40 to 125	(LPUG, LPUL)	
LP2985A-28DBVR	LIFEBUY	SOT-23	DBV	5	3000	RoHS & Green	NIPDAU SN	Level-1-260C-UNLIM	-40 to 125	(LPJG, LPJL)	
LP2985A-29DBVR	ACTIVE	SOT-23	DBV	5	3000	RoHS & Green	NIPDAU	Level-1-260C-UNLIM	-40 to 125	(LPZG, LPZL)	Samples
LP2985A-30DBVR	ACTIVE	SOT-23	DBV	5	3000	RoHS & Green	NIPDAU SN	Level-1-260C-UNLIM	-40 to 125	(LRAG, LRAL)	Samples
LP2985A-30DBVT	ACTIVE	SOT-23	DBV	5	250	RoHS & Green	NIPDAU	Level-1-260C-UNLIM	-40 to 125	(LRAG, LRAL)	Samples
LP2985A-33DBVR	ACTIVE	SOT-23	DBV	5	3000	RoHS & Green	SN	Level-1-260C-UNLIM	-40 to 125	(LPKG, LPKL)	Samples
LP2985A-33DBVRG4	ACTIVE	SOT-23	DBV	5	3000	RoHS & Green	NIPDAU SN	Level-1-260C-UNLIM	-40 to 125	LPKG	Samples
LP2985A-33DBVRM3	ACTIVE	SOT-23	DBV	5	3000	RoHS & Green	NIPDAU SN	Level-1-260C-UNLIM	-40 to 125	LPKG	Samples

Orderable Device	Status (1)	Package Type	Package Drawing	Pins	Package Qty	Eco Plan (2)	Lead finish/ Ball material (6)	MSL Peak Temp (3)	Op Temp (°C)	Device Marking (4/5)	Samples
LP2985A-33DBVT	ACTIVE	SOT-23	DBV	5	250	RoHS & Green	SN	Level-1-260C-UNLIM	-40 to 125	(LPFG, LPKG, LPKL)	Samples
LP2985A-33DBVTE4	ACTIVE	SOT-23	DBV	5	250	RoHS & Green	SN	Level-1-260C-UNLIM	-40 to 125	LPKG	Samples
LP2985A-33DBVTG4	ACTIVE	SOT-23	DBV	5	250	RoHS & Green	NIPDAU SN	Level-1-260C-UNLIM	-40 to 125	LPKG	Samples
LP2985A-50DBVR	ACTIVE	SOT-23	DBV	5	3000	RoHS & Green	NIPDAU SN	Level-1-260C-UNLIM	-40 to 125	(LR1G, LR1L)	Samples
LP2985A-50DBVRG4	ACTIVE	SOT-23	DBV	5	3000	RoHS & Green	SN	Level-1-260C-UNLIM	-40 to 125	(LR1G, LR1L)	Samples
LP2985A-50DBVRM3	ACTIVE	SOT-23	DBV	5	3000	RoHS & Green	SN	Level-1-260C-UNLIM	-40 to 125	LR1G	Samples
LP2985A-50DBVT	ACTIVE	SOT-23	DBV	5	250	RoHS & Green	NIPDAU SN	Level-1-260C-UNLIM	-40 to 125	(LPSPG, LR1G, LR1L)	Samples

(1) The marketing status values are defined as follows:

ACTIVE: Product device recommended for new designs.

LIFEBUY: TI has announced that the device will be discontinued, and a lifetime-buy period is in effect.

NRND: Not recommended for new designs. Device is in production to support existing customers, but TI does not recommend using this part in a new design.

PREVIEW: Device has been announced but is not in production. Samples may or may not be available.

OBSOLETE: TI has discontinued the production of the device.

(2) **RoHS:** TI defines "RoHS" to mean semiconductor products that are compliant with the current EU RoHS requirements for all 10 RoHS substances, including the requirement that RoHS substance do not exceed 0.1% by weight in homogeneous materials. Where designed to be soldered at high temperatures, "RoHS" products are suitable for use in specified lead-free processes. TI may reference these types of products as "Pb-Free".

RoHS Exempt: TI defines "RoHS Exempt" to mean products that contain lead but are compliant with EU RoHS pursuant to a specific EU RoHS exemption.

Green: TI defines "Green" to mean the content of Chlorine (Cl) and Bromine (Br) based flame retardants meet JS709B low halogen requirements of <=1000ppm threshold. Antimony trioxide based flame retardants must also meet the <=1000ppm threshold requirement.

(3) MSL, Peak Temp. - The Moisture Sensitivity Level rating according to the JEDEC industry standard classifications, and peak solder temperature.

(4) There may be additional marking, which relates to the logo, the lot trace code information, or the environmental category on the device.

(5) Multiple Device Markings will be inside parentheses. Only one Device Marking contained in parentheses and separated by a "~" will appear on a device. If a line is indented then it is a continuation of the previous line and the two combined represent the entire Device Marking for that device.

(6) Lead finish/Ball material - Orderable Devices may have multiple material finish options. Finish options are separated by a vertical ruled line. Lead finish/Ball material values may wrap to two lines if the finish value exceeds the maximum column width.

Important Information and Disclaimer: The information provided on this page represents TI's knowledge and belief as of the date that it is provided. TI bases its knowledge and belief on information provided by third parties, and makes no representation or warranty as to the accuracy of such information. Efforts are underway to better integrate information from third parties. TI has taken and continues to take reasonable steps to provide representative and accurate information but may not have conducted destructive testing or chemical analysis on incoming materials and chemicals. TI and TI suppliers consider certain information to be proprietary, and thus CAS numbers and other limited information may not be available for release.

In no event shall TI's liability arising out of such information exceed the total purchase price of the TI part(s) at issue in this document sold by TI to Customer on an annual basis.

TAPE AND REEL INFORMATION

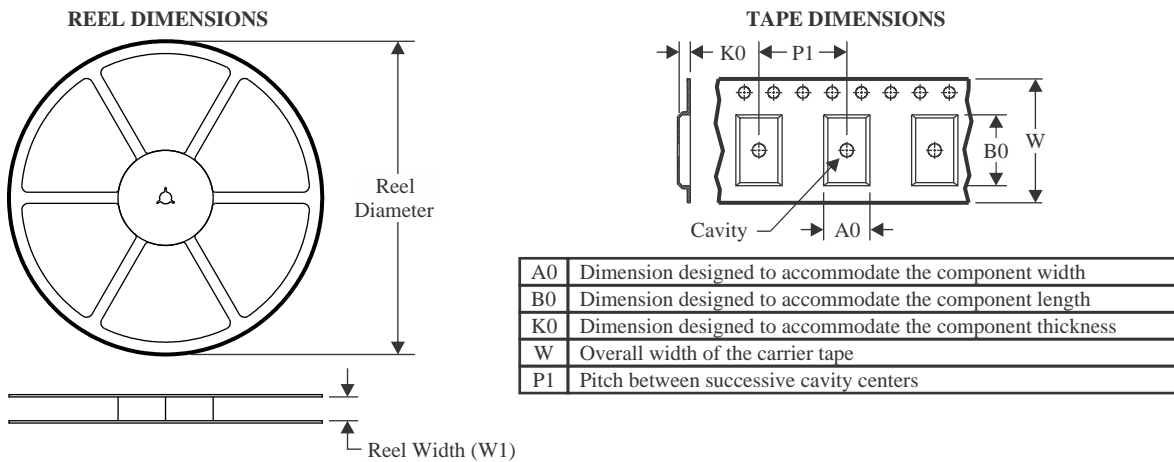

QUADRANT ASSIGNMENTS FOR PIN 1 ORIENTATION IN TAPE



*All dimensions are nominal

Device	Package Type	Package Drawing	Pins	SPQ	Reel Diameter (mm)	Reel Width W1 (mm)	A0 (mm)	B0 (mm)	K0 (mm)	P1 (mm)	W (mm)	Pin1 Quadrant
LP2985-10DBVR	SOT-23	DBV	5	3000	178.0	9.0	3.23	3.17	1.37	4.0	8.0	Q3
LP2985-10DBVT	SOT-23	DBV	5	250	178.0	9.0	3.3	3.2	1.4	4.0	8.0	Q3
LP2985-18DBVR	SOT-23	DBV	5	3000	178.0	9.0	3.3	3.2	1.4	4.0	8.0	Q3
LP2985-18DBVRG4	SOT-23	DBV	5	3000	178.0	9.0	3.3	3.2	1.4	4.0	8.0	Q3
LP2985-18DBVRM3	SOT-23	DBV	5	3000	180.0	8.4	3.2	3.2	1.4	4.0	8.0	Q3
LP2985-18DBVTG4	SOT-23	DBV	5	250	178.0	9.0	3.23	3.17	1.37	4.0	8.0	Q3
LP2985-25DBVR	SOT-23	DBV	5	3000	178.0	9.0	3.3	3.2	1.4	4.0	8.0	Q3
LP2985-28DBVR	SOT-23	DBV	5	3000	178.0	9.0	3.23	3.17	1.37	4.0	8.0	Q3
LP2985-28DBVTG4	SOT-23	DBV	5	250	178.0	9.0	3.3	3.2	1.4	4.0	8.0	Q3
LP2985-30DBVR	SOT-23	DBV	5	3000	178.0	9.0	3.23	3.17	1.37	4.0	8.0	Q3
LP2985-33DBVR	SOT-23	DBV	5	3000	178.0	9.0	3.3	3.2	1.4	4.0	8.0	Q3
LP2985-33DBVRG4	SOT-23	DBV	5	3000	178.0	9.0	3.3	3.2	1.4	4.0	8.0	Q3
LP2985-33DBVRM3	SOT-23	DBV	5	3000	180.0	8.4	3.2	3.2	1.4	4.0	8.0	Q3
LP2985-33DBVT	SOT-23	DBV	5	250	178.0	9.0	3.23	3.17	1.37	4.0	8.0	Q3
LP2985-33DBVTG4	SOT-23	DBV	5	250	178.0	9.0	3.23	3.17	1.37	4.0	8.0	Q3
LP2985-33DBVTM3	SOT-23	DBV	5	250	180.0	8.4	3.2	3.2	1.4	4.0	8.0	Q3

Device	Package Type	Package Drawing	Pins	SPQ	Reel Diameter (mm)	Reel Width W1 (mm)	A0 (mm)	B0 (mm)	K0 (mm)	P1 (mm)	W (mm)	Pin1 Quadrant
LP2985-50DBVR	SOT-23	DBV	5	3000	178.0	9.0	3.23	3.17	1.37	4.0	8.0	Q3
LP2985-50DBVTM3	SOT-23	DBV	5	250	180.0	8.4	3.2	3.2	1.4	4.0	8.0	Q3
LP2985A-10DBVR	SOT-23	DBV	5	3000	178.0	9.0	3.23	3.17	1.37	4.0	8.0	Q3
LP2985A-10DBVT	SOT-23	DBV	5	250	178.0	9.0	3.3	3.2	1.4	4.0	8.0	Q3
LP2985A-18DBVJ	SOT-23	DBV	5	10000	330.0	8.4	3.17	3.23	1.37	4.0	8.0	Q3
LP2985A-18DBVR	SOT-23	DBV	5	3000	178.0	9.0	3.23	3.17	1.37	4.0	8.0	Q3
LP2985A-18DBVRG4	SOT-23	DBV	5	3000	178.0	9.0	3.23	3.17	1.37	4.0	8.0	Q3
LP2985A-25DBVR	SOT-23	DBV	5	3000	178.0	9.0	3.23	3.17	1.37	4.0	8.0	Q3
LP2985A-25DBVRM3	SOT-23	DBV	5	3000	180.0	8.4	3.2	3.2	1.4	4.0	8.0	Q3
LP2985A-25DBVT	SOT-23	DBV	5	250	180.0	9.2	3.17	3.23	1.37	4.0	8.0	Q3
LP2985A-28DBVR	SOT-23	DBV	5	3000	178.0	9.0	3.23	3.17	1.37	4.0	8.0	Q3
LP2985A-28DBVR	SOT-23	DBV	5	3000	180.0	9.2	3.17	3.23	1.37	4.0	8.0	Q3
LP2985A-29DBVR	SOT-23	DBV	5	3000	178.0	9.0	3.23	3.17	1.37	4.0	8.0	Q3
LP2985A-30DBVR	SOT-23	DBV	5	3000	178.0	9.0	3.23	3.17	1.37	4.0	8.0	Q3
LP2985A-33DBVR	SOT-23	DBV	5	3000	178.0	9.0	3.3	3.2	1.4	4.0	8.0	Q3
LP2985A-33DBVRG4	SOT-23	DBV	5	3000	178.0	9.0	3.3	3.2	1.4	4.0	8.0	Q3
LP2985A-33DBVRM3	SOT-23	DBV	5	3000	180.0	8.4	3.2	3.2	1.4	4.0	8.0	Q3
LP2985A-33DBVRM3	SOT-23	DBV	5	3000	180.0	8.4	3.2	3.2	1.4	4.0	8.0	Q3
LP2985A-33DBVT	SOT-23	DBV	5	250	178.0	9.0	3.23	3.17	1.37	4.0	8.0	Q3
LP2985A-33DBVTG4	SOT-23	DBV	5	250	178.0	9.0	3.23	3.17	1.37	4.0	8.0	Q3
LP2985A-50DBVR	SOT-23	DBV	5	3000	178.0	9.0	3.23	3.17	1.37	4.0	8.0	Q3
LP2985A-50DBVRM3	SOT-23	DBV	5	3000	180.0	8.4	3.2	3.2	1.4	4.0	8.0	Q3

TAPE AND REEL BOX DIMENSIONS

*All dimensions are nominal

Device	Package Type	Package Drawing	Pins	SPQ	Length (mm)	Width (mm)	Height (mm)
LP2985-10DBVR	SOT-23	DBV	5	3000	180.0	180.0	18.0
LP2985-10DBVT	SOT-23	DBV	5	250	180.0	180.0	18.0
LP2985-18DBVR	SOT-23	DBV	5	3000	180.0	180.0	18.0
LP2985-18DBVRG4	SOT-23	DBV	5	3000	180.0	180.0	18.0
LP2985-18DBVRM3	SOT-23	DBV	5	3000	210.0	185.0	35.0
LP2985-18DBVTG4	SOT-23	DBV	5	250	180.0	180.0	18.0
LP2985-25DBVR	SOT-23	DBV	5	3000	180.0	180.0	18.0
LP2985-28DBVR	SOT-23	DBV	5	3000	180.0	180.0	18.0
LP2985-28DBVTG4	SOT-23	DBV	5	250	180.0	180.0	18.0
LP2985-30DBVR	SOT-23	DBV	5	3000	180.0	180.0	18.0
LP2985-33DBVR	SOT-23	DBV	5	3000	180.0	180.0	18.0
LP2985-33DBVRG4	SOT-23	DBV	5	3000	180.0	180.0	18.0
LP2985-33DBVRM3	SOT-23	DBV	5	3000	210.0	185.0	35.0
LP2985-33DBVT	SOT-23	DBV	5	250	180.0	180.0	18.0
LP2985-33DBVTG4	SOT-23	DBV	5	250	180.0	180.0	18.0
LP2985-33DBVTM3	SOT-23	DBV	5	250	210.0	185.0	35.0
LP2985-50DBVR	SOT-23	DBV	5	3000	180.0	180.0	18.0
LP2985-50DBVTM3	SOT-23	DBV	5	250	210.0	185.0	35.0

Device	Package Type	Package Drawing	Pins	SPQ	Length (mm)	Width (mm)	Height (mm)
LP2985A-10DBVR	SOT-23	DBV	5	3000	180.0	180.0	18.0
LP2985A-10DBVT	SOT-23	DBV	5	250	180.0	180.0	18.0
LP2985A-18DBVJ	SOT-23	DBV	5	10000	358.0	332.0	35.0
LP2985A-18DBVR	SOT-23	DBV	5	3000	180.0	180.0	18.0
LP2985A-18DBVRG4	SOT-23	DBV	5	3000	180.0	180.0	18.0
LP2985A-25DBVR	SOT-23	DBV	5	3000	180.0	180.0	18.0
LP2985A-25DBVRM3	SOT-23	DBV	5	3000	210.0	185.0	35.0
LP2985A-25DBVT	SOT-23	DBV	5	250	205.0	200.0	33.0
LP2985A-28DBVR	SOT-23	DBV	5	3000	180.0	180.0	18.0
LP2985A-28DBVR	SOT-23	DBV	5	3000	205.0	200.0	33.0
LP2985A-29DBVR	SOT-23	DBV	5	3000	180.0	180.0	18.0
LP2985A-30DBVR	SOT-23	DBV	5	3000	180.0	180.0	18.0
LP2985A-33DBVR	SOT-23	DBV	5	3000	180.0	180.0	18.0
LP2985A-33DBVRG4	SOT-23	DBV	5	3000	180.0	180.0	18.0
LP2985A-33DBVRM3	SOT-23	DBV	5	3000	210.0	185.0	35.0
LP2985A-33DBVRM3	SOT-23	DBV	5	3000	210.0	185.0	35.0
LP2985A-33DBVT	SOT-23	DBV	5	250	180.0	180.0	18.0
LP2985A-33DBVTG4	SOT-23	DBV	5	250	180.0	180.0	18.0
LP2985A-50DBVR	SOT-23	DBV	5	3000	180.0	180.0	18.0
LP2985A-50DBVRM3	SOT-23	DBV	5	3000	210.0	185.0	35.0

EXAMPLE BOARD LAYOUT

DBV0005A

SOT-23 - 1.45 mm max height

SMALL OUTLINE TRANSISTOR



LAND PATTERN EXAMPLE
EXPOSED METAL SHOWN
SCALE:15X

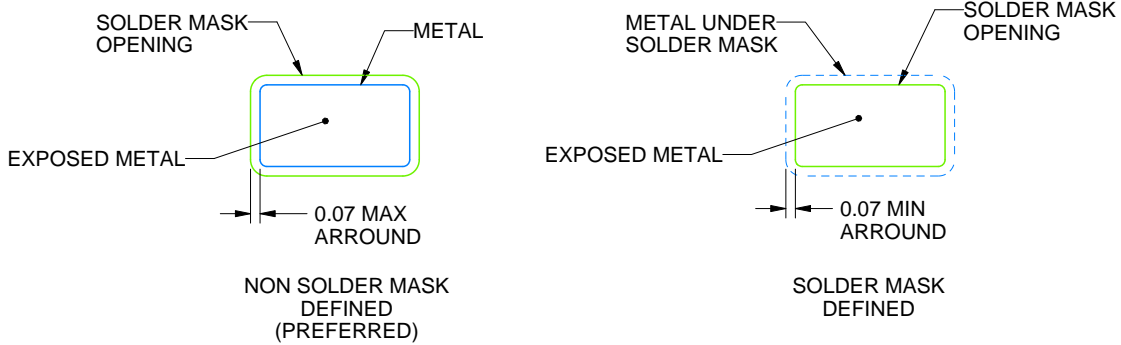

SOLDER MASK DETAILS

4214839/H 09/2023

NOTES: (continued)

- 6. Publication IPC-7351 may have alternate designs.
- 7. Solder mask tolerances between and around signal pads can vary based on board fabrication site.

EXAMPLE STENCIL DESIGN

DBV0005A

SOT-23 - 1.45 mm max height

SMALL OUTLINE TRANSISTOR



SOLDER PASTE EXAMPLE
BASED ON 0.125 mm THICK STENCIL
SCALE:15X

4214839/H 09/2023

NOTES: (continued)

8. Laser cutting apertures with trapezoidal walls and rounded corners may offer better paste release. IPC-7525 may have alternate design recommendations.
9. Board assembly site may have different recommendations for stencil design.

IMPORTANT NOTICE AND DISCLAIMER

TI PROVIDES TECHNICAL AND RELIABILITY DATA (INCLUDING DATA SHEETS), DESIGN RESOURCES (INCLUDING REFERENCE DESIGNS), APPLICATION OR OTHER DESIGN ADVICE, WEB TOOLS, SAFETY INFORMATION, AND OTHER RESOURCES "AS IS" AND WITH ALL FAULTS, AND DISCLAIMS ALL WARRANTIES, EXPRESS AND IMPLIED, INCLUDING WITHOUT LIMITATION ANY IMPLIED WARRANTIES OF MERCHANTABILITY, FITNESS FOR A PARTICULAR PURPOSE OR NON-INFRINGEMENT OF THIRD PARTY INTELLECTUAL PROPERTY RIGHTS.

These resources are intended for skilled developers designing with TI products. You are solely responsible for (1) selecting the appropriate TI products for your application, (2) designing, validating and testing your application, and (3) ensuring your application meets applicable standards, and any other safety, security, regulatory or other requirements.

These resources are subject to change without notice. TI grants you permission to use these resources only for development of an application that uses the TI products described in the resource. Other reproduction and display of these resources is prohibited. No license is granted to any other TI intellectual property right or to any third party intellectual property right. TI disclaims responsibility for, and you will fully indemnify TI and its representatives against, any claims, damages, costs, losses, and liabilities arising out of your use of these resources.

TI's products are provided subject to [TI's Terms of Sale](#) or other applicable terms available either on [ti.com](https://www.ti.com) or provided in conjunction with such TI products. TI's provision of these resources does not expand or otherwise alter TI's applicable warranties or warranty disclaimers for TI products.

TI objects to and rejects any additional or different terms you may have proposed.

Mailing Address: Texas Instruments, Post Office Box 655303, Dallas, Texas 75265
Copyright © 2023, Texas Instruments Incorporated