

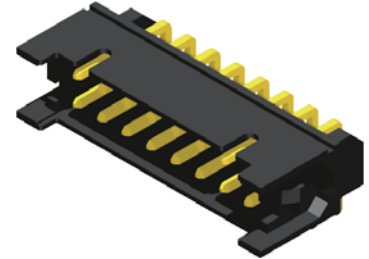

2.0mm Wafer Right Angle / Straight Side Latch Type

Specifications

Current Rating: 3A AC,DC
 Voltage Rating: 250V AC,DC
 Temperature Range: -25°C to +85°C
 Contact Resistance: 10mΩ Max
 Insulation Resistance: 1000MΩ Min
 Withstanding Voltage: 800V AC/minute
 Terminal: Brass / Gold Plated
 Material: Nylon 6T, UL94V-0
 *Mates With 2004H-2XXW1-L



Part No.	Dimensions	
	A	B
2004R-202GB1-U	2.00	8.00
2004R-203GB1-U	4.00	10.00
2004R-204GB1-U	6.00	12.00
2004R-205GB1-U	8.00	14.00
2004R-206GB1-U	10.00	16.00
2004R-207GB1-U	12.00	18.00
2004R-208GB1-U	14.00	20.00
2004R-209GB1-U	16.00	22.00
2004R-210GB1-U	18.00	24.00
2004R-211GB1-U	20.00	26.00
2004R-212GB1-U	22.00	28.00
2004R-213GB1-U	24.00	30.00
2004R-214GB1-U	26.00	32.00
2004R-215GB1-U	28.00	34.00
2004R-216GB1-U	30.00	36.00
2004R-217GB1-U	32.00	38.00
2004R-218GB1-U	34.00	40.00
2004R-219GB1-U	36.00	42.00
2004R-220GB1-U	38.00	44.00

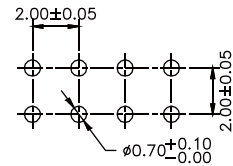
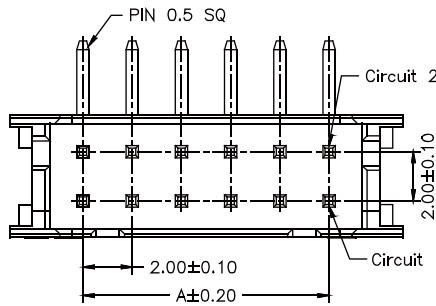

P.C.B LAYOUT

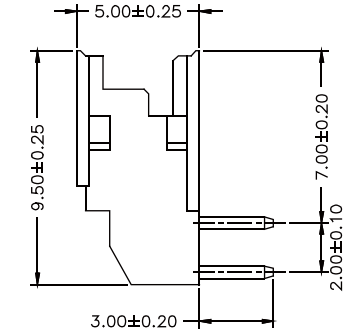
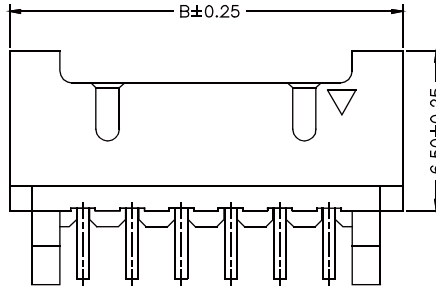

Part No.:2004R-2XXGB1-U

Specifications

Current Rating: 3A AC,DC
 Voltage Rating: 250V AC,DC
 Temperature Range: -25°C to +85°C
 Contact Resistance: 10mΩ Max
 Insulation Resistance: 1000MΩ Min
 Withstanding Voltage: 800V AC/minute
 Terminal: Brass / Gold Plated
 Material: Nylon 6T, UL94V-0
 *Mates With 2004H-2XXW1-L

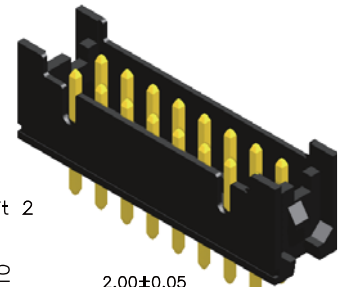

Part No.	Dimensions	
	A	B
2004S-202GB1-U	2.00	8.00
2004S-203GB1-U	4.00	10.00
2004S-204GB1-U	6.00	12.00
2004S-205GB1-U	8.00	14.00
2004S-206GB1-U	10.00	16.00
2004S-207GB1-U	12.00	18.00
2004S-208GB1-U	14.00	20.00
2004S-209GB1-U	16.00	22.00
2004S-210GB1-U	18.00	24.00
2004S-211GB1-U	20.00	26.00
2004S-212GB1-U	22.00	28.00
2004S-213GB1-U	24.00	30.00
2004S-214GB1-U	26.00	32.00
2004S-215GB1-U	28.00	34.00
2004S-216GB1-U	30.00	36.00
2004S-217GB1-U	32.00	38.00
2004S-218GB1-U	34.00	40.00
2004S-219GB1-U	36.00	42.00
2004S-220GB1-U	38.00	44.00
2004S-222GB1-U	42.00	48.00

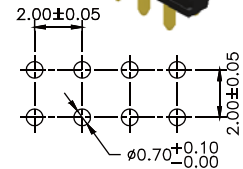
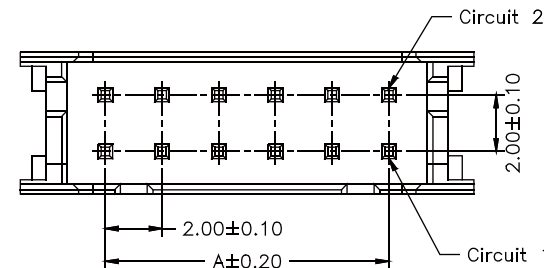

P.C.B LAYOUT

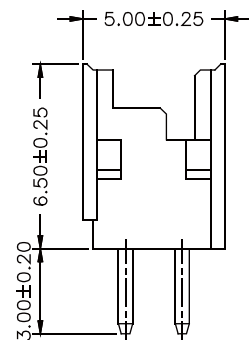
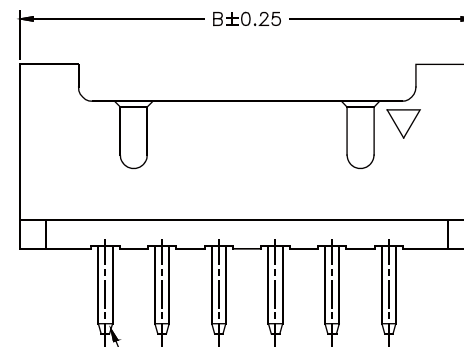

Part No.:2004S-2XXGB1-U

PIN 0.500 SQ

Housing wafer Terminal



ROHS