

CPDH-5V0C-HF

RoHS Device

Halogen Free

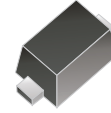

Features

- Bi-directional ESD protection.
- IEC61000-4-2 Level 4 ESD protection.
- Operating voltage: 5V.

Mechanical data

- Case: SOD-523 Standard package, molded plastic.
- Terminals: Solderable per MIL-STD-750D, method 2026.
- Marking code: E05
- Mounting position: Any.
- Weight: 0.0012 grams(approx.)

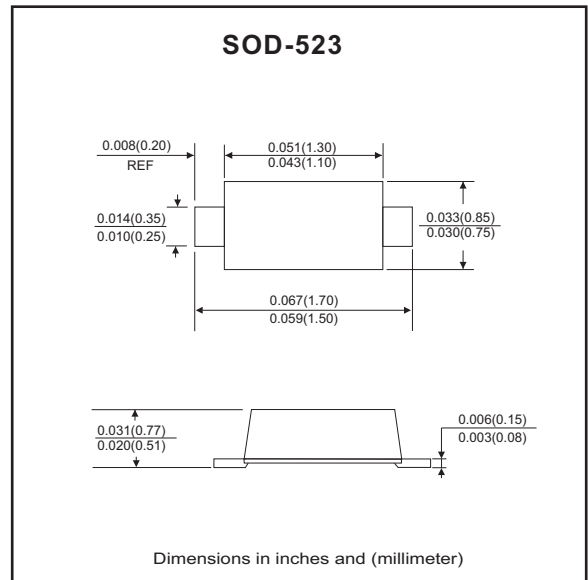

Circuit diagram



Electrical Characteristics (at TA=25°C unless otherwise noted)

Parameter	Conditions	Symbol	Min	Typ	Max	Unit
Diode breakdown voltage	I _R = 1mA	V _{BD}	6.1	7.0		V
Leakage current	V _R = 5V	I _L		0.1	2.0	uA
Junction capacitance	V _R = 0V, f = 1MHz	C _T		25	30	pF
ESD capability	IEC 61000-4-2(air) IEC 61000-4-2(contact)	ESD			16 8	kV
Clamping voltage	I _{PP} = 4A, T _P = 8/20us	V _C			15	V
Operation temperature		T _J			125	°C
Storage temperature		T _{STG}	-55		150	°C

RATING AND CHARACTERISTIC CURVES (CPDH-5V0C-HF)

Fig.1 - 8/20us Peak Pulse Current Wave Form Acc. IEC 6100-4-5

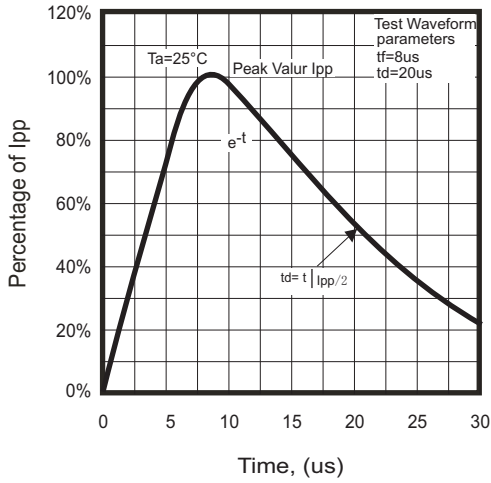

Fig.2 - Reverse Characteristics

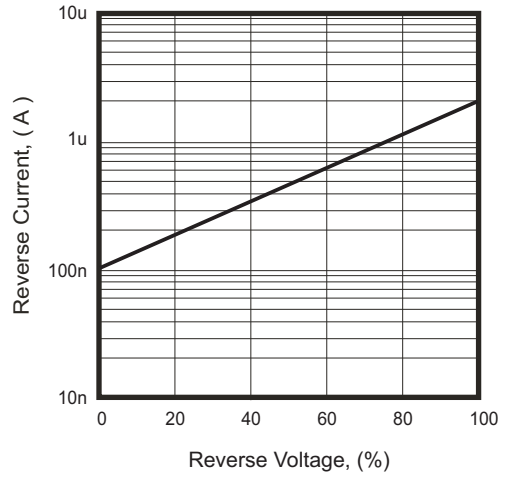

Fig.3 - Capacitance Between Terminals Characteristics

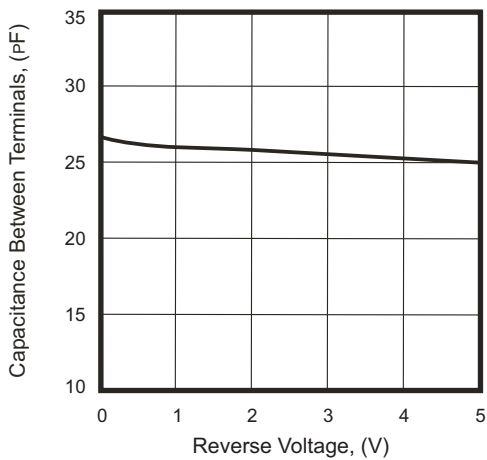
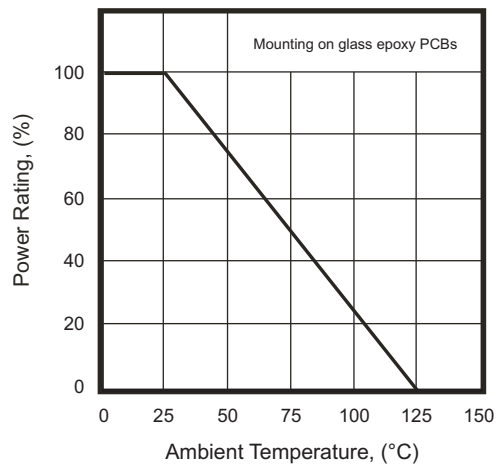
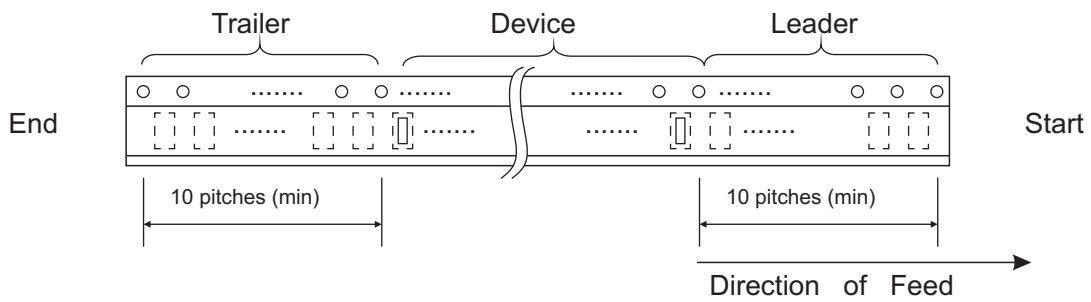
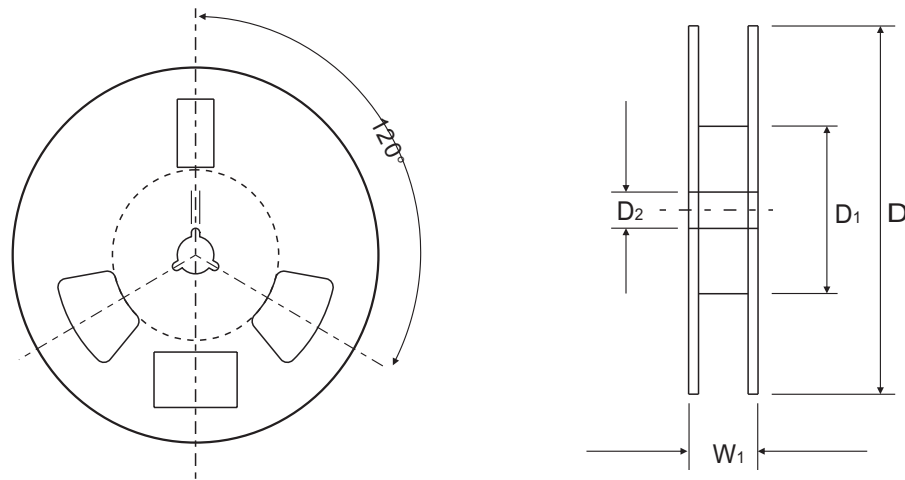
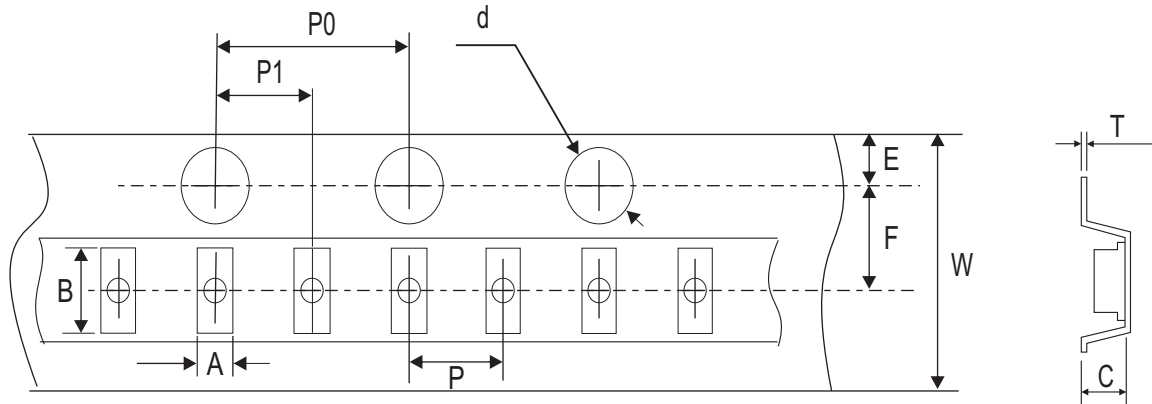

Fig.4 - Power Rating Derating Curve



Reel Taping Specification



SOD-523	SYMBOL	A	B	C	d	D	D ₁	D ₂
	(mm)	0.90 ± 0.05	1.94 ± 0.05	0.73 ± 0.05	1.50 ± 0.10	178 ± 2.00	54.40 ± 1.00	13.00 ± 1.00
	(inch)	0.035 ± 0.002	0.076 ± 0.002	0.029 ± 0.002	0.059 ± 0.004	7.008 ± 0.079	2.142 ± 0.039	0.511 ± 0.039

SOD-523	SYMBOL	E	F	P	P ₀	P ₁	W	W ₁
	(mm)	1.75 ± 0.10	3.50 ± 0.10	2.00 ± 0.10	4.00 ± 0.10	2.00 ± 0.10	8.00 + 0.30 / - 0.10	12.30 ± 1.0
	(inch)	0.069 ± 0.004	0.138 ± 0.004	0.157 ± 0.004	0.157 ± 0.004	0.079 ± 0.004	0.315 + 0.012 / - 0.004	0.484 ± 0.039

Company reserves the right to improve product design , functions and reliability without notice.

Marking Code

Part Number	Marking Code
CPDH-5V0C-HF	E05



Suggested PAD Layout

SIZE	SOD-523	
	(mm)	(inch)
A	1.42	0.056
B	0.60	0.024
C	0.70	0.028
D	2.02	0.080
E	0.82	0.032

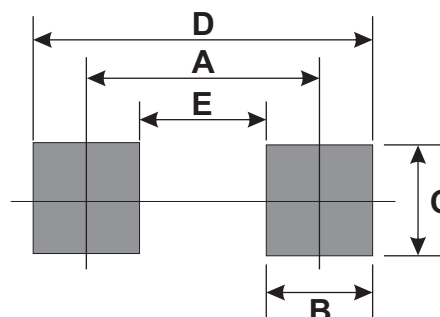

Standard Packaging

Case Type	REEL PACK	
	REEL (pcs)	Reel Size (inch)
SOD-523	3,000	7