T-1³/₄ (5 mm) Precision Optical Performance AlInGaP LED Lamps

Technical Data



HP SunPower Series

HLMP-DLXX	HLMP-ULXX
HLMP-DJXX	HLMP-UJXX
HLMP-DHXX	HLMP-UHXX
HLMP-DGXX	HLMP-UGXX

Features

- **Well Defined Spatial Radiation Patterns**
- **Viewing Angles:** 6°, 15°, 23°, 30°
- **High Luminous Output**
- **Colors:**
 - 590 nm Amber
 - 605 nm Orange
 - 615 nm Reddish-Orange
 - 626 nm Red
- **High Operating Temperature:**
 $T_{j \text{ LED}} = +130^{\circ}\text{C}$
- **Superior Resistance to Moisture**
- **Package Options:**
With or Without Lead Stand-Offs

Benefits

- **Viewing Angles Match Traffic Management Sign Requirements**
- **Colors Meet Automotive and Pedestrian Signal Specifications**
- **Superior Performance in Outdoor Environments**
- **Suitable for Autoinsertion onto PC Boards**

Applications

- **Traffic Management:**
 - Traffic Signals
 - Pedestrian Signals
 - Work Zone Warning Lights
 - Variable Message Signs
- **Commercial Outdoor Advertising:**
 - Signs
 - Marquees
- **Automotive:**
 - Exterior and Interior Lights

Description

These Precision Optical Performance AlInGaP LEDs provide superior light output for excellent readability in sunlight and are extremely reliable. AlInGaP LED technology provides extremely stable light output over long periods of time. Precision Optical Performance lamps utilize the aluminum indium gallium phosphide (AlInGaP) technology.

These LED lamps are untinted, nondiffused, T-1³/₄ packages incorporating second generation optics producing well defined spatial radiation patterns at specific viewing cone angles.

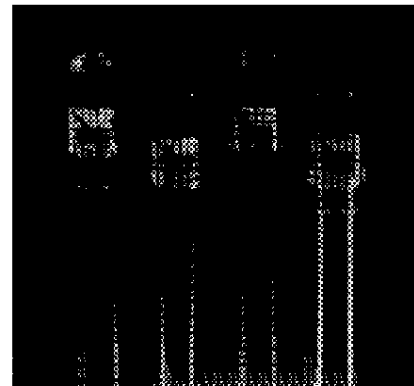

These lamps are made with an advanced optical grade epoxy, offering superior high temperature and high moisture resistance performance in outdoor signal and sign applications. The high maximum LED junction temperature limit of +130°C enables high temperature operation in bright sunlight conditions. The package epoxy contains both uv-a and uv-b inhibitors to reduce the effects of long term exposure to direct sunlight.

These lamps are available in four package options to give the designer flexibility with device mounting.

Device Selection Guide

Part Number HLMP-	Typical Viewing Angle, $2\theta_{1/2}$ (Deg.) ^[4]	Color, Dominant Wavelength, λ_d (nm), ^[3] Typ.	Minimum Luminous Intensity, I_v (mcd), ^[1,2] @ 20 mA	Leads with Stand-Offs	Package Drawing
DL08 ^[5]	6	Amber, 590	3600	No	A
DL10 ^[5]	6	Amber, 590	3600	Yes	B
UL06 ^[5]	6	Amber, 590	1650	No	A
UL07 ^[5]	6	Amber, 590	1650	Yes	B
DJ08 ^[5]	6	Orange, 605	4700	No	A
DJ10 ^[5]	6	Orange, 605	4700	Yes	B
UJ06 ^[5]	6	Orange, 605	2170	No	A
UJ07 ^[5]	6	Orange, 605	2170	Yes	B
DH08 ^[5]	6	Red-Orange, 615	2750	No	A
DH10 ^[5]	6	Red-Orange, 615	2750	Yes	B
UH06 ^[5]	6	Red-Orange, 615	1300	No	A
UH07 ^[5]	6	Red-Orange, 615	1300	Yes	B
DG08 ^[5]	6	Red, 626	2750	No	A
DG10 ^[5]	6	Red, 626	2750	Yes	B
UG06 ^[5]	6	Red, 626	1000	No	A
UG07 ^[5]	6	Red, 626	1000	Yes	B
DL15	15	Amber, 590	1650	No	A
DL17	15	Amber, 590	1650	Yes	B
UL13	15	Amber, 590	765	No	A
UL14	15	Amber, 590	765	Yes	B
DJ15	15	Orange, 605	1300	No	A
DJ17	15	Orange, 605	1300	Yes	B
UJ13	15	Orange, 605	765	No	A
UJ14	15	Orange, 605	765	Yes	B
DH15	15	Red-Orange, 615	1300	No	A
DH17	15	Red-Orange, 615	1300	Yes	B
UH13	15	Red-Orange, 615	450	No	A
UH14	15	Red-Orange, 615	450	Yes	B
DG15	15	Red, 626	1300	No	A
DG17	15	Red, 626	1300	Yes	B
UG13	15	Red, 626	450	No	A
UG14	15	Red, 626	450	Yes	B

Notes:

1. The luminous intensity is measured on the mechanical axis of the lamp package.
2. The optical axis is closely aligned with the package mechanical axis.
3. The dominant wavelength, λ_d , is derived from the CIE Chromaticity Diagram and represents the color of the lamp.
4. $\theta_{1/2}$ is the off-axis angle where the luminous intensity is one half the on-axis intensity.
5. The intensity of narrow viewing angle lamps is measured at the intensity peak.

Device Selection Guide, continued

Part Number HLMP-	Typical Viewing Angle, $2\theta_{1/2}$ (Deg.) ^[4]	Color, Dominant Wavelength, λ_d (nm), ^[3] Typ.	Minimum Luminous Intensity, I_v (mcd), ^[1,2] @ 20 mA	Leads with Stand-Offs	Package Drawing
DL24	23	Amber, 590	1000	No	A
DL26	23	Amber, 590	1000	Yes	B
UL22	23	Amber, 590	450	No	A
UL23	23	Amber, 590	450	Yes	B
DJ24	23	Orange, 605	1000	No	A
DJ26	23	Orange, 605	1000	Yes	B
UJ22	23	Orange, 605	270	No	A
UJ23	23	Orange, 605	270	Yes	B
DH24	23	Red-Orange, 615	765	No	A
DH26	23	Red-Orange, 615	765	Yes	B
UH22	23	Red-Orange, 615	270	No	A
UH23	23	Red-Orange, 615	270	Yes	B
DG24	23	Red, 626	765	No	A
DG26	23	Red, 626	765	Yes	B
UG22	23	Red, 626	270	No	A
UG23	23	Red, 626	270	Yes	B
DL30	30	Amber, 590	765	No	A
DL32	30	Amber, 590	765	Yes	B
UL28	30	Amber, 590	300	No	A
UL29	30	Amber, 590	300	Yes	B
DJ30	30	Orange, 605	765	No	A
DJ32	30	Orange, 605	765	Yes	B
UJ28	30	Orange, 605	205	No	A
UJ29	30	Orange, 605	205	Yes	B
DH30	30	Red-Orange, 615	450	No	A
DH32	30	Red-Orange, 615	450	Yes	B
UH28	30	Red-Orange, 615	205	No	A
UH29	30	Red-Orange, 615	205	Yes	B
DG30	30	Red, 626	450	No	A
DG32	30	Red, 626	450	Yes	B
UG28	30	Red, 626	205	No	A
UG29	30	Red, 626	205	Yes	B

Notes:

1. The luminous intensity is measured on the mechanical axis of the lamp package.
2. The optical axis is closely aligned with the package mechanical axis.
3. The dominant wavelength, λ_d , is derived from the CIE Chromaticity Diagram and represents the color of the lamp.
4. $\theta_{1/2}$ is the off-axis angle where the luminous intensity is one half the on-axis intensity.
5. The intensity of narrow viewing angle lamps is measured at the intensity peak.

Package Dimensions

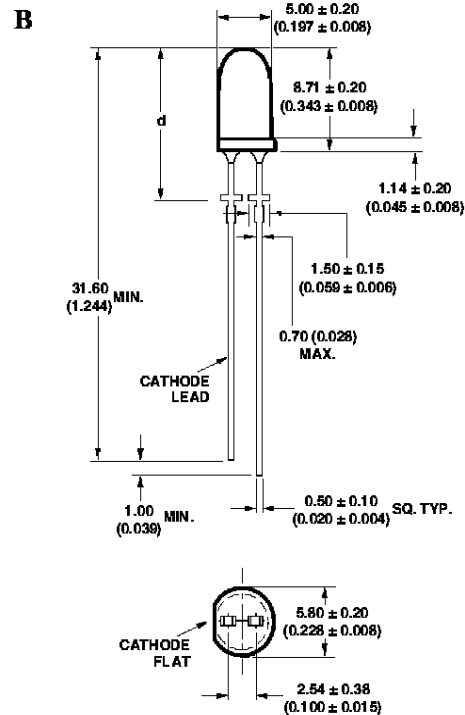
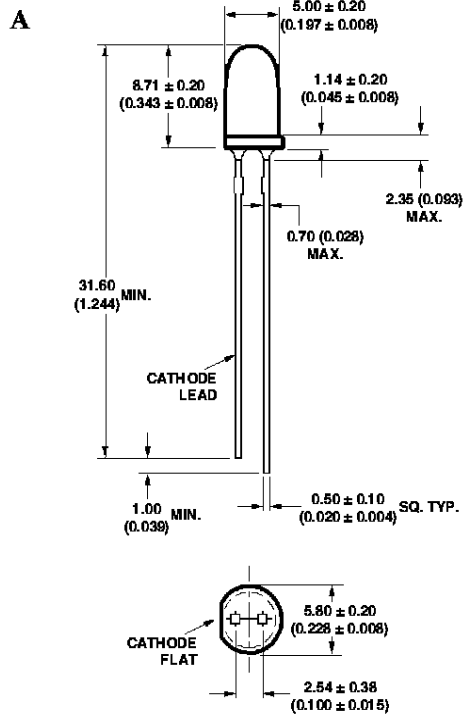

NOTES:

- ALL DIMENSIONS ARE IN MILLIMETERS (INCHES).
- LEADS ARE MILD STEEL, SOLDER DIPPED.
- TAPERS SHOWN AT TOP OF LEADS (BOTTOM OF LAMP PACKAGE) INDICATE AN EPOXY MENISCUS THAT MAY EXTEND ABOUT 1 mm (0.040 in.) DOWN THE LEADS.
- RECOMMENDED PC BOARD HOLE DIAMETERS:
 - LAMP PACKAGE A WITHOUT STAND-OFFS: FLUSH MOUNTING AT BASE OF LAMP PACKAGE = $1.143/1.067$ ($0.044/0.042$).
 - LAMP PACKAGE B WITH STAND-OFFS: MOUNTING AT LEAD STAND-OFFS = $0.965/0.889$ ($0.038/0.035$).
- FOR DOME HEIGHTS ABOVE LEAD STAND-OFF SEATING PLANE, d , LAMP PACKAGE B, SEE TABLE.

PART NO.	d
HLMP-XX10 -XX07	12.37 ± 0.25 (0.487 ± 0.010)
HLMP-XX17 -XX14	12.42 ± 0.25 (0.489 ± 0.010)
HLMP-XX26 -XX23	12.52 ± 0.25 (0.493 ± 0.010)
HLMA-XX32 -XX29	11.96 ± 0.25 (0.471 ± 0.010)

Absolute Maximum Ratings at $T_A = 25^\circ\text{C}$

DC Forward Current ^[1,2,3]	50 mA
Peak Pulsed Forward Current ^[2,3]	70 mA
Average Forward Current ^[3]	30 mA
Reverse Voltage ($I_R = 100 \mu\text{A}$)	5 V
LED Junction Temperature	130°C
Operating Temperature	-40°C to +100°C
Storage Temperature	-40°C to +120°C
Soldering Temperature	260°C for 5 seconds [1.59 mm (0.060 in.) below seating plane]

Notes:

1. Derate linearly as shown in Figure 4.
2. For long term performance with minimal light output degradation, drive currents between 10 mA and 30 mA are recommended.
3. Please contact your Hewlett-Packard sales representative about operating currents below 10 mA.

Electrical/Optical Characteristics at $T_A = 25^\circ\text{C}$

Parameter	Symbol	Min.	Typ.	Max.	Units	Test Conditions
Forward Voltage Amber ($\lambda_d = 590 \text{ nm}$) Orange ($\lambda_d = 605 \text{ nm}$) Red-Orange ($\lambda_d = 615 \text{ nm}$) Red ($\lambda_d = 626 \text{ nm}$)	V_F		2.02 1.98 1.94 1.90	2.4	V	$I_F = 20 \text{ mA}$
Reverse Voltage	V_R	5	20		V	$I_F = 100 \mu\text{A}$
Peak Wavelength: Amber ($\lambda_d = 590 \text{ nm}$) Orange ($\lambda_d = 605 \text{ nm}$) Red-Orange ($\lambda_d = 615 \text{ nm}$) Red ($\lambda_d = 626 \text{ nm}$)	λ_{PEAK}		592 609 621 635		nm	Peak of Wavelength of Spectral Distribution at $I_F = 20 \text{ mA}$
Spectral Halfwidth	$\Delta\lambda_{1/2}$		17		nm	Wavelength Width at Spectral Distribution $1/2$ Power Point at $I_F = 20 \text{ mA}$
Speed of Response	τ_s		20		ns	Exponential Time Constant, e^{-t/τ_s}
Capacitance	C		40		pF	$V_F = 0$, $f = 1 \text{ MHz}$
Thermal Resistance	$R\theta_{\text{J-PIN}}$		240		°C/W	LED Junction-to-Cathode Lead
Luminous Efficacy ^[1] Amber ($\lambda_d = 590 \text{ nm}$) Orange ($\lambda_d = 605 \text{ nm}$) Red-Orange ($\lambda_d = 615 \text{ nm}$) Red ($\lambda_d = 626 \text{ nm}$)	η_v		480 370 260 150		lm/W	Emitted Luminous Power/Emitted Radiant Power

Note:

1. The radiant intensity, I_e , in watts per steradian, may be found from the equation $I_e = I_v/\eta_v$, where I_v is the luminous intensity in candelas and η_v is the luminous efficacy in lumens/watt.

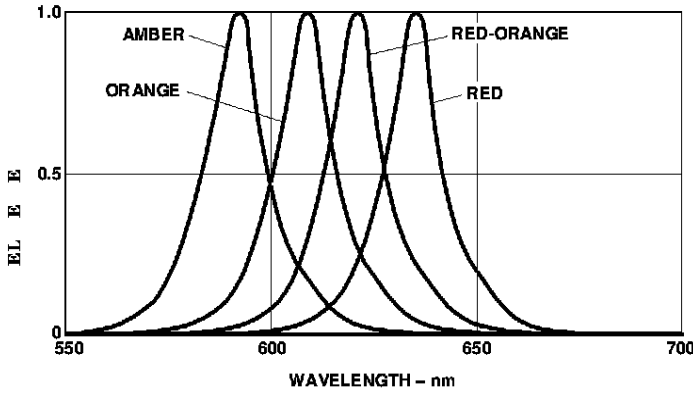

Figure 1. Relative Intensity vs. Peak Wavelength.

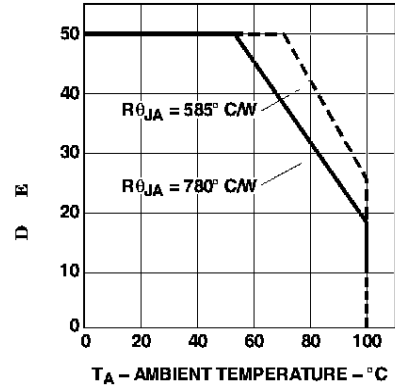

Figure 4. Maximum Forward Current vs. Ambient Temperature. Derating Based on $T_{JMAX} = 130^{\circ}C$.

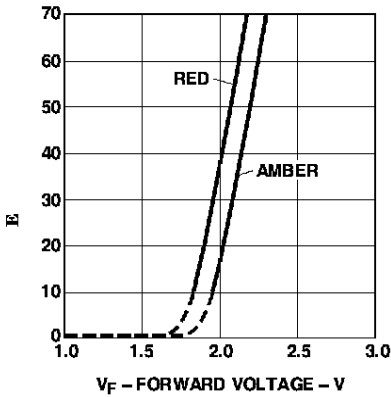

Figure 2. Forward Current vs. Forward Voltage.

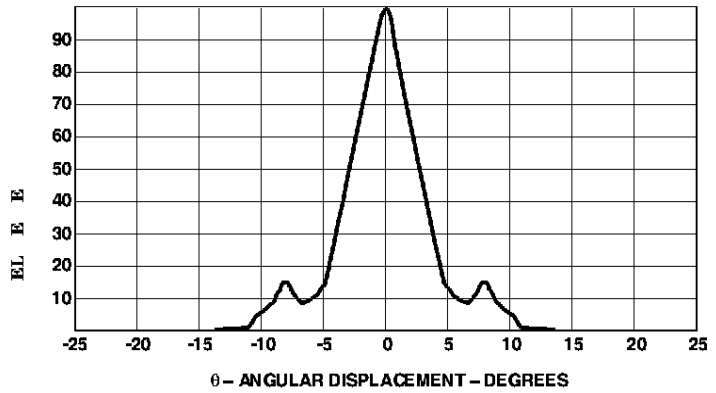

Figure 5. Representative Spatial Radiation Pattern for 6 ° Viewing Angle Lamps.

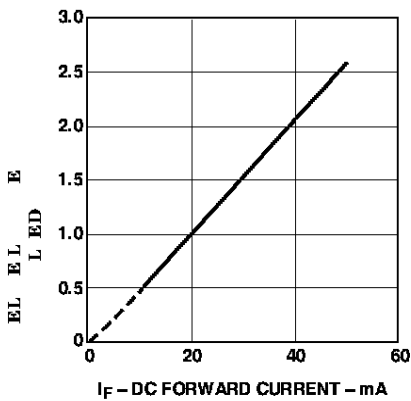

Figure 3. Relative Luminous Intensity vs. Forward Current.

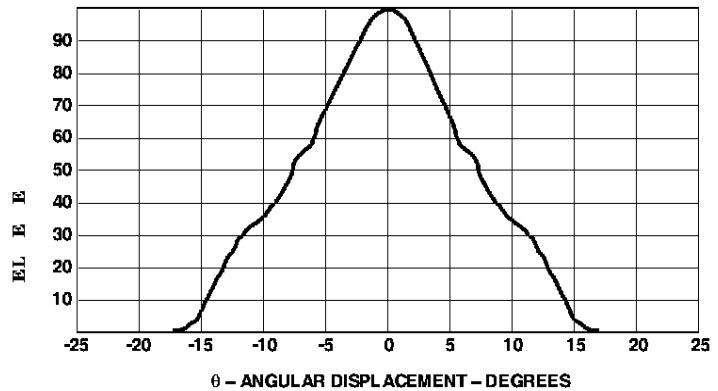

Figure 6. Representative Spatial Radiation Pattern for 15° Viewing Angle Lamps.

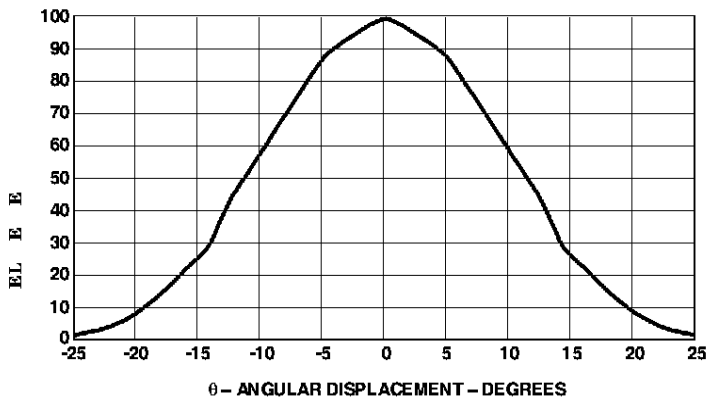

Figure 7. Representative Spatial Radiation Pattern for 23° Viewing Angle Lamps.

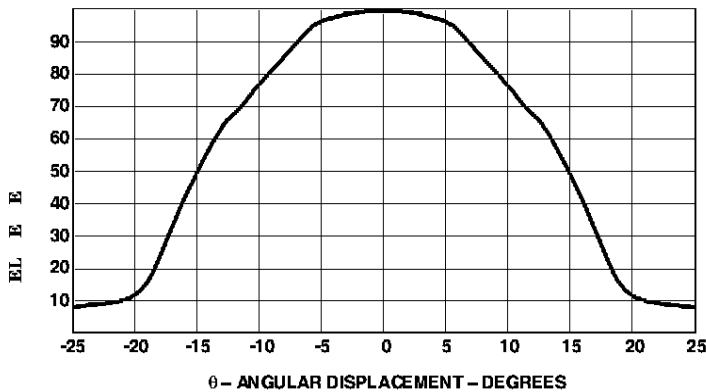

Figure 8. Representative Spatial Radiation Pattern for 30° Viewing Angle Lamps.

Intensity Bin Limits (mcd at 20 mA)

Bin Name	Min.	Max.
JJ	240	310
KK	310	400
LL	400	520
MM	520	680
NN	680	880
PP	880	1150
QQ	1150	1500
RR	1500	1900
SS	1900	2500
TT	2500	3200
UU	3200	4200
VV	4200	5500
WW	5500	7200
XX	7200	9300
YY	9300	12000
ZZ	12000	16000

Tolerance for each bin limit is $\pm 15\%$.

HLMP-xLxx Color Bin Limits (nm at 20 mA)

Bin Name	Min.	Max.
1	584.5	587.0
2	587.0	589.5
4	589.5	592.0
6	592.0	594.5

Tolerance for each bin limit is ± 0.5 nm.

Note:

- Bin categories are established for classification of products. Products may not be available in all bin categories. Please contact your Hewlett-Packard representative for information on currently available bins.



www.hp.com/go/led_lamps

For technical assistance or the location of your nearest Hewlett-Packard sales office, distributor or representative call:

Americas/Canada: 1-800-235-0312 or 408-654-8675

Far East/Australasia: Call your local HP sales office.

Japan: (81 3) 3335-8152

Europe: Call your local HP sales office.

Data subject to change.

Copyright © 1998 Hewlett-Packard Co.

Obsoletes 5965-6807E

Printed in U.S.A. 5968-0948E (8/98)