

Description

- Surface mount oscillator in a ceramic package with a hermetically sealed metal lid
- Model IQXO-70
- Model Issue number 11

Frequency Parameters

- Frequency 20.0MHz
- Frequency Stability $\pm 25.00\text{ppm}$
- Operating Temperature Range -10.00 to 70.00°C
- Ageing $\pm 5\text{ppm}$ max in 1st year

Electrical Parameters

- Supply Voltage $5.0\text{V} \pm 0.5\text{V}$
- Current Draw 27.00mA

Output Details

- Output Compatibility HCMOS
- Drive Capability 50pF max
- Rise and Fall Time 7.0ns max
- Duty Cycle $45/55\%$

Output Control

- Tri-state Operation:
 Logic '1' (2.2V min) to pad 1 enables oscillator output
 Logic '0' (0.8V max) to pad 1 disables oscillator output; when disabled the oscillator output goes to the high impedance state
 No connection to pad 1 enables oscillator output

Environmental Parameters

- Shock: MIL-STD-202F, Method 213B: 1000G, 0.5ms, 1/2 sine
- Vibration: MIL-STD-202F, Method 204D, Test Condition D: 20G, frequency range 10-2000Hz 2hrs in 3 mutually perpendicular planes (total 6hrs)
- Storage Temperature Range: -55 to 125°C

Compliance

- RoHS Status (2011/65/EU) Compliant
- REACH Status Compliant
- MSL Rating (JEDEC-STD-033): Not Applicable

Packaging Details

- Pack Style: Reel Tape & reel in accordance with EIA-481-D
 Pack Size: 1,000
- *Alternative packing option available*

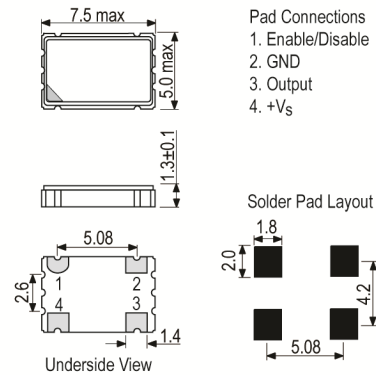
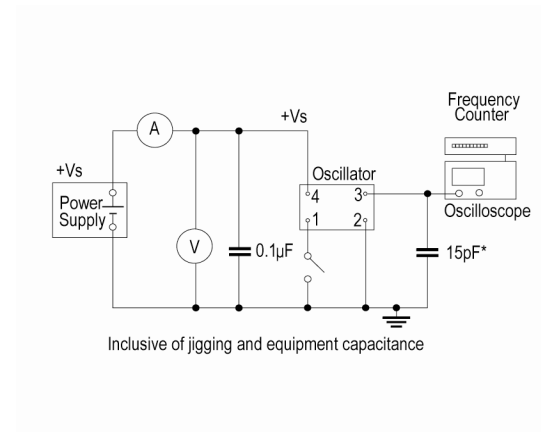
Outline (mm)

Test Circuit

Sales Office Contact Details:

UK: +44 (0)1460 270200
 Germany: 0800 1808 443

France: 0800 901 383
 USA: +1.760.318.2824

Email: info@iqdfrequencyproducts.com
 Web: www.iqdfrequencyproducts.com

Wave Form



Sales Office Contact Details:

UK: +44 (0)1460 270200
Germany: 0800 1808 443

France: 0800 901 383
USA: +1.760.318.2824

Email: info@iqdfrequencyproducts.com
Web: www.iqdfrequencyproducts.com