

## MS2176

### RF AND MICROWAVE TRANSISTORS UHF PULSED APPLICATIONS

#### Features

- 350 WATTS @ 10 $\mu$ SEC PULSE WIDTH, 10% DUTY CYCLE
- 300 WATTS @ 250 $\mu$ SEC PULSE WIDTH 10% DUTY CYCLE
- 9.5 DB MIN. GAIN
- REFRACTORY GOLD METALLIZATION
- EMITTER BALLASTING AND LOW THERMAL RESISTANCE FOR RELIABILITY AND RUGGEDNESS
- INFINITE VSWR CAPABILITY AT SPECIFIED OPERATING CONDITIONS

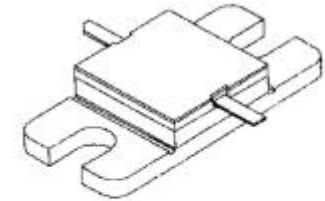

.400 x .400 2LFL (M106)  
hermetically sealed

#### PIN CONNECTION

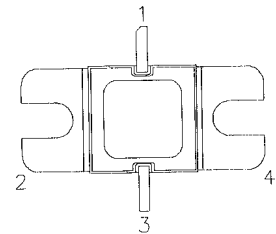

1. Collector      3. Emitter  
2. Base          4. Base

#### DESCRIPTION:

The MS2176 is a gold metallized silicon NPN pulse power transistor designed for applications requiring high peak power and low duty cycles within the frequency range of 400 – 500 MHz.

#### ABSOLUTE MAXIMUM RATINGS (T<sub>case</sub> = 25°C)

Symbol	Parameter	Value	Unit
V <sub>CBO</sub>	Collector-Base Voltage	65	V
V <sub>CES</sub>	Collector-Emitter Voltage	65	V
V <sub>EBO</sub>	Emitter-Base Voltage	3.5	V
I <sub>C</sub>	Device Current	21.6	A
P <sub>DISS</sub>	Power Dissipation	875	W
T <sub>J</sub>	Junction Temperature	+200	°C
T <sub>STG</sub>	Storage Temperature	-65 to +150	°C

#### Thermal Data

R <sub>TH(j-c)</sub>	Junction-Case Thermal Resistance	0.2	°C/W
----------------------	----------------------------------	-----	------

**ELECTRICAL SPECIFICATIONS (T<sub>case</sub> = 25°C)**
**STATIC**

Symbol	Test Conditions	Value			Units
		Min.	Typ.	Max.	
<b>BV<sub>CBO</sub></b>	<b>I<sub>C</sub> = 50 mA    I<sub>E</sub> = 0 mA</b>	<b>65</b>			<b>V</b>
<b>BV<sub>CES</sub></b>	<b>I<sub>C</sub> = 50 mA    V<sub>BE</sub> = 0 V</b>	<b>65</b>			<b>V</b>
<b>BV<sub>CEO</sub></b>	<b>I<sub>C</sub> = 50 mA    I<sub>B</sub> = 0 mA</b>	<b>28</b>			<b>V</b>
<b>BV<sub>EBO</sub></b>	<b>I<sub>E</sub> = 10 mA    I<sub>C</sub> = 0 mA</b>	<b>3.5</b>			<b>V</b>
<b>I<sub>CES</sub></b>	<b>V<sub>CE</sub> = 30 V    I<sub>E</sub> = 0 mA</b>			<b>7.5</b>	<b>mA</b>
<b>h<sub>FE</sub></b>	<b>V<sub>CE</sub> = 5 V    I<sub>C</sub> = 5 A</b>	<b>10</b>		<b>100</b>	

**DYNAMIC**

Symbol	Test Conditions	Value			Units
		Min.	Typ.	Max.	
<b>P<sub>OUT</sub></b>	<b>f = 425 MHz    P<sub>IN</sub> = 33.5 W    V<sub>CE</sub> = 40 V</b>	<b>300</b>			<b>W</b>
<b>G<sub>P</sub></b>	<b>f = 425 MHz    P<sub>IN</sub> = 300 W    V<sub>CE</sub> = 40 V</b>	<b>9.5</b>			<b>dB</b>
<b>ζ<sub>C</sub></b>	<b>f = 425 MHz    P<sub>IN</sub> = 25 W    V<sub>CE</sub> = 40 V</b>	<b>55</b>			<b>%</b>

Note: Pulse Width = 250μSec, Duty Cycle = 10%

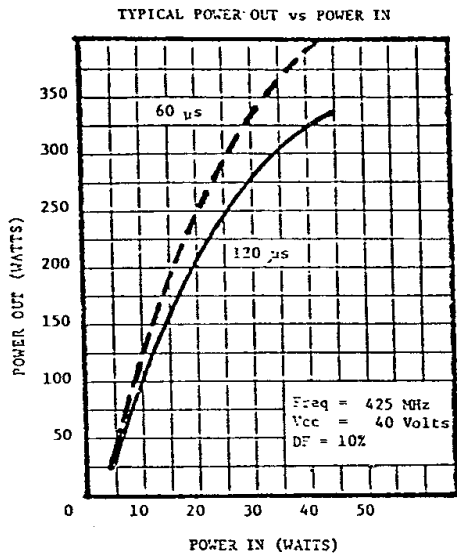
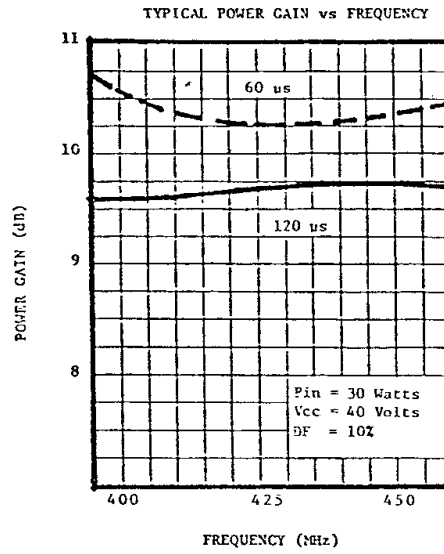
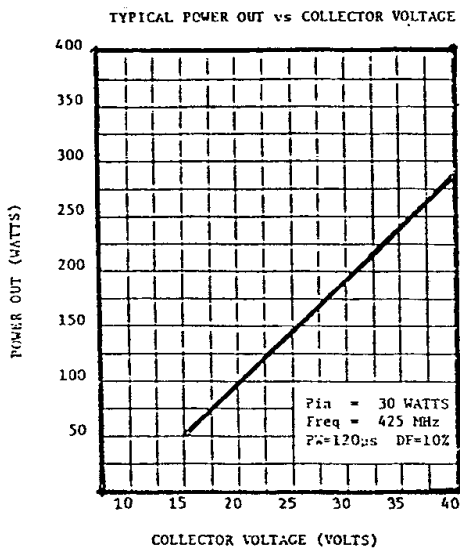
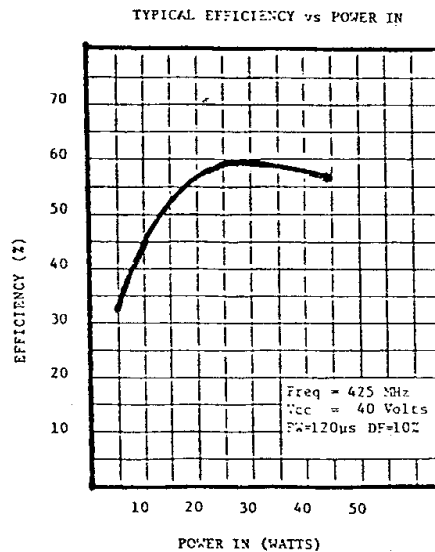
**TYPICAL PERFORMANCE**
**POWER OUTPUT vs POWER INPUT**

**POWER GAIN vs FREQUENCY**

**POWER OUTPUT vs COLLECTOR VOLTAGE**

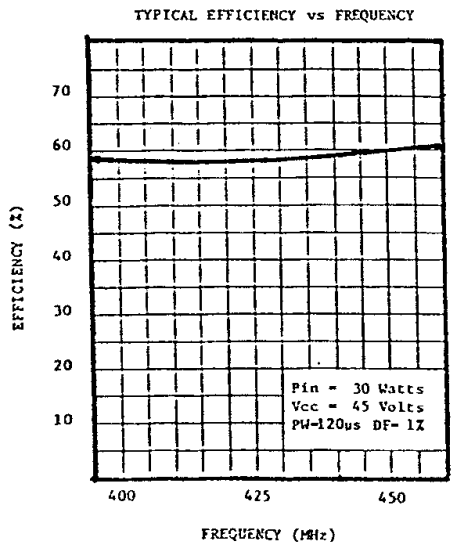
**EFFICIENCY vs POWER INPUT**

TYPICAL PERFORMANCE (CONTINUED)

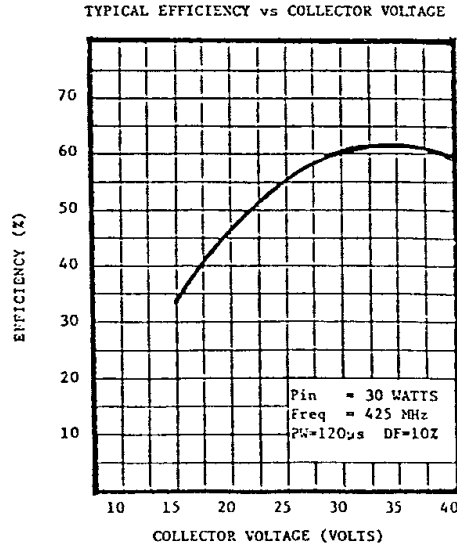
**EFFICIENCY vs FREQUENCY**



**EFFICIENCY vs COLLECTOR VOLTAGE**



TYPICAL PERFORMANCE (CONTINUED)

**POWER GAIN vs FREQUENCY**

TYPICAL POWER GAIN VS FREQUENCY

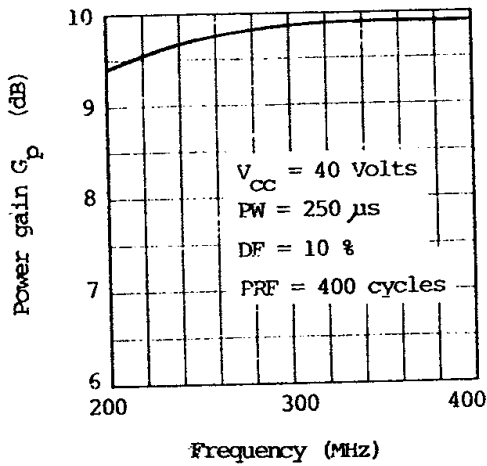

**EFFICIENCY vs FREQUENCY**

TYPICAL EFFICIENCY VS FREQUENCY

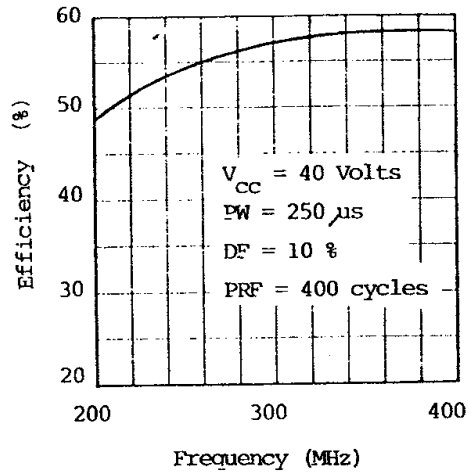

**POWER OUTPUT vs FLANGE  
T<sub>J</sub> @ CONSTANT 125°C**

TYPICAL POWER OUT vs FLANGE  
TEMPERATURE: T<sub>J</sub> AT CONSTANT 125°C  
PULSE WIDTH: 250μs

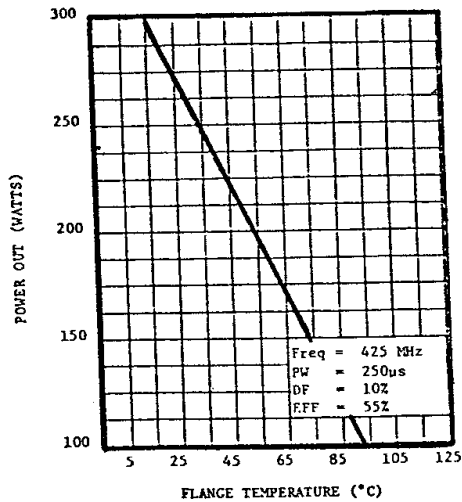

**THERMAL RESISTANCE vs  
PULSE WIDTH**

TYPICAL THERMAL RESISTANCE vs PULSE WIDTH

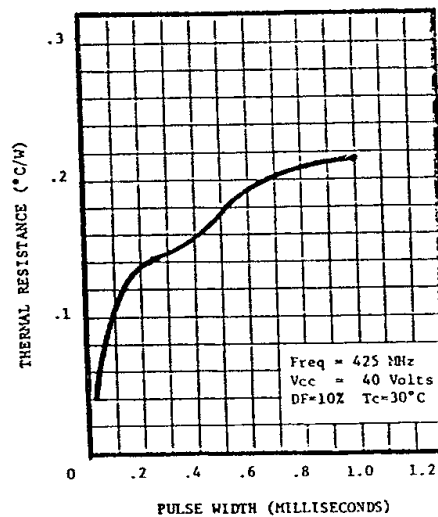

PACKAGE MECHANICAL DATA

Ref.: Dwg. No.12-0106

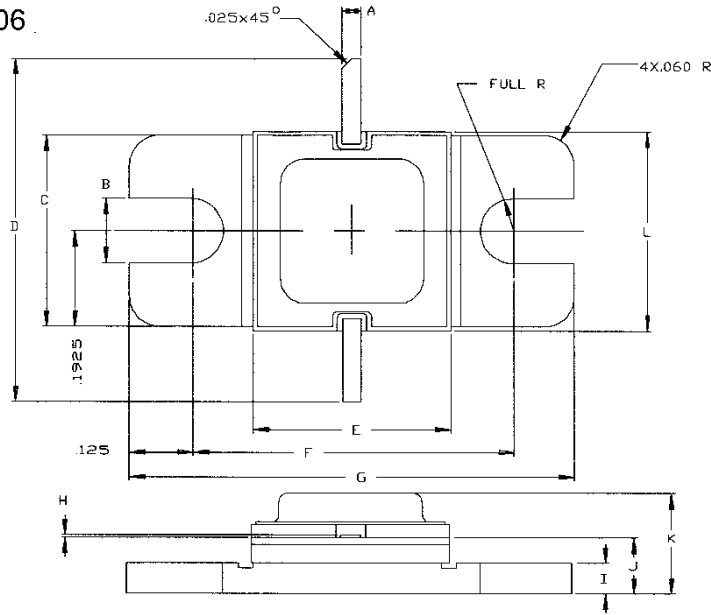

ADVANCED POWER TECHNOLOGY		CONT'D			
	MINIMUM Inches/mm	MAXIMUM Inches/mm		MINIMUM Inches/mm	MAXIMUM Inches/mm
A	.045/1,14	.055/1,40	K		.230/5,84
B	.125/3,18		L	.392/9,96	.402/10,29
C	.380/9,65	.390/9,91			
D	.710/18,03				
E	.392/9,96	.402/10,29			
F	.645/16,38	.655/16,64			
G	.895/22,73	.905/22,99			
H	.002/0,05	.006/0,15			
I	.055/1,40	.065/1,65			
J	.105/2,67	.125/3,18			