

54ABT/74ABT244

Octal Buffer/Line Driver with TRI-STATE® Outputs

General Description

The 'ABT244 is an octal buffer and line driver with TRI-STATE outputs designed to be employed as a memory and address driver, clock driver, or bus-oriented transmitter/receiver.

Features

- Non-inverting buffers
- Output sink capability of 64 mA, source capability of 32 mA
- Guaranteed output skew
- Guaranteed multiple output switching specifications
- Output switching specified for both 50 pF and 250 pF loads
- Guaranteed simultaneous switching, noise level and dynamic threshold performance
- Guaranteed latchup protection
- High impedance glitch free bus loading during entire power up and power down cycle
- Nondestructive hot insertion capability
- Disable time less than enable time to avoid bus contention
- Standard Military Drawing (SMD) 5962-9214701

Ordering Code: See Section 10

Commercial	Military	Package Number	Package Description
74ABT244CSC (Note 1)		M20B	20-Lead (0.300" Wide) Molded Small Outline, JEDEC
74ABT244CSJ (Note 1)		M20D	20-Lead (0.300" Wide) Molded Small Outline, EIAJ
74ABT244CPC		N20B	20-Lead (0.300" Wide) Molded Dual-In-Line
	54ABT244J/883	J20A	20-Lead Ceramic Dual-In-Line
74ABT244CMSA (Note 1)		MSA20	20-Lead Molded Shrink Small Outline, EIAJ Type II
74ABT244CMT (Note 1)		MTC20	20-Lead Molded Thin Shrink Small Outline, JEDEC
	54ABT244W/883	W20A	20-Lead Cerpack
	54ABT244E/883	E20A	20-Lead Ceramic Leadless Chip Carrier, Type C

Note 1: Devices also available in 13" reel. Use suffix = SCX, SJX, MTCX and MSAX.

Connection Diagrams

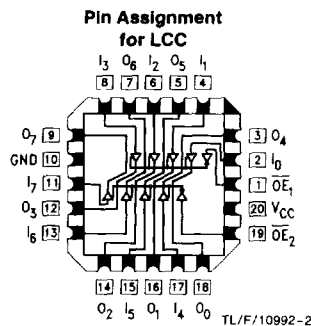
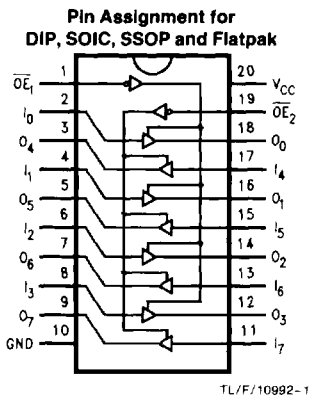

Truth Table

\overline{OE}_1	I_{0-3}	O_{0-3}	\overline{OE}_2	I_{4-7}	O_{4-7}
H	X	Z	H	X	Z
L	H	H	L	H	H
L	L	L	L	L	L

H = HIGH Voltage Level
 L = LOW Voltage Level
 X = Immaterial
 Z = High Impedance

Pin Names	Description
$\overline{OE}_1, \overline{OE}_2$	Output Enable Input (Active Low)
I_0-I_7	Inputs
O_0-O_7	Outputs

Absolute Maximum Ratings (Note 1)

If Military/Aerospace specified devices are required, please contact the National Semiconductor Sales Office/Distributors for availability and specifications.

Storage Temperature	-65°C to +150°C
Ambient Temperature under Bias	-55°C to +125°C
Junction Temperature under Bias	
Ceramic	-55°C to +175°C
Plastic	-55°C to +150°C
V _{CC} Pin Potential to Ground Pin	-0.5V to +7.0V
Input Voltage (Note 2)	-0.5V to +7.0V
Input Current (Note 2)	-30 mA to +5.0 mA
Voltage Applied to Any Output in the Disabled or Power-Off State in the HIGH State	-0.5V to 5.5V -0.5V to V _{CC}
Current Applied to Output in LOW State (Max)	twice the rated I _{OL} (mA)

DC Latchup Source Current - 500 mA

Over Voltage Latchup (I/O) 10V

Note 1: Absolute maximum ratings are values beyond which the device may be damaged or have its useful life impaired. Functional operation under these conditions is not implied.

Note 2: Either voltage limit or current limit is sufficient to protect inputs.

Recommended Operating Conditions

Free Air Ambient Temperature	
Military	-55°C to +125°C
Commercial	-40°C to +85°C
Supply Voltage	
Military	+4.5V to +5.5V
Commercial	+4.5V to +5.5V
Minimum Input Edge Rate	($\Delta V/\Delta t$)
Data Input	50 mV/ns
Enable Input	20 mV/ns

DC Electrical Characteristics

Symbol	Parameter	ABT244			Units	V _{CC}	Conditions
		Min	Typ	Max			
V _{IH}	Input HIGH Voltage	2.0			V		Recognized HIGH Signal
V _{IL}	Input LOW Voltage			0.8	V		Recognized LOW Signal
V _{CD}	Input Clamp Diode Voltage			-1.2	V	Min	I _{IN} = -18 mA
V _{OH}	Output HIGH Voltage	54ABT/74ABT	2.5		V	Min	I _{OH} = -3 mA
		54ABT	2.0		V	Min	I _{OH} = -24 mA
		74ABT	2.0		V	Min	I _{OH} = -32 mA
V _{OL}	Output LOW Voltage	54ABT		0.55	V	Min	I _{OL} = 48 mA
		74ABT		0.55	V	Min	I _{OL} = 64 mA
I _{IH}	Input HIGH Current			5 5	μA	Max	V _{IN} = 2.7V (Note 2) V _{IN} = V _{CC}
I _{BVI}	Input HIGH Current Breakdown Test			7	μA	Max	V _{IN} = 7.0V
I _{IL}	Input LOW Current			-5 -5	μA	Max	V _{IN} = 0.5V (Note 2) V _{IN} = 0.0V
V _{ID}	Input Leakage Test	4.75			V	0.0	I _{ID} = 1.9 μA All Other Pins Grounded
I _{OZH}	Output Leakage Current			50	μA	0 - 5.5V	V _{OUT} = 2.7V; $\overline{OE}_n = 2.0V$
I _{OZL}	Output Leakage Current			-50	μA	0 - 5.5V	V _{OUT} = 0.5V; $\overline{OE}_n = 2.0V$
I _{OS}	Output Short-Circuit Current	-100		-275	mA	Max	V _{OUT} = 0.0V
I _{CEx}	Output High Leakage Current			50	μA	Max	V _{OUT} = V _{CC}
I _{ZZ}	Bus Drainage Test			100	μA	0.0	V _{OUT} = 5.5V; All Others GND
I _{CC} H	Power Supply Current			50	μA	Max	All Outputs HIGH
I _{CC} L	Power Supply Current			30	mA	Max	All Outputs LOW
I _{CC} Z	Power Supply Current			50	μA	Max	$\overline{OE}_n = V_{CC}$; All Others at V _{CC} or Ground
I _{CC} T	Additional I _{CC} /Input	Outputs Enabled		2.5	mA	Max	V _I = V _{CC} - 2.1V Enable Input V _I = V _{CC} - 2.1V Data Input V _I = V _{CC} - 2.1V All Others at V _{CC} or Ground
		Outputs TRI-STATE		2.5	mA		
		Outputs TRI-STATE		50	μA		
I _{CC} D	Dynamic I _{CC} (Note 2)	No Load		0.1	mA/ MHz	Max	Outputs Open $\overline{OE}_n = GND$, (Note 1) One Bit Toggling, 50% Duty Cycle

Note 1: For 8 bits toggling, I_{CCD} < 0.8 mA/MHz

Note 2: Guaranteed, but not tested.

DC Electrical Characteristics (SOIC package) (Continued)

Symbol	Parameter	Min	Typ	Max	Units	V _{CC}	Conditions C _L = 50 pF, R _L = 500Ω
V _{OLP}	Quiet Output Maximum Dynamic V _{OL}		0.5	0.8	V	5.0	T _A = 25°C (Note 1)
V _{OLV}	Quiet Output Minimum Dynamic V _{OL}	-1.3	-0.8		V	5.0	T _A = 25°C (Note 1)
V _{OHV}	Minimum High Level Dynamic Output Voltage	2.7	3.1		V	5.0	T _A = 25°C (Note 3)
V _{IHD}	Minimum High Level Dynamic Input Voltage	2.0	1.5		V	5.0	T _A = 25°C (Note 2)
V _{ILD}	Maximum Low Level Dynamic Input Voltage		1.1	0.8	V	5.0	T _A = 25°C (Note 2)

Note 1: Max number of outputs defined as (n). n - 1 data inputs are driven 0V to 3V. One output at LOW. Guaranteed, but not tested.

Note 2: Max number of data inputs (n) switching. n - 1 inputs switching 0V to 3V. Input-under-test switching: 3V to threshold (V_{ILD}), 0V to threshold (V_{IHD}). Guaranteed, but not tested.

Note 3: Max number of outputs defined as (n). n - 1 data inputs are driven 0V to 3V. One output HIGH. Guaranteed, but not tested.

AC Electrical Characteristics (SOIC and SSOP package): See Section 2

Symbol	Parameter	74ABT			54ABT		74ABT		Units	Fig. No.
		T _A = +25°C V _{CC} = +5V C _L = 50 pF			T _A = -55°C to +125°C V _{CC} = 4.5V-5.5V C _L = 50 pF		T _A = -40°C to +85°C V _{CC} = 4.5V-5.5V C _L = 50 pF			
		Min	Typ	Max	Min	Max	Min	Max		
t _{PLH}	Propagation Delay	1.0	2.5	3.6	1.0	5.3	1.0	3.6	ns	2-3, 5
t _{PHL}	Data to Outputs	1.0	2.3	3.6	1.0	5.0	1.0	3.6		
t _{PZH}	Output Enable	1.5	3.5	6.0	0.8	6.5	1.5	6.0	ns	2-4
t _{PZL}	Time	1.5	3.6	6.0	1.2	7.9	1.5	6.0		
t _{PHZ}	Output Disable	1.7	3.5	5.6	1.2	7.6	1.7	5.6	ns	2-4
t _{PLZ}	Time	1.7	3.3	5.6	1.0	7.9	1.7	5.6		

Extended AC Electrical Characteristics (SOIC package): See Section 2

Symbol	Parameter	74ABT			74ABT		74ABT		Units	Fig. No.
		-40°C to +85°C V _{CC} = 4.5V-5.5V C _L = 50 pF 8 Outputs Switching (Note 4)			T _A = -40°C to +85°C V _{CC} = 4.5V-5.5V C _L = 250 pF 1 Output Switching (Note 5)		T _A = -40°C to +85°C V _{CC} = 4.5V-5.5V C _L = 250 pF 8 Outputs Switching (Note 6)			
		Min	Typ	Max	Min	Max	Min	Max		
f _{toggle}	Max Toggle Frequency	100							MHz	
t _{PLH}	Propagation Delay	1.5		5.0	1.5	6.0	2.5	8.5	ns	2-3, 5
t _{PHL}	Data to Outputs	1.5		5.0	1.5	6.0	2.5	8.5		
t _{PZH}	Output Enable Time	1.5		6.5	2.5	7.5	2.5	10.0	ns	2-4
t _{PZL}	Time	1.5		6.5	2.5	7.5	2.5	12.0		
t _{PHZ}	Output Disable Time	1.0		5.6	(Note 7)		(Note 7)		ns	2-4
t _{PLZ}	Time	1.0		5.6						

Note 4: This specification is guaranteed but not tested. The limits apply to propagation delays for all paths described switching in phase (i.e., all low-to-high, high-to-low, etc.).

Note 5: This specification is guaranteed but not tested. The limits represent propagation delay with 250 pF load capacitors in place of the 50 pF load capacitors in the standard AC load. This specification pertains to single output switching only.

Note 6: This specification is guaranteed but not tested. The limits represent propagation delays for all paths described switching in phase (i.e., all low-to-high, high-to-low, etc.) with 250 pF load capacitors in place of the 50 pF load capacitors in the standard AC load.

Note 7: The TRI-STATE delays are dominated by the RC network (500Ω, 250 pF) on the output and have been excluded from the datasheet.

Skew: See Section 2 (SOIC package)

Symbol	Parameter	74ABT	74ABT	Units	Fig. No.
		$T_A = -40^{\circ}\text{C to } +85^{\circ}\text{C}$ $V_{CC} = 4.5\text{V} - 5.5\text{V}$ $C_L = 50\text{ pF}$ 8 Outputs Switching (Note 3)	$T_A = -40^{\circ}\text{C to } +85^{\circ}\text{C}$ $V_{CC} = 4.5\text{V} - 5.5\text{V}$ $C_L = 250\text{ pF}$ 8 Outputs Switching (Note 4)		
		Max	Max		
t_{OSHL} (Note 1)	Pin to Pin Skew HL Transitions	0.8	1.8	ns	2-13
t_{OSLH} (Note 1)	Pin to Pin Skew LH Transitions	0.8	1.8	ns	2-13
t_{ps} (Note 5)	Duty Cycle LH-HL Skew	1.0	2.5	ns	2-14
t_{OST} (Note 1)	Pin to Pin Skew LH/HL Transitions	1.0	2.5	ns	2-17
t_{pv} (Note 2)	Device to Device Skew LH/HL Transitions	1.5	3.0	ns	2-20

Note 1: Skew is defined as the absolute value of the difference between the actual propagation delays for any two separate outputs of the same device. The specification applies to any outputs switching HIGH to LOW (t_{OSHL}), LOW to HIGH (t_{OSLH}), or any combination switching LOW to HIGH and/or HIGH to LOW (t_{OST}). The specification is guaranteed but not tested.

Note 2: Propagation delay variation for a given set of conditions (i.e., temperature and V_{CC}) from device to device. This specification is guaranteed but not tested.

Note 3: This specification is guaranteed but not tested. The limits apply to propagation delays for all paths described switching in phase (i.e., all low-to-high, high-to-low, etc.)

Note 4: These specifications guaranteed but not tested. The limits represent propagation delays with 250 pF load capacitors in place of the 50 pF load capacitors in the standard AC load.

Note 5: This describes the difference between the delay of the Low-to-High and the High-to-Low transition on the same pin. It is measured across all the outputs (drivers) on the same chip, the worst (largest delta) number is the guaranteed specification. This specification is guaranteed but not tested.

Capacitance

Symbol	Parameter	Typ	Units	Conditions $T_A = 25^{\circ}\text{C}$
C_{IN}	Input Capacitance	5.0	pF	$V_{CC} = 0\text{V}$
C_{OUT} (Note 1)	Output Capacitance	9.0	pF	$V_{CC} = 5.0\text{V}$

Note 1: C_{OUT} is measured at frequency $f = 1\text{ MHz}$, per MIL-STD-883B, Method 3012.

t_{PLH} vs Temperature (T_A)
 $C_L = 50$ pF, 1 Output Switching

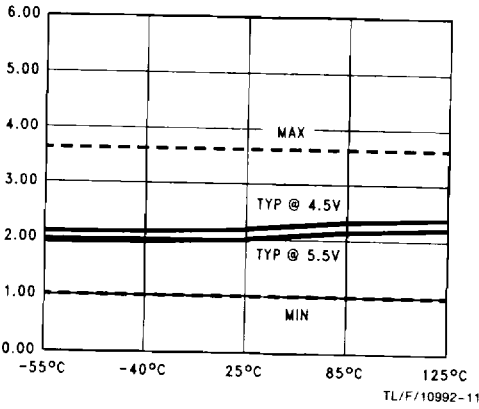

t_{PHL} vs Temperature (T_A)
 $C_L = 50$ pF, 1 Output Switching

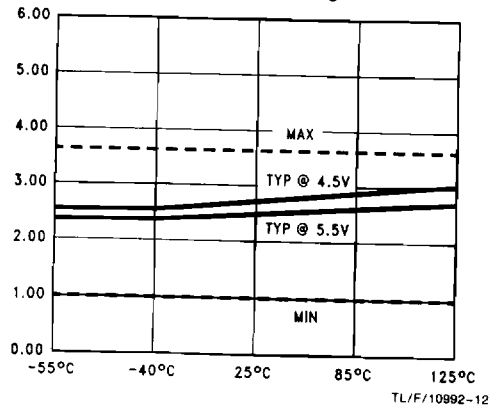

t_{PLH} vs Load Capacitance
 1 Output Switching, $T_A = 25^\circ\text{C}$

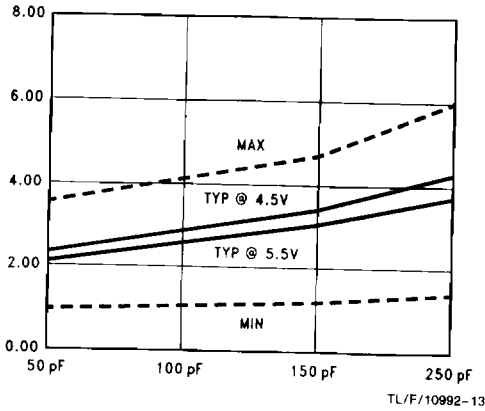

t_{PHL} vs Load Capacitance
 1 Output Switching, $T_A = 25^\circ\text{C}$

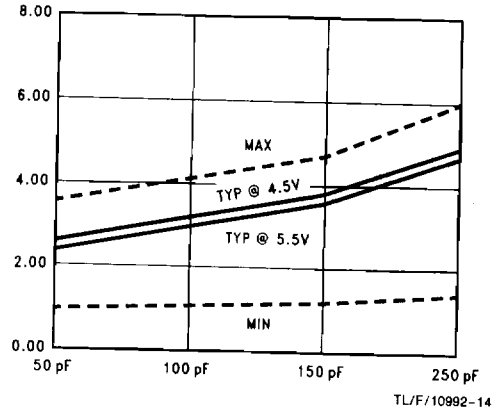

t_{PLH} vs Load Capacitance
 8 Outputs Switching, $T_A = 25^\circ\text{C}$

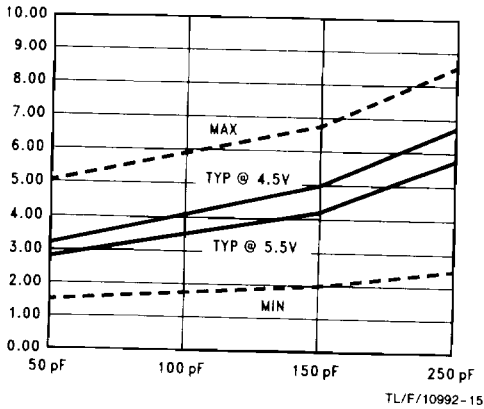

t_{PHL} vs Load Capacitance
 8 Outputs Switching, $T_A = 25^\circ\text{C}$

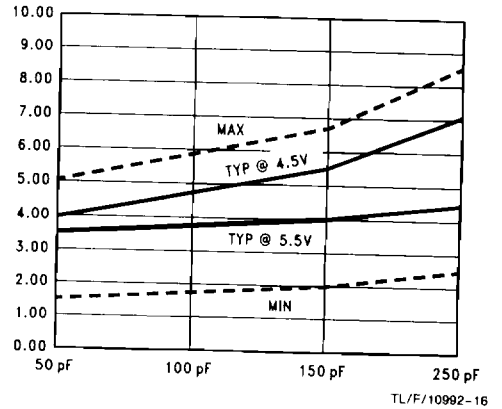

Dashed lines represent design characteristics; for specified guarantees refer to AC Characteristics Table.

tp_{ZL} vs Temperature (T_A)
C_L = 50 pF, 1 Output Switching

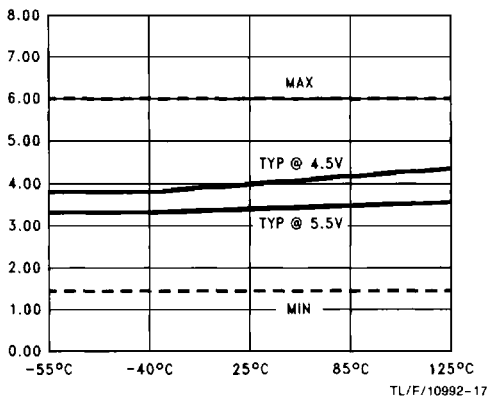

tp_{LZ} vs Temperature (T_A)
C_L = 50 pF, 1 Output Switching

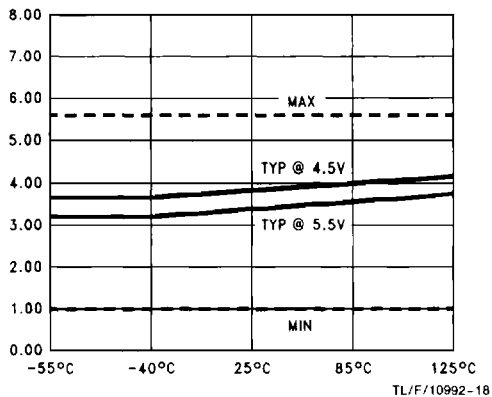

tp_{ZH} vs Temperature (T_A)
C_L = 50 pF, 1 Output Switching

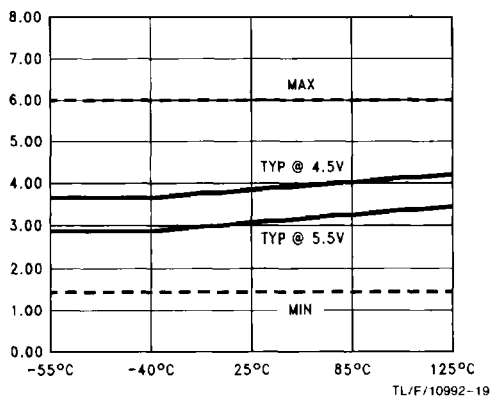

tp_{HZ} vs Temperature (T_A)
C_L = 50 pF, 1 Output Switching

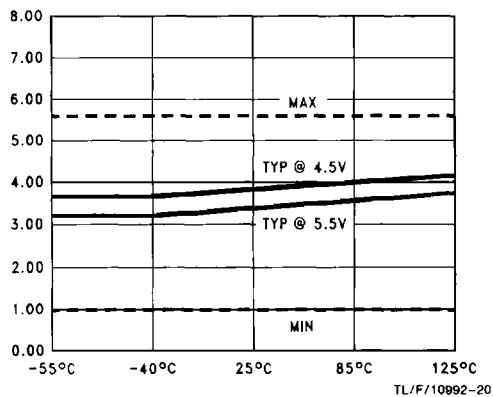

tp_{ZH} vs Temperature (T_A)
C_L = 50 pF, 8 Outputs Switching

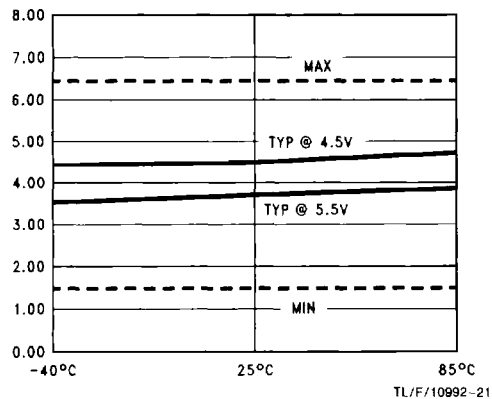

tp_{HZ} vs Temperature (T_A)
C_L = 50 pF, 8 Outputs Switching

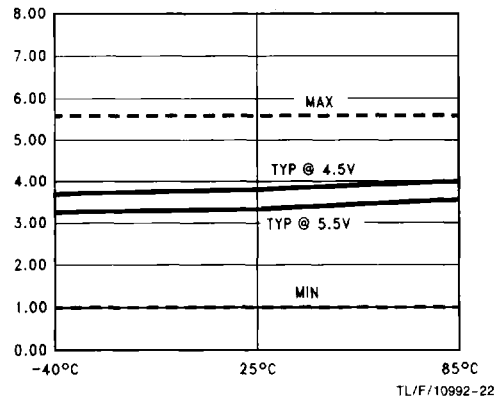

Dashed lines represent design characteristics; for specified guarantees refer to AC Characteristics Table.

tpZL vs Temperature (TA)
CL = 50 pF, 8 Outputs Switching

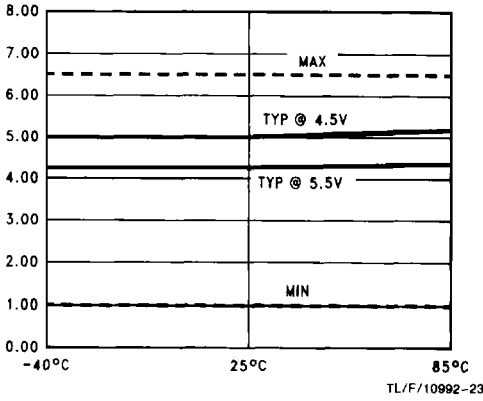

tpLZ vs Temperature (TA)
CL = 50 pF, 8 Outputs Switching

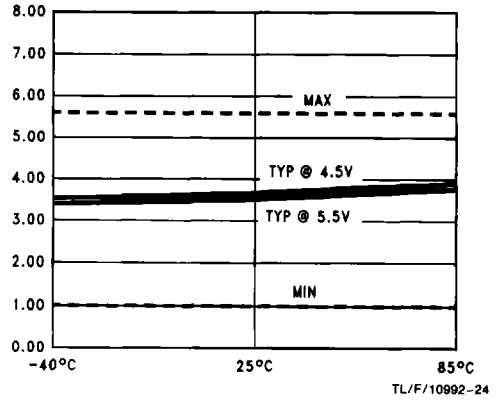

tpZL vs Load Capacitance
8 Outputs Switching
TA = 25°C

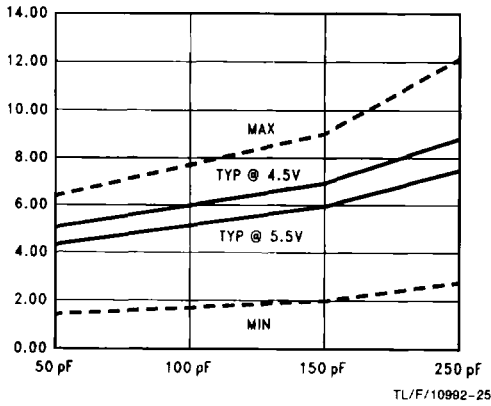

tpZH vs Load Capacitance
8 Outputs Switching
TA = 25°C

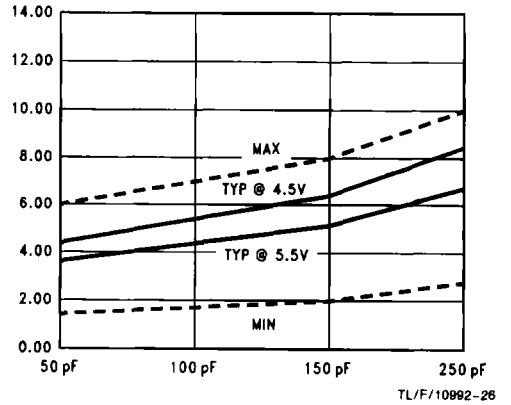

tPLH and tPHL vs Number
Outputs Switching VCC = 5.0V,
TA = 25°C, CL = 50 pF

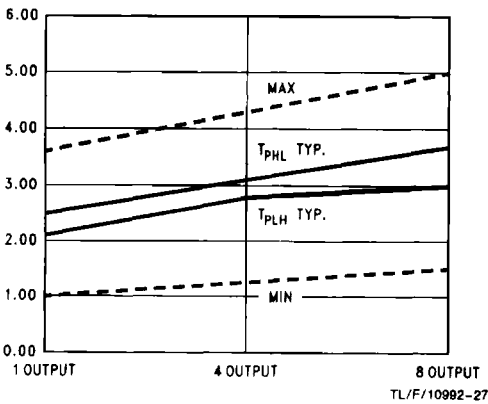

ICC vs Frequency,
Average, TA = 25°C,
All Outputs Unloaded/Unterminated

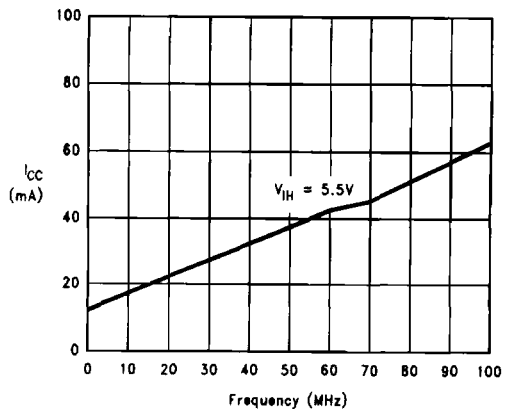

Dashed lines represent design characteristics; for specified guarantees refer to AC Characteristics Table.