

## +3.0V to +5.5V RS-232 Driver/Receiver Pair

- Meets True RS-232 Protocol Operation From A +3.0V to +5.5V Power Supply
- Minimum 120 Kbps Data Rate Under Full Load
- 1 $\mu$ A Low-Power Shutdown With Receivers Active
- Interoperable With RS-232 Down To +2.7V Power Source
- Pin-Compatible With The **MAX3221E** Device Without The *AUTO ON-LINE*<sup>®</sup> Feature
- ESD Specifications:  
+2kV Human Body Model

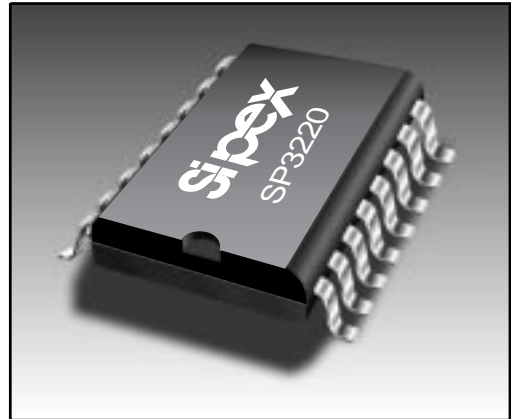

*Now Available in Lead Free Packaging*

### DESCRIPTION

The **SP3220** device is an RS-232 driver/receiver solution intended for portable or hand-held applications such as notebook or palmtop computers. The **SP3220** device has a high-efficiency, charge-pump power supply that requires only 0.1  $\mu$ F capacitors in 3.3V operation. This charge pump allows the **SP3220** device to deliver true RS-232 performance from a single power supply ranging from +3.3V to +5.0V.

The **SP3220** device has a low-power shutdown mode where the driver outputs and charge pumps are disabled. During shutdown, the supply current falls to less than 1  $\mu$ A.

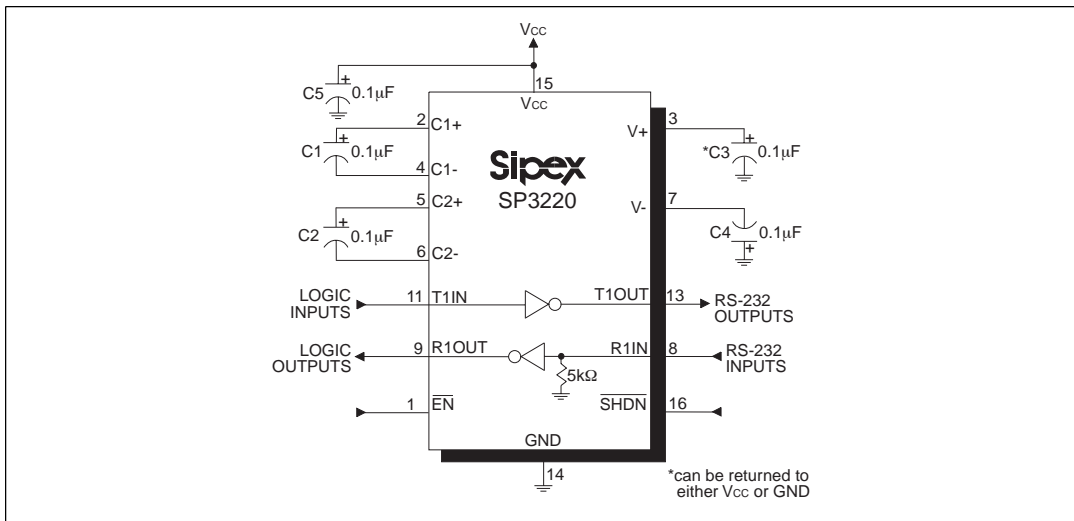

## ABSOLUTE MAXIMUM RATINGS

These are stress ratings only and functional operation of the device at these ratings or any other above those indicated in the operation sections of the specifications below is not implied. Exposure to absolute maximum rating conditions for extended periods of time may affect reliability and cause permanent damage to the device.

$V_{CC}$ .....	-0.3V to +6.0V
$V+$ (NOTE 1).....	-0.3V to +7.0V
$V-$ (NOTE 1).....	+0.3V to -7.0V
$V++ V- $ (NOTE 1).....	+13V
$I_{CC}$ (DC $V_{CC}$ or GND current).....	$\pm 100$ mA

**NOTE 1:**  $V+$  and  $V-$  can have maximum magnitudes of 7V, but their absolute difference cannot exceed 13V.

## Input Voltages

TxIN, EN .....	-0.3V to +6.0V
RxIN .....	$\pm 15$ V

## Output Voltages

TxOUT .....	$\pm 15.0$ V
RxOUT .....	-0.3V to +6.0V

## Short-Circuit Duration

TxOUT .....	Continuous
-------------	------------

Storage Temperature .....	-65°C to +150°C
---------------------------	-----------------

## Power Dissipation Per Package

16-pin SSOP (derate 9.69mW/°C above +70°C) .....	775mW
16-pin TSSOP (derate 10.5mW/°C above +70°C) .....	840mW
16-pin Wide SOIC (derate 11.2mW/°C above +70°C) .....	900mW

## SPECIFICATIONS

Unless otherwise noted, the following specifications apply for  $V_{CC} = +3.0$ V to +5.0V with  $T_{AMB} = T_{MIN}$  to  $T_{MAX}$ . Typical Values apply at  $V_{CC} = +3.3$ V or +5.0V and  $T_{AMB} = 25^\circ$ C.

PARAMETER	MIN.	TYP.	MAX.	UNITS	CONDITIONS
DC CHARACTERISTICS					
Supply Current		0.3	1.0	mA	no load, $T_{AMB} = +25^\circ$ C, $V_{CC} = 3.3$ V
Shutdown Supply Current		1.0	10	$\mu$ A	$\overline{SHDN} = \text{GND}$ , $T_{AMB} = +25^\circ$ C, $V_{CC} = +3.3$ V
LOGIC INPUTS AND RECEIVER OUTPUTS					
Input Logic Threshold LOW			0.8	V	TxIN, $\overline{EN}$ , $\overline{SHDN}$ , Note 2
Input Logic Threshold HIGH	2.0 2.4			V	$V_{CC} = 3.3$ V, Note 2 $V_{CC} = 5.0$ V, Note 2
Input Leakage Current		$\pm 0.01$	$\pm 1.0$	$\mu$ A	TxIN, $\overline{EN}$ , $\overline{SHDN}$ , $T_{AMB} = +25^\circ$ C
Output Leakage Current		$\pm 0.05$	$\pm 10$	$\mu$ A	receivers disabled
Output Voltage LOW			0.4	V	$I_{OUT} = 1.6$ mA
Output Voltage HIGH	$V_{CC} - 0.6$	$V_{CC} - 0.1$		V	$I_{OUT} = -1.0$ mA
DRIVER OUTPUTS					
Output Voltage Swing	$\pm 5.0$	$\pm 5.4$		V	3k $\Omega$ load to ground at all driver outputs, $T_{AMB} = +25^\circ$ C
Output Resistance	300			$\Omega$	$V_{CC} = V+ = V- = 0$ V, $T_{OUT} = \pm 2$ V
Output Short-Circuit Current		$\pm 35$ $\pm 70$	$\pm 60$ $\pm 100$	mA mA	$V_{OUT} = 0$ V $V_{OUT} = \pm 15$ V
Output Leakage Current			$\pm 25$	$\mu$ A	$V_{OUT} = \pm 12$ V, $V_{CC} = 0$ V to 5.5V, drivers disabled

## SPECIFICATIONS (continued)

Unless otherwise noted, the following specifications apply for  $V_{CC} = +3.0V$  to  $+5.0V$  with  $T_{AMB} = T_{MIN}$  to  $T_{MAX}$ .  
 Typical Values apply at  $V_{CC} = +3.3V$  or  $+5.0V$  and  $T_{AMB} = 25^{\circ}C$ .

PARAMETER	MIN.	TYP.	MAX.	UNITS	CONDITIONS
RECEIVER INPUTS					
Input Voltage Range	-15		+15	V	
Input Threshold LOW	0.6 0.8	1.2 1.5		V	$V_{CC}=3.3V$ $V_{CC}=5.0V$
Input Threshold HIGH		1.5 1.8	2.4 2.4	V	$V_{CC}=3.3V$ $V_{CC}=5.0V$
Input Hysteresis		0.3		V	
Input Resistance	3	5	7	k $\Omega$	
TIMING CHARACTERISTICS					
Maximum Data Rate	120	235		kbps	$R_L=3k\Omega$ , $C_L=1000pF$ , one driver switching
Driver Propagation Delay		1.0 1.0		$\mu s$ $\mu s$	$t_{PHL}$ , $R_L = 3K\Omega$ , $C_L = 1000pF$ $t_{PLH}$ , $R_L = 3K\Omega$ , $C_L = 1000pF$
Receiver Propagation Delay		0.3 0.3		$\mu s$	$t_{PHL}$ , RxIN to RxOUT, $C_L=150pF$ $t_{PLH}$ , RxIN to RxOUT, $C_L=150pF$
Receiver Output Enable Time		200		ns	
Receiver Output Disable Time		200		ns	
Driver Skew		100	500	ns	$ t_{PHL} - t_{PLH} $ , $T_{AMB} = 25^{\circ}C$
Receiver Skew		200	1000	ns	$ t_{PHL} - t_{PLH} $
Transition-Region Slew Rate			30	V/ $\mu s$	$V_{CC} = 3.3V$ , $R_L = 3K\Omega$ , $T_{AMB} = 25^{\circ}C$ , measurements taken from $-3.0V$ to $+3.0V$ or $+3.0V$ to $-3.0V$

**NOTE 2:** Driver input hysteresis is typically 250mV.

## TYPICAL PERFORMANCE CHARACTERISTICS

Unless otherwise noted, the following performance characteristics apply for  $V_{CC} = +3.3V$ , 120kbps data rates, all drivers loaded with  $3k\Omega$ ,  $0.1\mu F$  charge pump capacitors, and  $T_{AMB} = +25^{\circ}C$ .

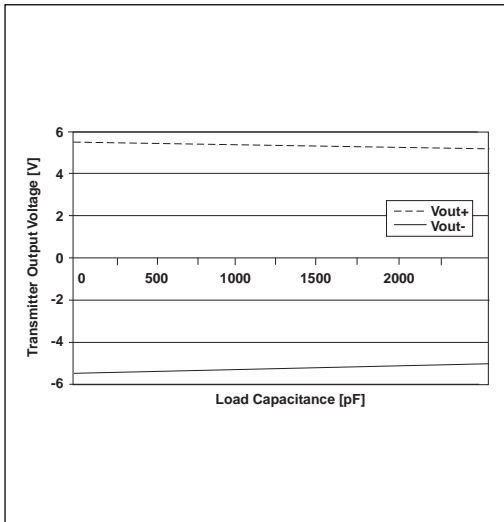

Figure 1. Transmitter Output Voltage VS. Load Capacitance for the SP3220

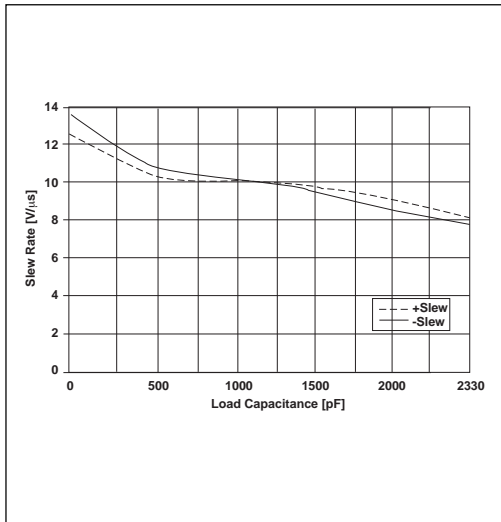

Figure 2. Slew Rate VS. Load Capacitance for the SP3220

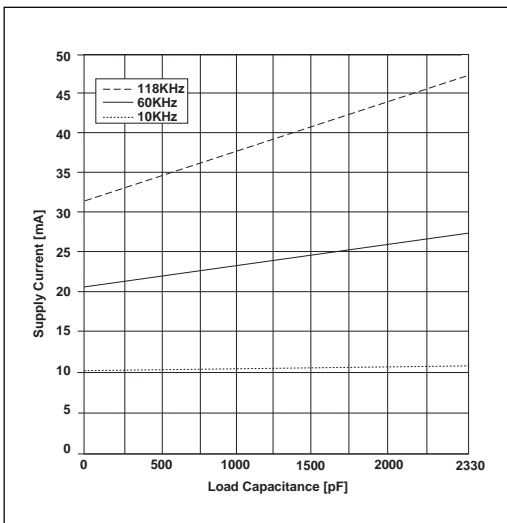

Figure 3. Supply Current VS. Load Capacitance when Transmitting Data for the SP3220

NAME	FUNCTION	PIN NUMBER
$\overline{\text{EN}}$	Receiver Enable Control. Drive LOW for normal operation. Drive HIGH to Tri-State the receiver outputs (high-Z state).	1
C1+	Positive terminal of the voltage doubler charge-pump capacitor.	2
V+	+5.5V generated by the charge pump.	3
C1-	Negative terminal of the voltage doubler charge-pump capacitor.	4
C2+	Positive terminal of the inverting charge-pump capacitor.	5
C2-	Negative terminal of the inverting charge-pump capacitor.	6
V-	-5.5V generated by the charge pump.	7
R1IN	RS-232 receiver input.	8
R1OUT	TTL/CMOS receiver output.	9
N.C.	No Connect.	10, 12
T1IN	TTL/CMOS driver input.	11
T1OUT	RS-232 driver output.	13
GND	Ground.	14
V <sub>cc</sub>	+3.0V to +5.5V supply voltage	15
$\overline{\text{SHDN}}$	Shutdown Control Input. Drive HIGH for normal device operation. Drive LOW to shutdown the drivers (high-Z output) and the on-board charge pump power supply.	16

**Table 1. Device Pin Description**

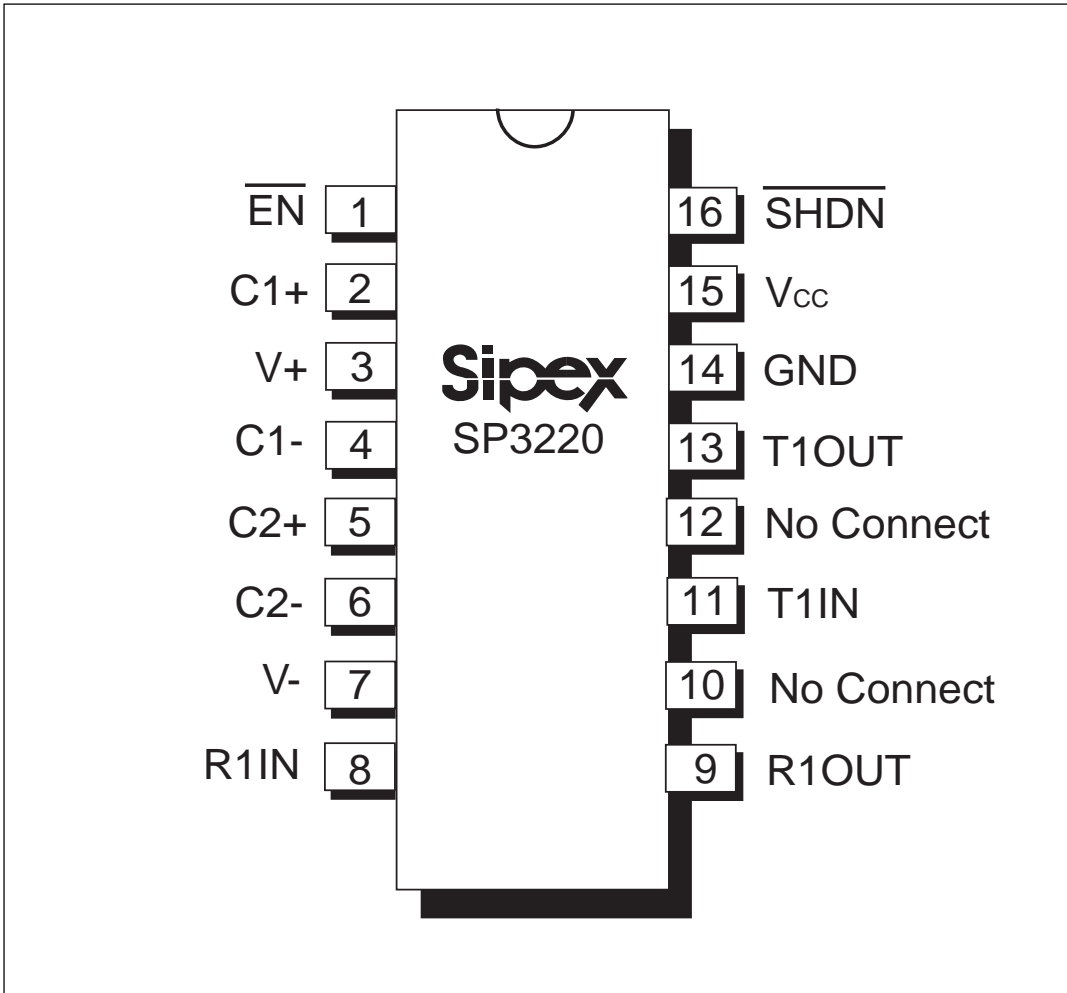

Figure 4. Pinout Configurations for the SP3220

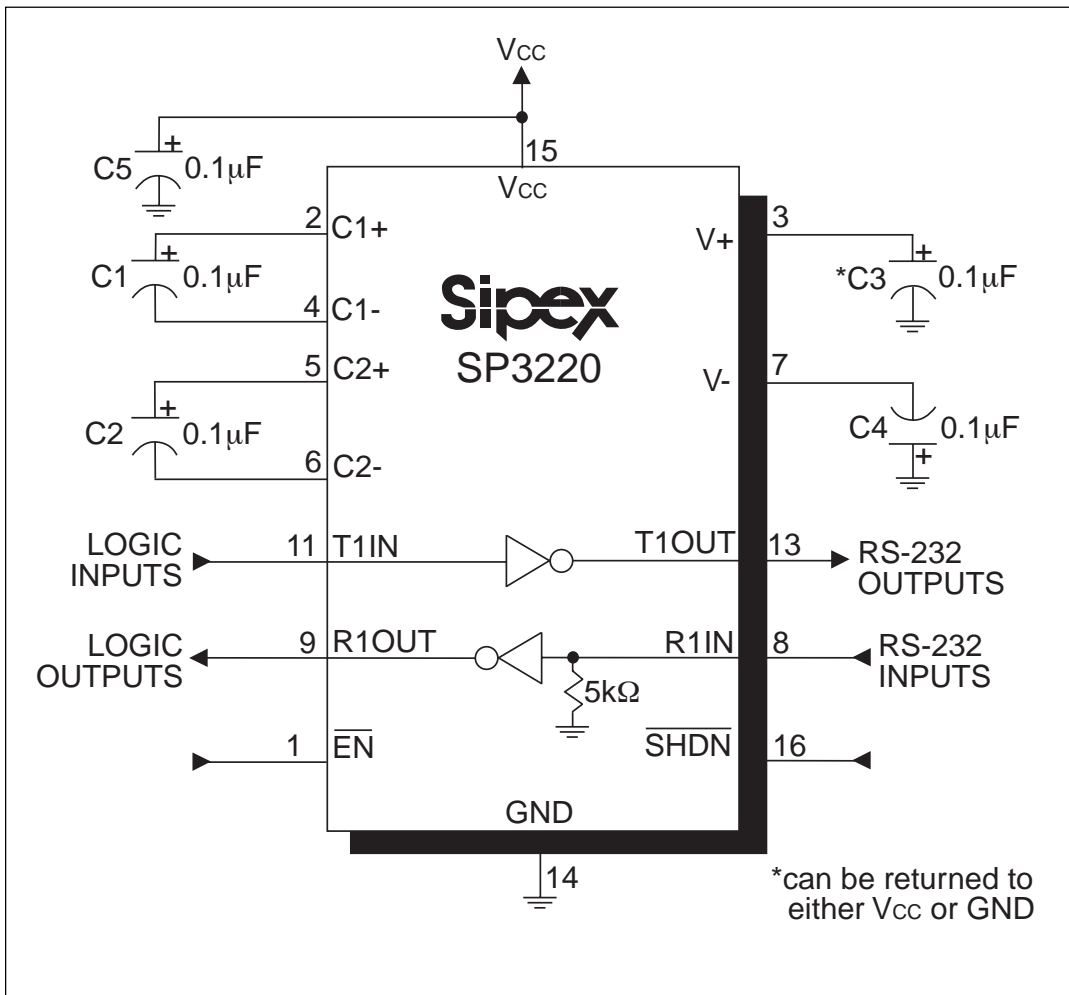

Figure 5. SP3220 Typical Operating Circuits

## DESCRIPTION

The **SP3220** device meets the EIA/TIA-232 and V.28/V.24 communication protocols and can be implemented in battery-powered, portable, or hand-held applications such as notebook or palmtop computers. The **SP3220** device features **Sipex's** proprietary on-board charge pump circuitry that generates  $2 \times V_{CC}$  for RS-232 voltage levels from a single +3.0V to +5.5V power supply. This series is ideal for +3.3V-only systems, mixed +3.0V to +5.5V systems, or +5.0V-only systems that require true RS-232 performance. The **SP3220** device has a driver that operates at a typical data rate of 235Kbps fully loaded.

The **SP3220** is a 1-driver/1-receiver device ideal for portable or hand-held applications. The **SP3220** features a  $1\mu\text{A}$  shutdown mode that reduces power consumption and extends battery life in portable systems. Its receivers remain active in shutdown mode, allowing external devices such as modems to be monitored using only  $1\mu\text{A}$  supply current.

## THEORY OF OPERATION

The **SP3220** device is made up of three basic circuit blocks: 1. Drivers, 2. Receivers, and 3. the Sipex proprietary charge pump.

### Drivers

The drivers are inverting level transmitters that convert TTL or CMOS logic levels to  $\pm 5.0\text{V}$  EIA/TIA-232 levels inverted relative to the input logic levels. Typically, the RS-232 output voltage swing is  $\pm 5.5\text{V}$  with no load and at least  $\pm 5\text{V}$  minimum fully loaded. The driver outputs are protected against infinite short-circuits to ground without degradation in reliability. Driver outputs will meet EIA/TIA-562 levels of  $\pm 3.7\text{V}$  with supply voltages as low as  $2.7\text{V}$ .

The drivers typically can operate at a data rate of 235Kbps. The drivers can guarantee a data rate of 120Kbps fully loaded with  $3\text{K}\Omega$  in parallel with  $1000\text{pF}$ , ensuring compatibility with PC-to-PC communication software.

The slew rate of the driver output is internally limited to a maximum of  $30\text{V}/\mu\text{s}$  in order to meet the EIA standards (EIA RS-232D 2.1.7, Paragraph 5). The transition of the loaded output from HIGH to LOW also meets the monotonicity requirements of the standard.

The **SP3220** driver can maintain high data rates up to 235Kbps fully loaded. *Figure 6* shows a loopback test circuit used to test the RS-232 driver. *Figure 7* shows the test results of the loopback circuit with the driver active at 120Kbps with an RS-232 load in parallel with a  $1000\text{pF}$  capacitor. *Figure 8* shows the test results where the driver was active at 235Kbps and loaded with an RS-232 receiver in parallel with a  $1000\text{pF}$  capacitor. A solid RS-232 data transmission rate of 120Kbps provides compatibility with many designs in personal computer peripherals and LAN applications.

The **SP3220** driver's output stage is turned off (high-Z) when the device is in shutdown mode. When the power is off, the **SP3220** device permits the outputs to be driven up to  $\pm 12\text{V}$ . The driver's input does not have pull-up resistors. Designers should connect an unused input to  $V_{CC}$  or GND.

In the shutdown mode, the supply current falls to less than  $1\mu\text{A}$ , where  $\overline{\text{SHDN}} = \text{LOW}$ . When the **SP3220** device is shut down, the device's driver output is disabled (high-Z) and the charge pump is turned off with  $V+$  pulled down to  $V_{CC}$  and  $V-$  pulled to GND. The time required to exit shutdown is typically  $100\mu\text{s}$ . Connect  $\overline{\text{SHDN}}$  to  $V_{CC}$  if the shutdown mode is not used.  $\overline{\text{SHDN}}$  has no effect on RxOUT. Note that the driver is enabled only when the magnitude of  $V-$  exceeds approximately  $3\text{V}$ .



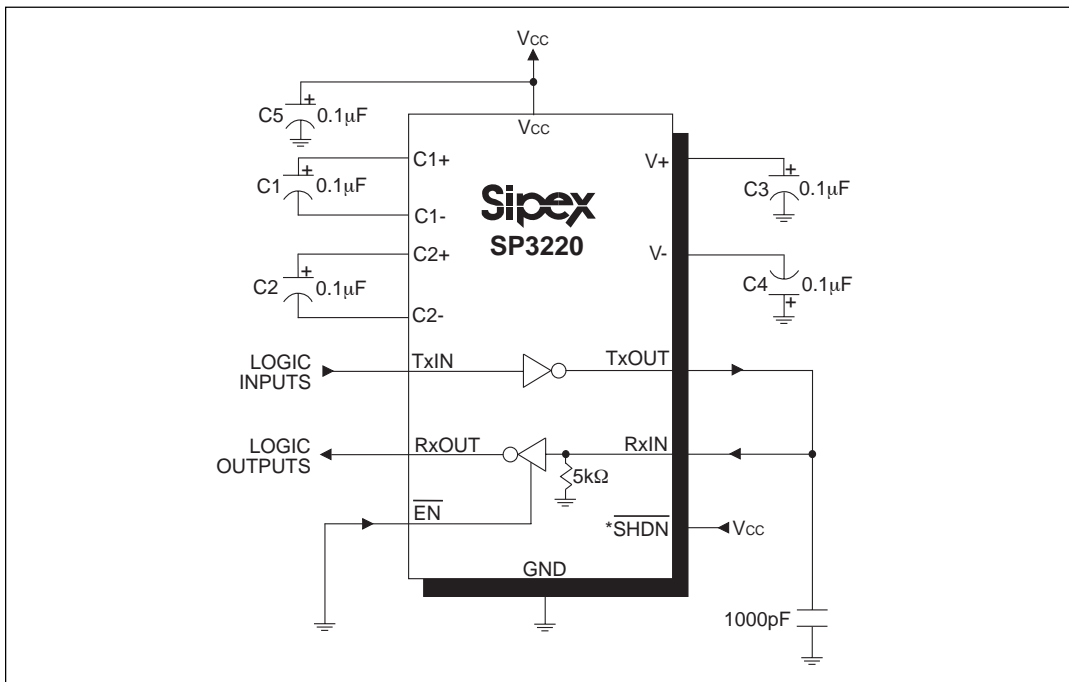

Figure 6. SP3220 Driver Loopback Test Circuit

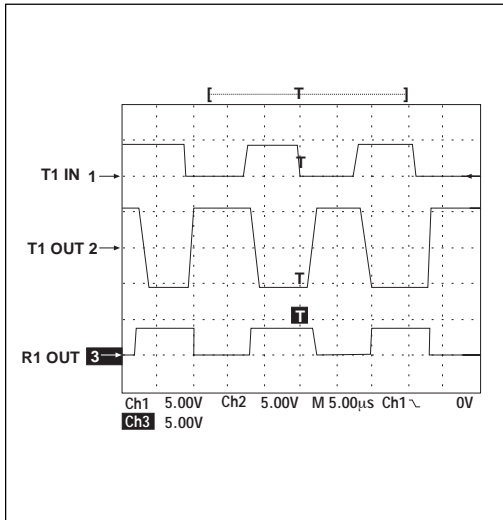

Figure 7. Driver Loopback Test Results at 120kbps

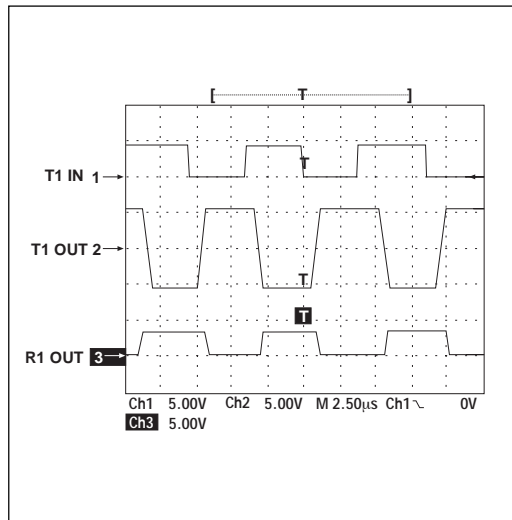

Figure 8. Driver Loopback Test Results at 235kbps

## Receivers

The receiver converts EIA/TIA-232 levels to TTL or CMOS logic output levels. The receiver has an inverting high-impedance output. This receiver output (RxOUT) is at high-impedance when the enable control  $\overline{\text{EN}} = \text{HIGH}$ . In the shutdown mode, the receiver can be active or inactive.  $\overline{\text{EN}}$  has no effect on TxOUT. The truth table logic of the **SP3220** driver and receiver outputs can be found in *Table 2*.

Since receiver input is usually from a transmission line where long cable lengths and system interference can degrade the signal, the inputs have a typical hysteresis margin of 300mV. This ensures that the receiver is virtually immune to noisy transmission lines. Should an input be left unconnected, a 5k $\Omega$  pulldown resistor to ground will commit the output of the receiver to a HIGH state.

## Charge Pump

The charge pump is a **Sipex**-patented design (U.S. 5,306,954) and uses a unique approach compared to older less-efficient designs. The charge pump still requires four external capacitors, but uses a four-phase voltage shifting technique to attain symmetrical 5.5V power supplies. The internal power supply consists of a regulated dual charge pump that provides output voltages 5.5V regardless of the input voltage ( $V_{\text{CC}}$ ) over the +3.0V to +5.5V range.

$\overline{\text{SHDN}}$	$\overline{\text{EN}}$	TxOUT	RxOUT
0	0	Tri-state	Active
0	1	Tri-state	Tri-state
1	0	Active	Active
1	1	Active	Tri-state

*Table 2. Truth Table Logic for Shutdown and Enable Control*

In most circumstances, decoupling the power supply can be achieved adequately using a 0.1 $\mu\text{F}$  bypass capacitor at C5 (refer to *Figures 5*). In applications that are sensitive to power-supply noise, decouple  $V_{\text{CC}}$  to ground with a capacitor of the same value as charge-pump capacitor C1. Physically connect bypass capacitors as close to the IC as possible.

The charge pumps operate in a discontinuous mode using an internal oscillator. If the output voltages are less than a magnitude of 5.5V, the charge pumps are enabled. If the output voltage exceed a magnitude of 5.5V, the charge pumps are disabled. This oscillator controls the four phases of the voltage shifting. A description of each phase follows.

### Phase 1

—  $V_{\text{SS}}$  charge storage — During this phase of the clock cycle, the positive side of capacitors  $C_1$  and  $C_2$  are initially charged to  $V_{\text{CC}}$ .  $C_1^+$  is then switched to GND and the charge in  $C_1^-$  is transferred to  $C_2^-$ . Since  $C_2^+$  is connected to  $V_{\text{CC}}$ , the voltage potential across capacitor  $C_2$  is now 2 times  $V_{\text{CC}}$ .

### Phase 2

—  $V_{\text{SS}}$  transfer — Phase two of the clock connects the negative terminal of  $C_2$  to the  $V_{\text{SS}}$  storage capacitor and the positive terminal of  $C_2$  to GND. This transfers a negative generated voltage to  $C_3$ . This generated voltage is regulated to a minimum voltage of -5.5V. Simultaneous with the transfer of the voltage to  $C_3$ , the positive side of capacitor  $C_1$  is switched to  $V_{\text{CC}}$  and the negative side is connected to GND.

### Phase 3

—  $V_{\text{DD}}$  charge storage — The third phase of the clock is identical to the first phase — the charge transferred in  $C_1$  produces  $-V_{\text{CC}}$  in the negative terminal of  $C_1$ , which is applied to the negative side of capacitor  $C_2$ . Since  $C_2^+$  is at  $V_{\text{CC}}$ , the voltage potential across  $C_2$  is 2 times  $V_{\text{CC}}$ .

## Phase 4

—  $V_{DD}$  transfer — The fourth phase of the clock connects the negative terminal of  $C_2$  to GND, and transfers this positive generated voltage across  $C_2$  to  $C_4$ , the  $V_{DD}$  storage capacitor. This voltage is regulated to +5.5V. At this voltage, the internal oscillator is disabled. Simultaneous with the transfer of the voltage to  $C_4$ , the positive side of capacitor  $C_1$  is switched to  $V_{CC}$  and the negative side is connected to GND, allowing the charge pump cycle to begin again. The charge pump cycle will continue as long as the operational conditions for the internal oscillator are present.

Since both  $V^+$  and  $V^-$  are separately generated from  $V_{CC}$ ; in a no-load condition  $V^+$  and  $V^-$  will be symmetrical. Older charge pump approaches that generate  $V^-$  from  $V^+$  will show a decrease in the magnitude of  $V^-$  compared to  $V^+$  due to the inherent inefficiencies in the design.

The clock rate for the charge pump typically operates at 250kHz. The external capacitors can be as low as 0.1 $\mu$ F with a 16V breakdown voltage rating.

## ESD Tolerance

The **SP3220** device incorporates ruggedized ESD cells on all driver output and receiver input pins. The ESD structure is improved over our previous family for more rugged applications and environments sensitive to electro-static discharges and associated transients.

The Human Body Model has been the generally accepted ESD testing method for semiconductors. This method is also specified in MIL-STD-883, Method 3015.7 for ESD testing. The premise of this ESD test is to simulate the human body's potential to store electro-static energy and discharge it to an integrated circuit. The simulation is performed by using a test model as shown in *Figure 14*. This method will test the IC's capability to withstand an ESD transient during normal handling such as in manufacturing areas where the ICs tend to be handled frequently.

For the Human Body Model, the current limiting resistor ( $R_s$ ) and the source capacitor ( $C_s$ ) are 1.5k $\Omega$  and 100pF, respectively.

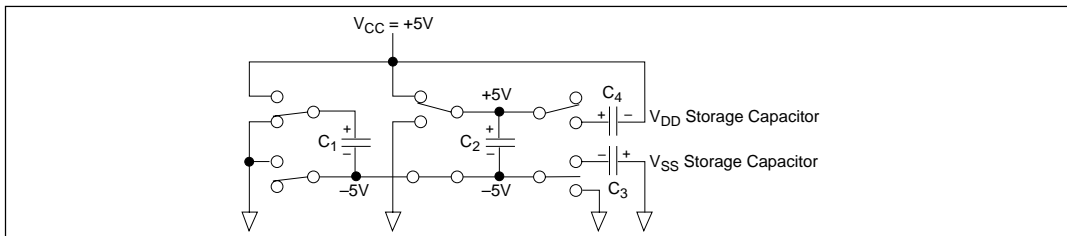

Figure 9. Charge Pump — Phase 1

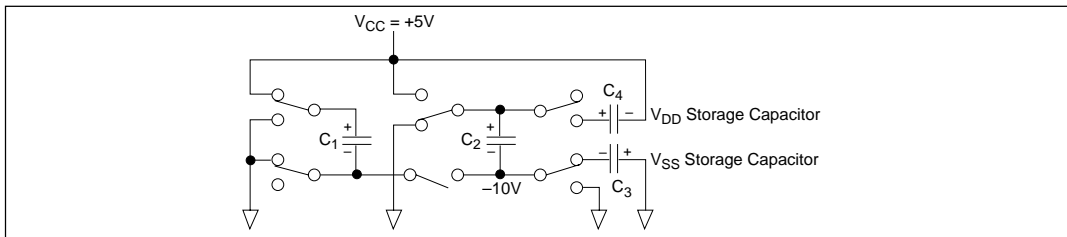

Figure 10. Charge Pump — Phase 2

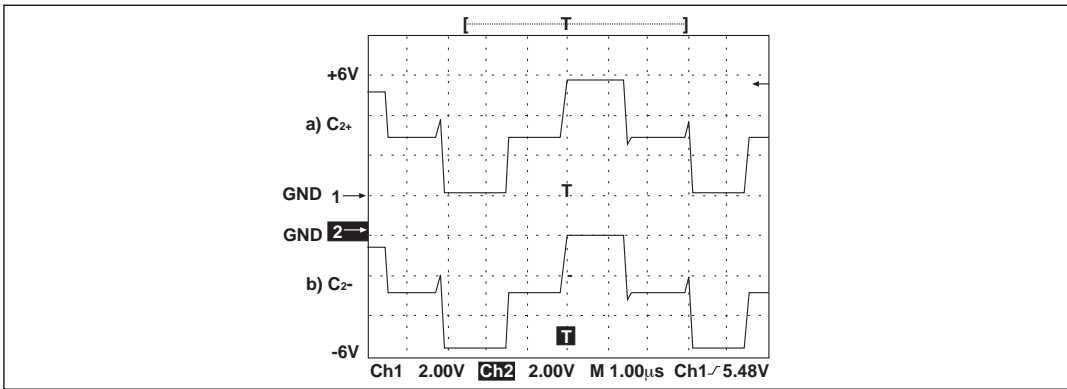

Figure 11. Charge Pump Waveforms

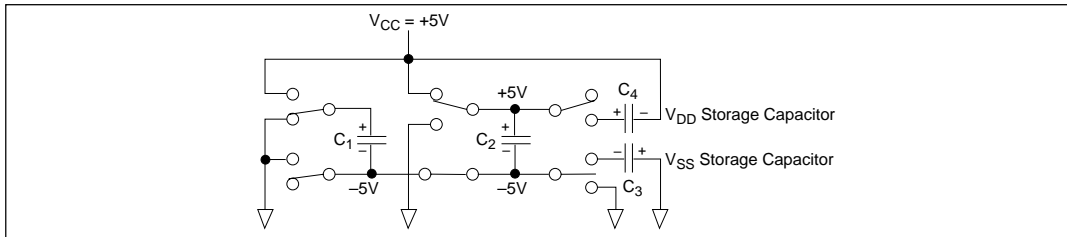

Figure 12. Charge Pump — Phase 3

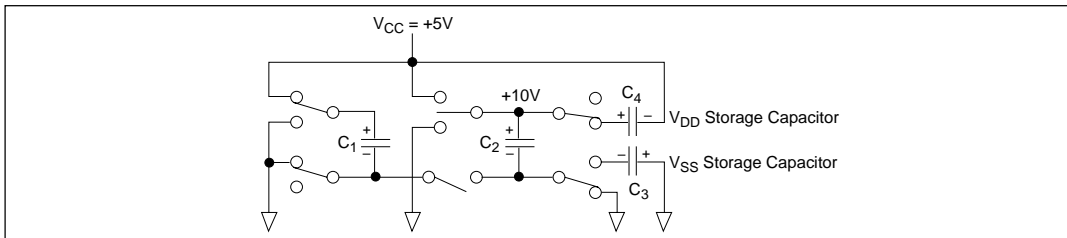

Figure 13. Charge Pump — Phase 4

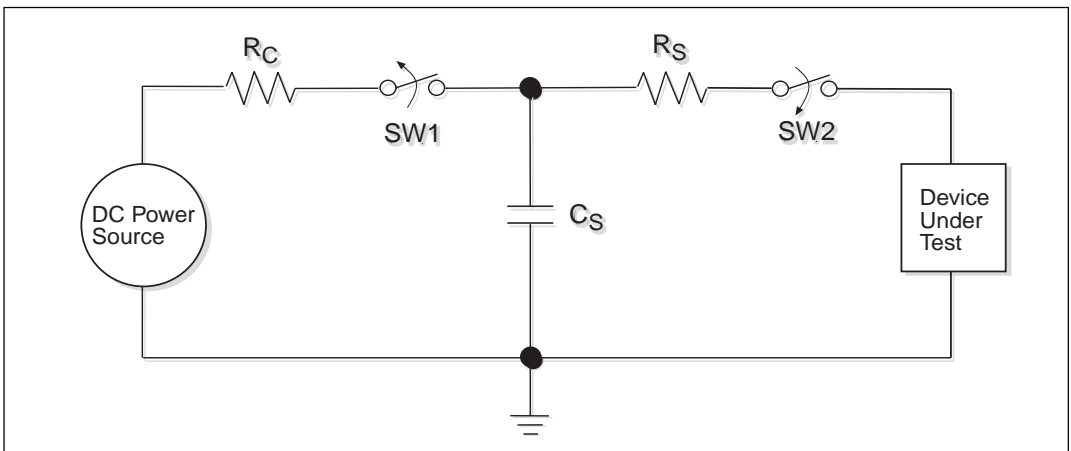
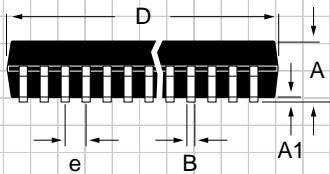
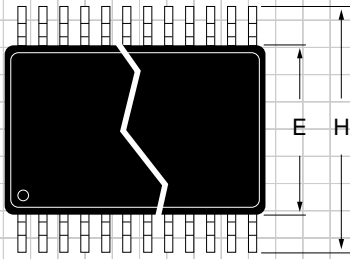

Figure 14. ESD Test Circuit for Human Body Model

**PACKAGE: PLASTIC SHRINK  
SMALL OUTLINE  
(SSOP)**



DIMENSIONS (Inches) Minimum/Maximum (mm)	16-PIN	20-PIN	24-PIN	28-PIN
A	0.068/0.078 (1.73/1.99)	0.068/0.078 (1.73/1.99)	0.068/0.078 (1.73/1.99)	0.068/0.078 (1.73/1.99)
A1	0.002/0.008 (0.05/0.21)	0.002/0.008 (0.05/0.21)	0.002/0.008 (0.05/0.21)	0.002/0.008 (0.05/0.21)
B	0.010/0.015 (0.25/0.38)	0.010/0.015 (0.25/0.38)	0.010/0.015 (0.25/0.38)	0.010/0.015 (0.25/0.38)
D	0.239/0.249 (6.07/6.33)	0.278/0.289 (7.07/7.33)	0.317/0.328 (8.07/8.33)	0.397/0.407 (10.07/10.33)
E	0.205/0.212 (5.20/5.38)	0.205/0.212 (5.20/5.38)	0.205/0.212 (5.20/5.38)	0.205/0.212 (5.20/5.38)
e	0.0256 BSC (0.65 BSC)	0.0256 BSC (0.65 BSC)	0.0256 BSC (0.65 BSC)	0.0256 BSC (0.65 BSC)
H	0.301/0.311 (7.65/7.90)	0.301/0.311 (7.65/7.90)	0.301/0.311 (7.65/7.90)	0.301/0.311 (7.65/7.90)
L	0.022/0.037 (0.55/0.95)	0.022/0.037 (0.55/0.95)	0.022/0.037 (0.55/0.95)	0.022/0.037 (0.55/0.95)
Ø	0°/8° (0°/8°)	0°/8° (0°/8°)	0°/8° (0°/8°)	0°/8° (0°/8°)

**PACKAGE: PLASTIC  
SMALL OUTLINE (SOIC)**

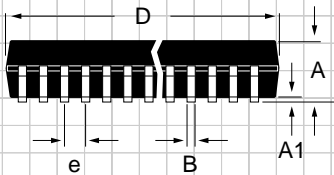
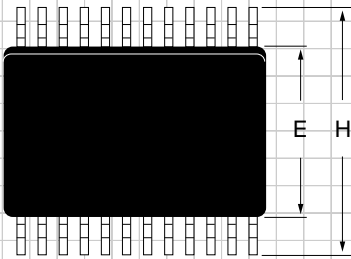

DIMENSIONS (Inches) Minimum/Maximum (mm)	16-PIN	18-PIN
A	0.090/0.104 (2.29/2.649)	0.090/0.104 (2.29/2.649)
A1	0.004/0.012 (0.102/0.300)	0.004/0.012 (0.102/0.300)
B	0.013/0.020 (0.330/0.508)	0.013/0.020 (0.330/0.508)
D	0.398/0.413 (10.10/10.49)	0.447/0.463 (11.35/11.74)
E	0.291/0.299 (7.402/7.600)	0.291/0.299 (7.402/7.600)
e	0.050 BSC (1.270 BSC)	0.050 BSC (1.270 BSC)
H	0.394/0.419 (10.00/10.64)	0.394/0.419 (10.00/10.64)
L	0.016/0.050 (0.406/1.270)	0.016/0.050 (0.406/1.270)
Ø	0°/8° (0°/8°)	0°/8° (0°/8°)

# PACKAGE: PLASTIC THIN SMALL OUTLINE (TSSOP)

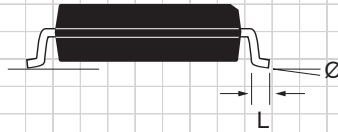
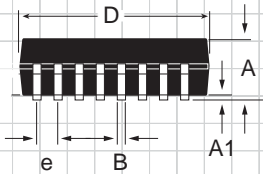
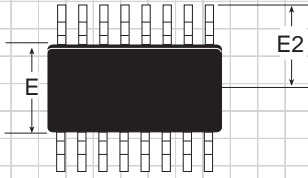

DIMENSIONS in inches (mm) Minimum/Maximum	16-PIN	20-PIN
A	-.0043 (-.1.10)	-.0043 (-.1.10)
A1	0.002/0.006 (0.05/0.15)	0.002/0.006 (0.05/0.15)
B	0.007/0.012 (0.19/0.30)	0.007/0.012 (0.19/0.30)
D	0.193/0.201 (4.90/5.10)	0.252/0.260 (6.40/6.60)
E	0.169/0.177 (4.30/4.50)	0.169/0.177 (4.30/4.50)
e	0.026 BSC (0.65 BSC)	0.026 BSC (0.65 BSC)
E2	0.126 BSC (3.20 BSC)	0.126 BSC (3.20 BSC)
L	0.020/0.030 (0.50/0.75)	0.020/0.030 (0.50/0.75)
Ø	0°/8°	0°/8°

## ORDERING INFORMATION

Model	Temperature Range	Package Type
SP3220CA .....	0°C to +70°C .....	16-Pin SSOP
SP3220CT .....	0°C to +70°C .....	16-Pin Wide SOIC
SP3220CY .....	0°C to +70°C .....	16-Pin TSSOP
SP3220EA .....	-40°C to +85°C .....	16-Pin SSOP
SP3220ET .....	-40°C to +85°C .....	16-Pin Wide SOIC
SP3220EY .....	-40°C to +85°C .....	16-Pin TSSOP

Available in lead free packaging. To order, add "-L" suffix to the part number.

Example: SP3220CA/TR=Tape & Reel. SP3220CA-L/TR = lead free.



ANALOG EXCELLENCE

### Sipex Corporation

#### Headquarters and Sales Office

233 South Hillview Drive  
Milpitas, CA 95035  
TEL: (408) 934-7500  
FAX: (408) 935-7600

#### Sales Office

22 Linnell Circle  
Billerica, MA 01821  
TEL: (978) 667-8700  
FAX: (978) 670-9001  
e-mail: sales@sipex.com

Sipex Corporation reserves the right to make changes to any products described herein. Sipex does not assume any liability arising out of the application or use of any product or circuit described herein; neither does it convey any license under its patent rights nor the rights of others.