

POWER MANAGEMENT

Description

The SC635 is a high-current charge pump designed specifically for use with white LEDs used in camera flash applications. Only two small bucket capacitors are required to develop the output drive, providing a low EMI solution compared to inductive boost regulators.

The SC635 has two modes of operation: Flash mode and Spotlight mode. In Flash mode, the SC635 is capable of delivering 200mA to a high-intensity LED during image capture. In Spotlight mode the SC635 outputs 40% of the Flash mode current for general purpose lighting or status indication.

An external resistor is connected in series with the LED to set the current. In Flash mode, this resistor can dissipate up to 50mW, reducing the power dissipation requirement of the SC635. The flash input (FLASH) overrides the control input (CTRL) to make sure the flash function is activated when called for.

The thermally efficient MLPD-10 package and ceramic bypass and bucket capacitors make the SC635 a high output current driver that requires minimal PCB area.

Features

- ◆ Two selectable modes - Flash and Spotlight
- ◆ 200mA max output - Flash Mode
- ◆ Spotlight mode set to 40% of Flash Current
- ◆ 3.0V to 5.25V Input Range
- ◆ External pins for control of flash and spotlight modes for synchronization to a camera module or graphics controller
- ◆ Short circuit, over-voltage, and over-temperature protection
- ◆ Soft-start functionality
- ◆ Micro Lead Package MLPD-10, 3mm x 3mm

Applications

- ◆ Mobile Camera Phones
- ◆ Digital Cameras
- ◆ PDAs with Built-in Cameras

Typical Application Circuit

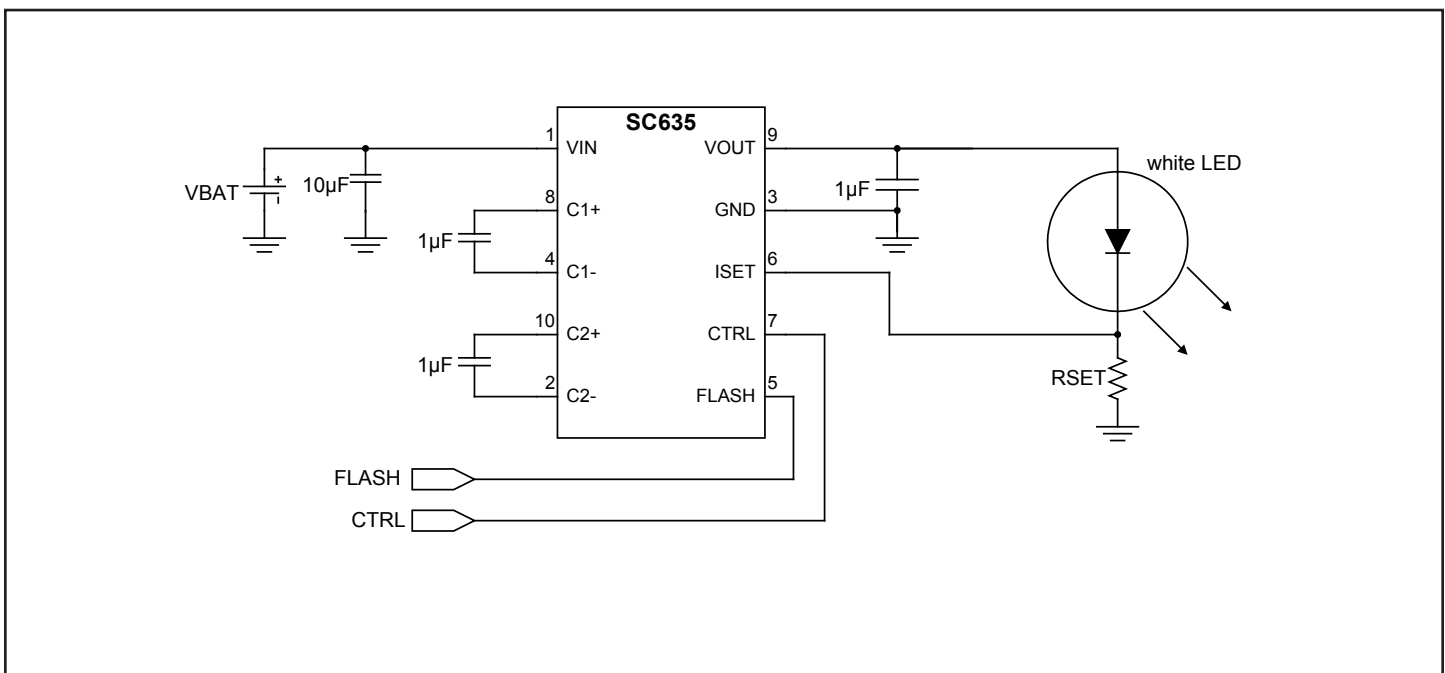

POWER MANAGEMENT
Absolute Maximum Ratings

Exceeding the specifications below may result in permanent damage to the device or device malfunction. Operation outside of the parameters specified in the Electrical Characteristics section is not implied.

Parameter	Symbol	Maximum	Units
Input Supply Voltage	V_{VIN}	-0.3 to +6.5	V
Output Voltage	V_{VOUT}	-0.3 to +6.5	V
Pin Voltage - FLASH, CTRL, ISET, C1-, C2-		-0.3 to $V_{VIN} + 0.3$	V
Pin Voltage - C1+, C2+		-0.3 to $V_{VOUT} + 0.3$	V
Thermal Resistance, Junction to Ambient (JEESD51 Standard Method) ⁽¹⁾	θ_{JA}	49	°C/W
VOUT Short Circuit Duration	SC	Indefinite	s
Operating Ambient Temperature Range	T_A	-40 to +85	°C
Junction Temperature Range	T_J	-40 to +150	°C
Storage Temperature Range	T_{STG}	-60 to +150	°C
Peak IR Flow Temperature	T_{LEAD}	260	°C
ESD Protection Level ⁽²⁾	V_{ESD}	2	kV

(1) Calculated from package in still air, mounted to 3" x 4.5", 4 layer FR4 PCB with thermal vias under the exposed pad as per JEESD51 standards.

(2) Tested according to JEDEC standard JEESD22-A114-B.

Electrical Characteristics

Unless otherwise specified: $T_A = 25^\circ\text{C}$ for TYP, -40°C to $+60^\circ\text{C}$ for MIN and MAX;

$C_{BUCKET} = C_{OUT} = 1.0\mu\text{F}$ (ESR < 0.1 Ω); $C_{IN} = 10.0\mu\text{F}$; $V_{VIN} = 3.0\text{V}$ to 5.25V ; $V_{VOUT} = 2.8\text{V}$ to 4.25V ; $R_{SET} = 0.5\Omega$ (0.1%).

Parameter	Symbol	Conditions	Min	Typ	Max	Units
Output Current	I_{OUT}	FLASH high, $R_{ISET} = 1.25\Omega$ $3.3\text{V} < V_{VIN} < 4.2\text{V}$ $2.8\text{V} < V_{VOUT} = 4.25\text{V}$	184	200	216	mA
		FLASH low, CTRL high, $R_{ISET} = 1.25\Omega$ $3.0\text{V} < V_{VIN} < 4.5\text{V}$ $2.8\text{V} < V_{VOUT} < 4.5\text{V}$	68	80	92	
ISET Reference Voltage	V_{ISET}	FLASH high, $R_{ISET} = 1.25\Omega$ $3.3\text{V} < V_{VIN} < 4.2\text{V}$ $2.8\text{V} < V_{VOUT} < 4.25\text{V}$	230	250	270	mV
		FLASH low, CTRL high, $R_{ISET} = 1.25\Omega$ $3.0\text{V} < V_{VIN} < 4.5\text{V}$ $2.8\text{V} < V_{VOUT} < 4.5\text{V}$	85	100	115	
Quiescent Current	I_Q	FLASH high		3.4	5.0	mA
		FLASH low, CTRL high		2.0	4.5	mA
		FLASH low, CTRL low		0.1	2.0	μA

POWER MANAGEMENT
Electrical Characteristics (Cont.)

Parameter	Symbol	Conditions	Min	Typ	Max	Units
Flash Mode Start-up Time ⁽¹⁾	t_{F-SU}	$t = 0$ when FLASH goes high to $I_{OUT} = 90\%$ of final value			1	ms
Flash Mode Pulse Duration	t_{FLASH}	$3.3V < V_{VIN} < 4.2V$ $I_{OUT} = 200mA, V_{VOUT} > 2.8V$	indefinite			s
Spotlight Mode Start-up Time ⁽¹⁾	t_{S-SU}	$t = 0$ when CTRL goes high to $I_{OUT} = 90\%$ of final value			1	ms
Oscillator Frequency	f_{OSC}	Device enabled		250		kHz
Oscillator Frequency Accuracy	Δf_{OSC}		-15		15	%
Short-circuit Output Current Limit	I_{SC}	VOUT shorted to GND			465	mA
Input Current Limit	I_{LIMIT}	$3.3V < V_{VIN} < 4.2V$	1.0		2.1	A
Over-temperature Protection ⁽¹⁾	T_{OT}		150			°C
		Hysteresis	10			
Logic Input High Threshold	V_{IH}	FLASH, CTRL	1.5			V
Logic Input Low Threshold	V_{IL}	FLASH, CTRL			0.4	V
Logic Input High Current	I_{IH}	FLASH	1	20	35	μA
		CTRL	2	40	70	
Logic Input High Current	I_{IL}	FLASH, CTRL		0.1	2.0	μA
ISET Ripple Voltage ⁽¹⁾	$V_{ISET(P-P)}$	Spotlight mode - $I_{OUT} = 80mA$		25		mV
		FLASH mode - $I_{OUT} = 200mA$		100		

Notes:

(1) Guaranteed by design - not tested in production.

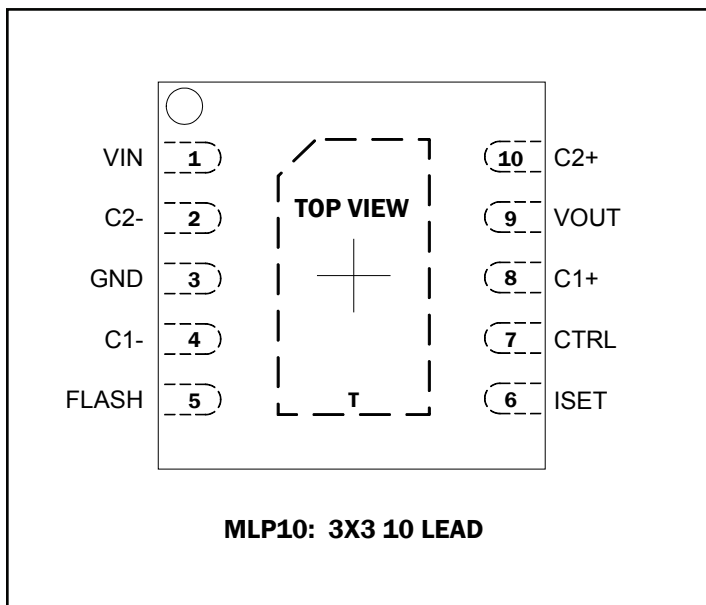
POWER MANAGEMENT
Pin Configuration

Ordering Information

DEVICE	PACKAGE
SC635MLTRT ⁽¹⁾⁽²⁾	MLPD-10 3x3
SC635EVB	Evaluation Board

Notes:

(1) Available in tape and reel only. A reel contains 3,000 devices.

(2) Available in lead-free package only. Device is WEEE and RoHS compliant.

Pin Descriptions

Pin#	Pin Name	Pin Function
1	VIN	Input voltage.
2	C2-	Negative terminal of bucket capacitor 2.
3	GND	Ground - connect to ground plane using multiple vias.
4	C1-	Negative terminal of bucket capacitor 1.
5	FLASH	Flash mode enable pin - puts the device in active Flash mode when high and also overrides CTRL.
6	ISET	Current-setting reference pin - connect to the LED cathode and the current setting resistor.
7	CTRL	Control input bit - used to enable and set the output current in Spotlight mode when high.
8	C1+	Positive terminal of bucket capacitor 1.
9	VOUT	Output pin.
10	C2+	Positive terminal of bucket capacitor 2.
T	Thermal Pad	Pad for heat sinking purposes - not connected internally. Connect to ground plane using multiple vias.

POWER MANAGEMENT**Applications Information****General Operation**

The SC635 is a powerful 2X charge pump designed to drive a high-intensity white LED with a constant current (Spotlight mode) or with a pulsed current of higher intensity (Flash mode) used for camera flash.

In Flash mode the SC635 output can drive 200mA at 4.25V into an LED for an unlimited duration under all temperature and input conditions. The FLASH pin is used to trigger this mode (active high). In Spotlight mode the SC635 regulates the output current to 40% of the Flash mode current setting when the CTRL pin is pulled high and the FLASH pin is low. Note that Flash mode has priority over Spotlight mode, i.e., the FLASH pin triggers Flash mode regardless of the state of the CTRL pin.

Output current is regulated by attaching the ISET pin to the cathode(s) of the LED package and a low resistance sense resistor (typically 1.25Ω). The ISET pin monitors the voltage at the cathode and signals the charge pump to increase or decrease the output current until the ISET voltage reaches the programmed setting. The resistor value is chosen to set the current through the LED based on this reference voltage.

Flash Mode

Flash mode is enabled whenever the FLASH pin is pulled high and remains active until the FLASH pin is released. This mode has higher priority than Spotlight mode, so the state of the CTRL pin is overridden whenever the FLASH pin is activated. While in Flash mode the reference voltage on the ISET pin is set to 250mV.

Output currents other than the rated maximum of 200mA can be set by changing the R_{ISET} value. In Flash mode, $I_{OUT} = 250\text{mV}/R_{ISET}$

Spotlight Mode

Spotlight mode is enabled by setting the CTRL pin high and keeping the FLASH pin low. When in Spotlight mode, the SC635 can maintain a constant current indefinitely to drive an LED or bank of LEDs. The ISET reference voltage is set to 100mV so that the output current is maintained at 80mA when a 1.25Ω resistor is used. Spotlight current is always 40% of flash current for any given value of R_{ISET} . In spotlight mode, $I_{OUT} = 100\text{mV}/R_{ISET}$. The resistor value should not exceed 2Ω, however, to ensure the SC635 does not become unstable while in Spotlight mode due to

the output current being set too low.

Protection Circuitry

The SC635 also provides protection circuitry that prevents the device from operating in an unspecified state. These functions include Input Over-Voltage Protection (IOVP), Output Over-Voltage Protection (OVP), Over-Temperature (OT) Protection, Over-Current Protection (OCP), and Short-Circuit Current Protection (SCCP).

Input Over-Voltage Protection

Input over-voltage protection is included to prevent operation at high input voltages that could damage the device. The IOVP circuit senses the input voltage and determines when the supply exceeds 6V. Hysteresis is included in this circuit to avoid chattering between states. When the voltage rises above this threshold, the device is disabled until the input voltage drops to a level within the specified range.

Output Over-Voltage Protection

Output over-voltage protection is included to prevent the SC635 from generating an output voltage that could damage other devices connected to it such as load LEDs and bypass capacitors. When the output voltage exceeds 5.5V, the OVP circuit disables the charge pump until the voltage decreases to a level within the acceptable range. This circuit allows the device to drive LEDs with high forward voltages at a reduced level without exceeding the output voltage limits specified for the device. Note, however, that this effect is a consequence of the OVP circuit and is not its intended purpose.

Over-Temperature Protection

The over-temperature circuit helps prevent the device from overheating and experiencing a catastrophic failure. When the junction temperature exceeds 150°C the device is disabled. It remains disabled until the junction temperature drops below this threshold. As with the UVLO and OVP circuits, hysteresis is included to prevent toggling between modes.

Over-Current Protection

When the SC635 is in 2X mode, the input current will be approximately double the required output. When the steady-state load requires the maximum current available in 2X mode, the OCP circuit prevents the device from overheating due to excessive power dissipation.

POWER MANAGEMENT**Applications Information (Cont.)****Short-Circuit Current Protection**

Short-circuit current protection is provided to limit the current that can be sourced when the output is shorted to ground. When a short circuit forces VOUT to drop below 2V, the SCCP detects the condition and limits the output current.

Resistor Selection

The ISET resistor selection is critical in generating the correct current. The value can be chosen to set the Spotlight mode current or the Flash mode current, but it must be noted that the two current settings are dependent on the same resistance. It is recommended that the resistor be selected to match the desired LED current for Flash mode. This allows the designer to set the SC635's maximum current and select the resistor package size necessary for the power dissipation required in Flash mode. The typical application shown on page 1 uses a 1.25Ω resistor to set a flash mode current of 200mA and spotlight mode current of 80mA. A high precision resistor should be used to ensure the specified accuracy for LED current.

To avoid malfunction of the charge pump, it is recommended that the resistance seen at the ISET pin remain constant while the device is active (Flash or Spotlight mode). Changing the resistance value or the load current while the device is active could cause instability that would result in non-compliant behavior.

The load current return path is from the ISET sense point through the resistor and back to the ground pins. Resistance in this path adds to the total resistance and has the effect of reducing the LED current by about 4% per 10mV

of DC drop across the return copper trace in flash mode. For this reason, it is crucial to have a low resistance return path. Place and ground the resistor as close as possible to the ground pin of the SC635. The trace from the ISET pin has virtually no current. The ISET trace should make contact at the pad of the power sense resistor to minimize the effect of voltage drop between the LED cathode and the resistor.

Capacitor Selection

The SC635 is designed to use low-ESR ceramic capacitors for the input and output bypass capacitors as well as the charge pump bucket capacitors. Ideal performance is achieved when C1 is exactly equal to C2. It is recommended that X5R or X7R ceramic capacitors be used for best performance.

Thermal Resistance

The SC635 package is thermally efficient when the circuit board layout connects the thermal pad through multiple vias to the ground plane. The thermal resistance is rated at 49°C/W, and this rating is dependent on the connection between the thermal pad and the ground plane. A layout that is done correctly should keep the junction temperature below the OT limit while operating the SC635 within the specified electrical conditions for IOOUT and V_{ISET} . A poor layout may allow the junction temperature to reach the OT limit while in Flash or Spotlight mode. It is critical to maintain adequate ground plane around the device to maximize heat transfer and avoid over-temperature shutdown.

POWER MANAGEMENT

Typical Characteristics

200mA Flash Duration, RISET = 1.25Ω, VOUT = 3.30V(start) to 3.25V(LED heated 500ms)

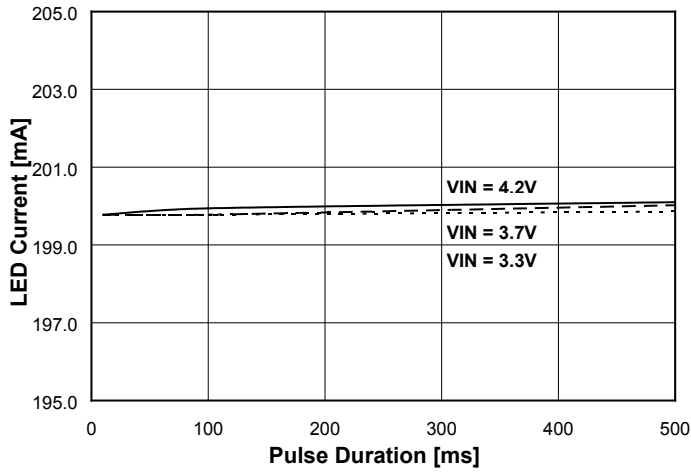

Flash Current at 500ms, RISET = 1.25Ω, VOUT = 3.25V

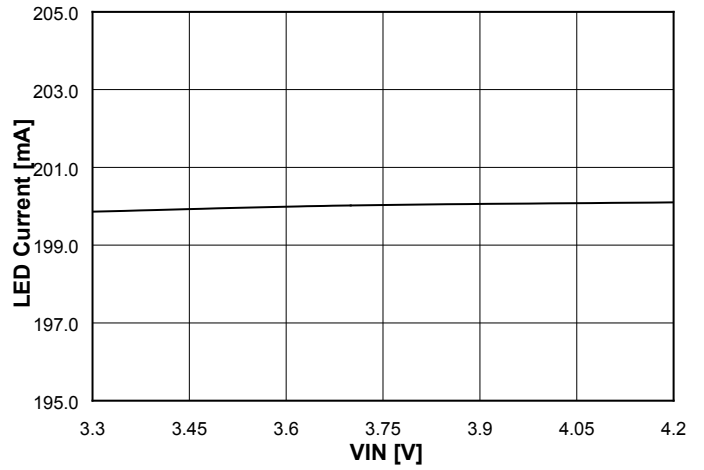

Flash Current at 100ms, RISET = 1.25Ω, VOUT = 3.28V

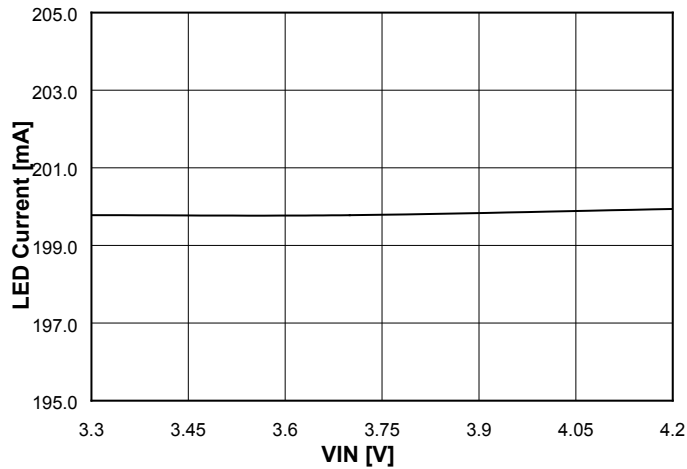

Flash Current at 10ms, RISET = 1.25Ω, VOUT = 3.30V

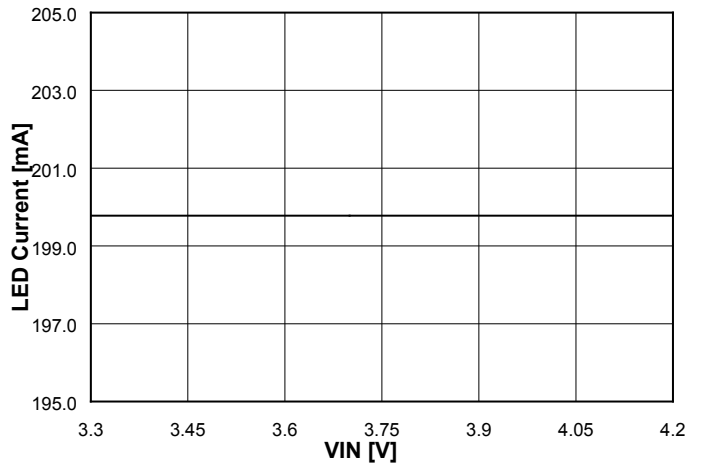

80mA Spotlight Current, RISET = 1.25Ω, VOUT = 2.96V

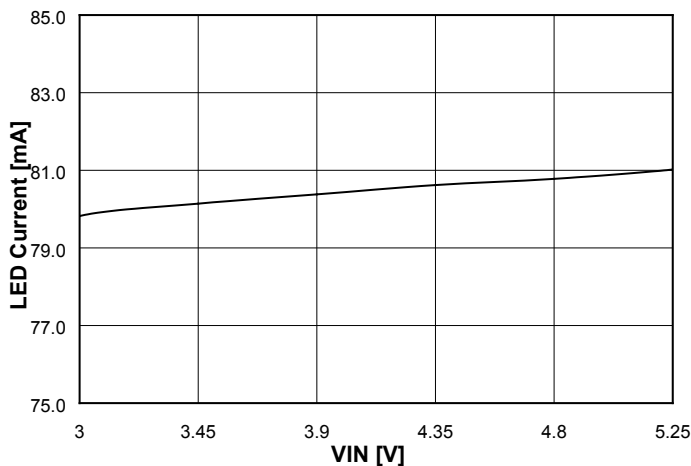

POWER MANAGEMENT

Typical Characteristics (Cont.)

Flash Mode Ripple, R_{ISET} = 1.25Ω

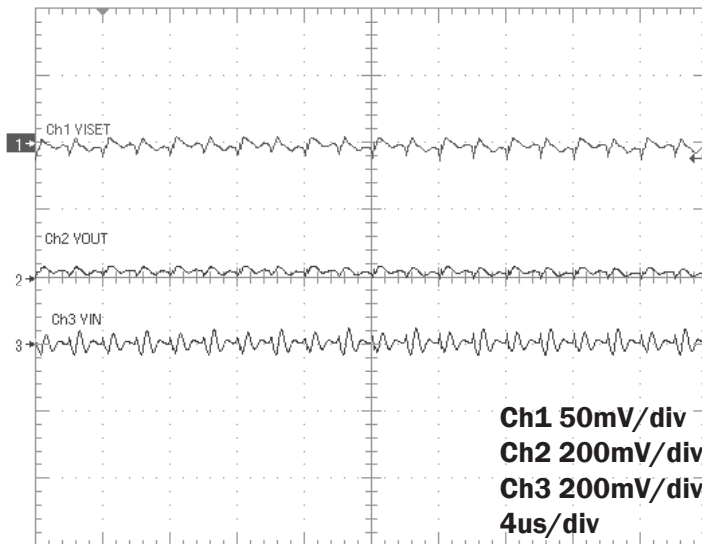

Spotlight Mode Ripple, R_{ISET} = 1.25Ω

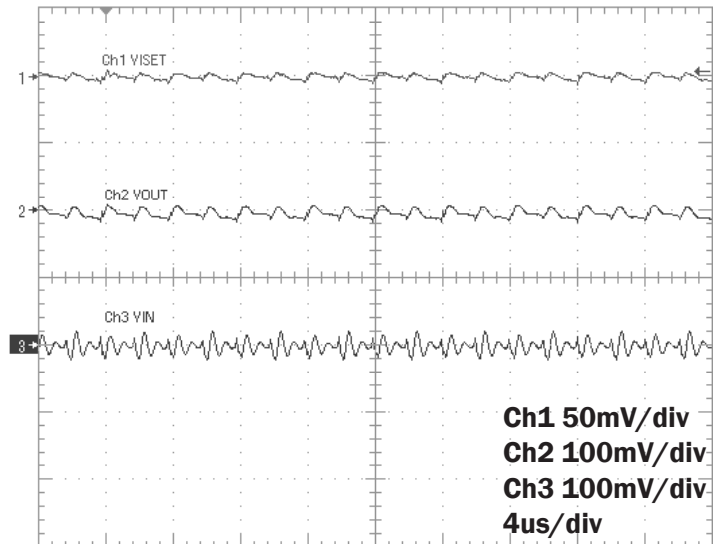

Startup Flash Mode 200mA

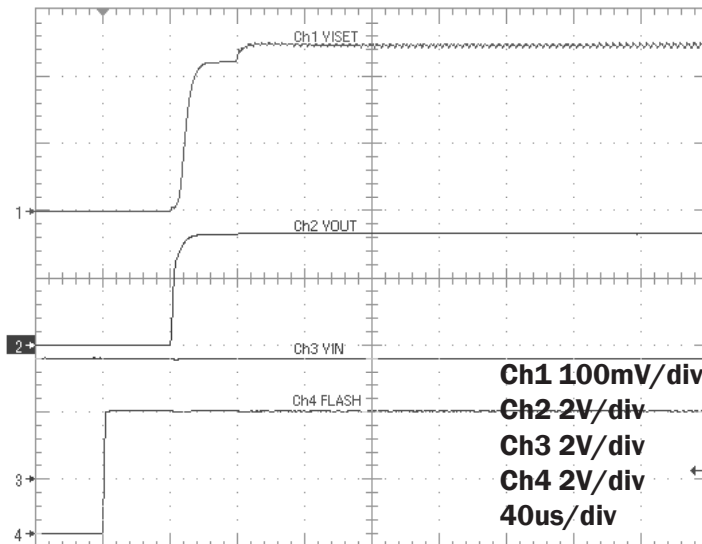

POWER MANAGEMENT

Suggested Layout

Layout Guidelines

The following layout is suggested for a two-layer design. The capacitors C1 and C2 are the bucket capacitors and each conducts the full load current of up to 200mA pulsed for one half clock cycle. C3 is the output decoupling capacitor placed near the SC635 VOUT pin. C4 is the input decoupling capacitor placed near the SC635 VIN pin. Multiple vias should be used whenever it is necessary to change layers on nets connecting to pins VIN, VOUT, GND, C1-, C1+, C2- and C2+. Resistor R1 is routed with a very low resistance connection between R1 and GND pin 3.

The sense trace between Pin 6 and R1 is routed around the ground via, allowing the shortest ground return path possible. The sense trace is connected to R1 at the positive terminal pad for the most accurate output possible. The bottom copper layer is mostly a ground plane with no obstructions between the ground vias. The smaller rectangle to the left connects the input power to VIN pin 1 and input capacitor C4. The two traces at the lower left are for logic inputs FLASH and CTRL. The trace to the right is the ISET pin "sense" trace. The sense trace is routed out of the path of the returning ground current.

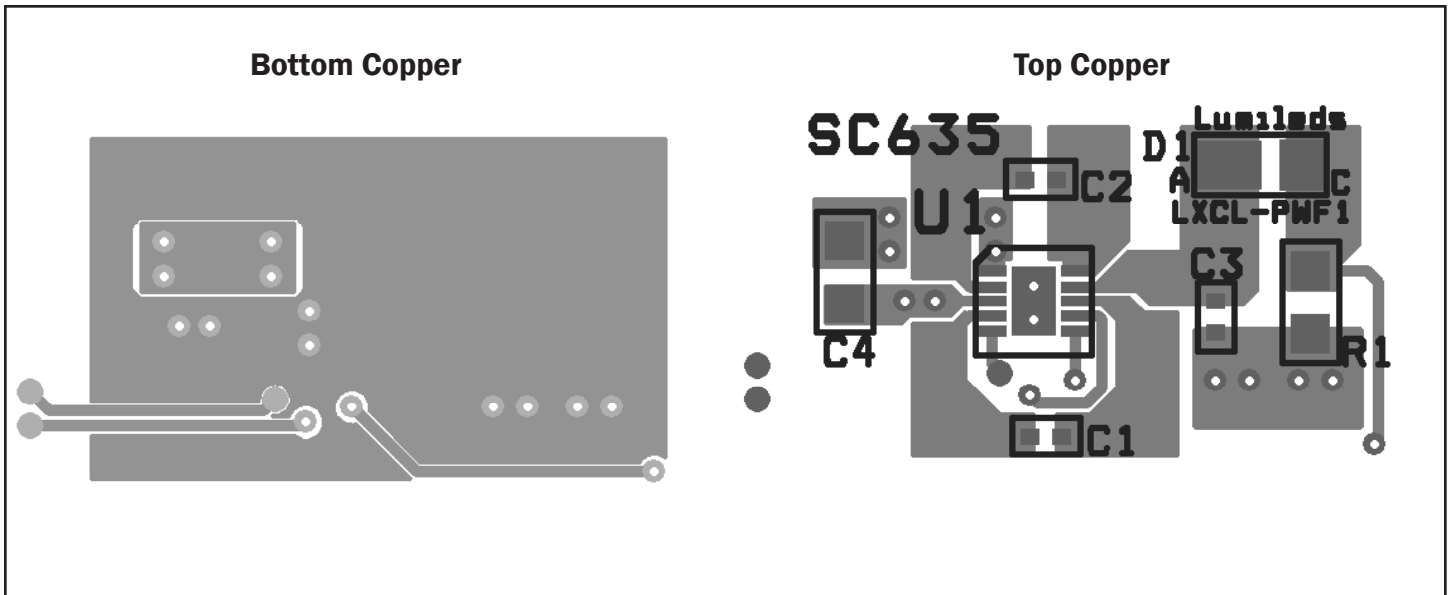

POWER MANAGEMENT

Block Diagram

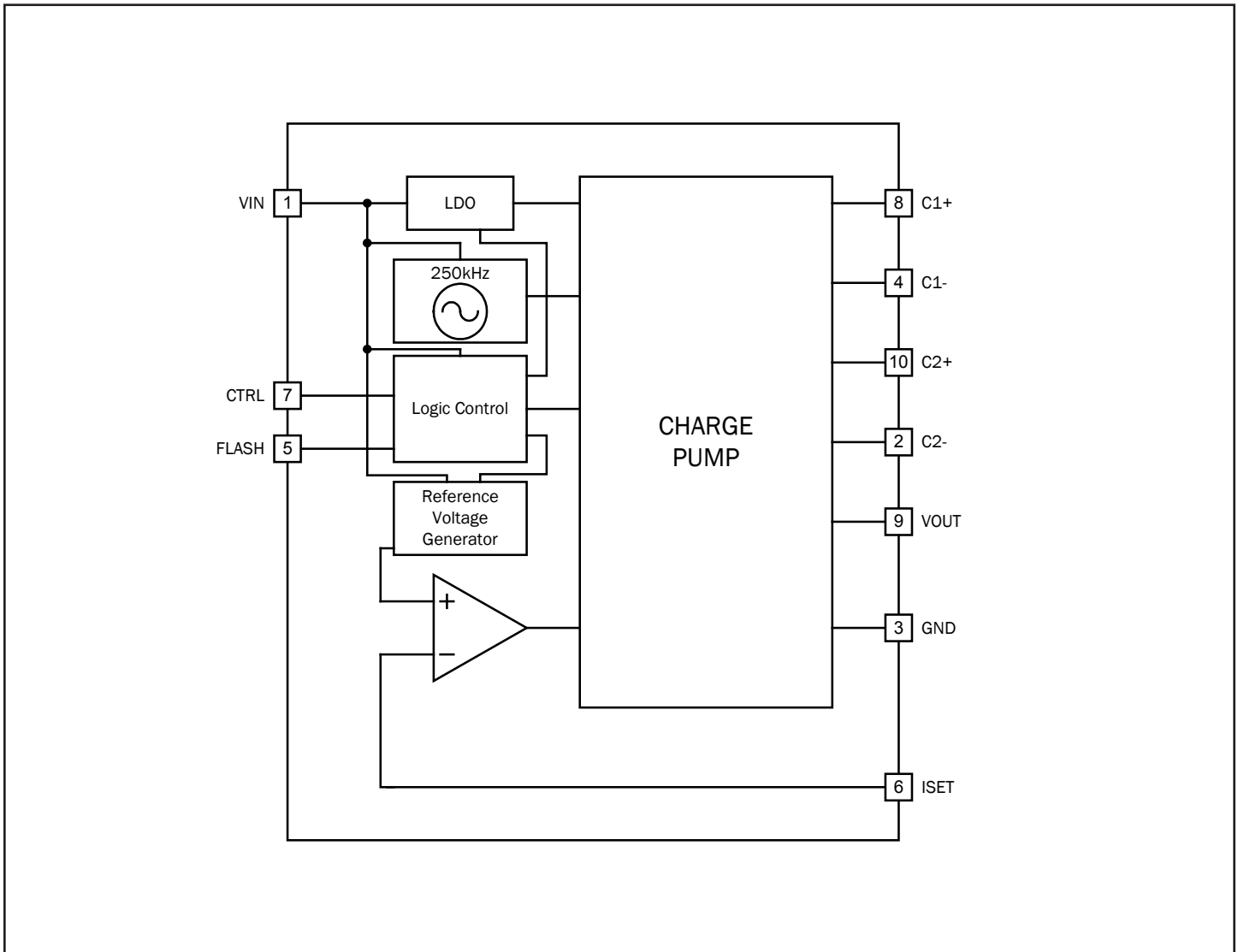

POWER MANAGEMENT

Outline Drawing - MLPD-10

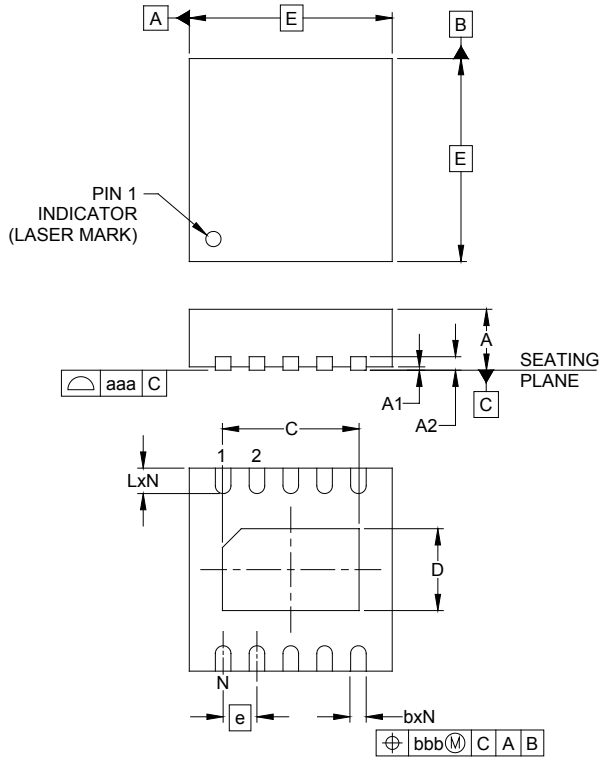

DIM	INCHES			MILLIMETERS		
	MIN	NOM	MAX	MIN	NOM	MAX
A	.031	-	.039	0.80	-	1.00
A1	.000	-	.002	0.00	-	0.05
A2	-	(.008)	-	-	(0.20)	-
b	.007	.009	.011	0.18	0.23	0.30
C	.074	.079	.083	1.87	2.02	2.12
D	.042	.048	.052	1.06	1.21	1.31
E	.114	.118	.122	2.90	3.00	3.10
e	.020 BSC			0.50 BSC		
L	.012	.016	.020	0.30	0.40	0.50
N	10			10		
aaa	.003			0.08		
bbb	.004			0.10		

- NOTES:
1. CONTROLLING DIMENSIONS ARE IN MILLIMETERS (ANGLES IN DEGREES).
 2. COPLANARITY APPLIES TO THE EXPOSED PAD AS WELL AS TERMINALS.

Marking Information

Top Mark



yyww = Datecode (Example = 0552)

xxxx = Semtech Lot Number

POWER MANAGEMENT

Land Pattern - MLPD-10

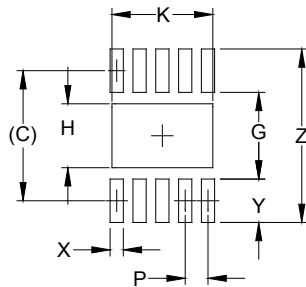

DIMENSIONS		
DIM	INCHES	MILLIMETERS
C	(.112)	(2.85)
G	.075	1.90
H	.055	1.40
K	.087	2.20
P	.020	0.50
X	.012	0.30
Y	.037	0.95
Z	.150	3.80

NOTES:

1. THIS LAND PATTERN IS FOR REFERENCE PURPOSES ONLY. CONSULT YOUR MANUFACTURING GROUP TO ENSURE YOUR COMPANY'S MANUFACTURING GUIDELINES ARE MET.

Contact Information

Taiwan Branch
Tel: 886-2-2748-3380
Fax: 886-2-2748-3390

Semtech Switzerland GmbH
Japan Branch
Tel: 81-3-6408-0950
Fax: 81-3-6408-0951

Korea Branch
Tel: 82-2-527-4377
Fax: 82-2-527-4376

Semtech Limited (U.K.)
Tel: 44-1794-527-600
Fax: 44-1794-527-601

Shanghai Office
Tel: 86-21-6391-0830
Fax: 86-21-6391-0831

Semtech France SARL
Tel: 33-(0)169-28-22-00
Fax: 33-(0)169-28-12-98

Semtech International AG is a wholly-owned subsidiary of Semtech Corporation, which has its headquarters in the U.S.A.

Semtech Germany GmbH
Tel: 49-(0)8161-140-123
Fax: 49-(0)8161-140-124