

# General purpose (dual digital transistors)

## EMD2 / UMD2N / IMD2A

### ●Features

- 1) Both the DTA124E chip and DTC124E chip in a EMT or UMT or SMT package.
- 2) Mounting possible with EMT6 or UMT6 or SMT6 automatic mounting machines.
- 3) Transistor elements are independent, eliminating interference.
- 4) Mounting cost and area can be cut in half.

### ●Structure

Epitaxial planar type

NPN / PNP silicon transistor (Built-in resistor type)

The following characteristics apply to both the DTr1 and DTr2, however, the “-” sign on DTr2 values for the PNP type have been omitted.

### ●Equivalent circuit

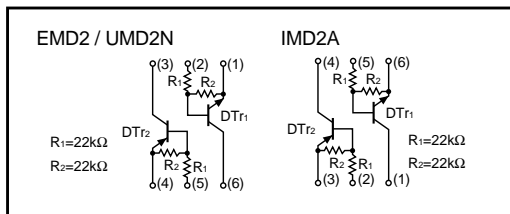

### ●Absolute maximum ratings (Ta = 25°C)

Parameter	Symbol	Limits	Unit
Supply voltage	V <sub>CC</sub>	50	V
Input voltage	V <sub>IN</sub>	40	V
		-10	
Output current	I <sub>O</sub>	30	mA
	I <sub>C (Max.)</sub>	100	
Power dissipation	P <sub>d</sub>	150 (TOTAL)	mW
		300 (TOTAL)	
Junction temperature	T <sub>j</sub>	150	°C
Storage temperature	T <sub>stg</sub>	-55 to +150	°C

\*1 120mW per element must not be exceeded.

\*2 200mW per element must not be exceeded.

### ●External dimensions (Unit : mm)

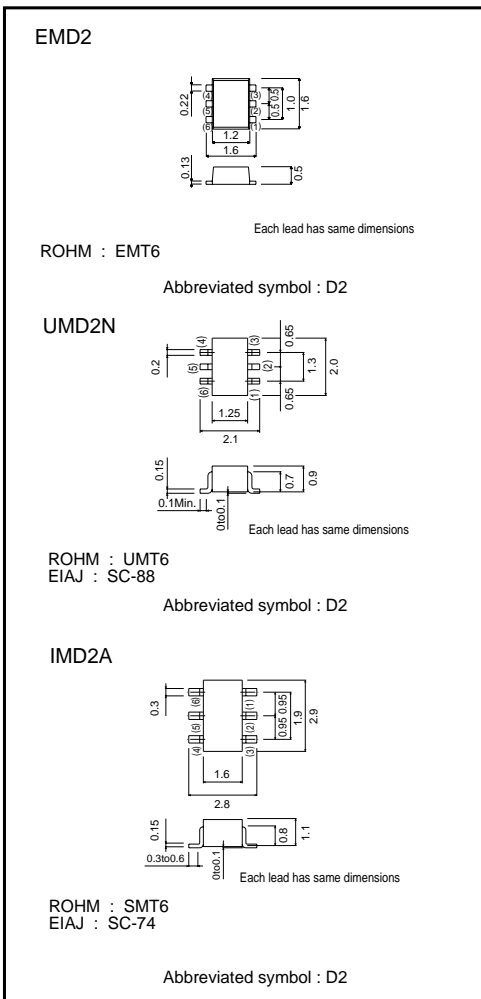

Transistors

●Electrical characteristics (Ta = 25°C)

Parameter	Symbol	Min.	Typ.	Max.	Unit	Conditions
Input voltage	$V_{I(off)}$	–	–	0.5	V	$V_{CC}=5V, I_o=100\mu A$
	$V_{I(on)}$	3	–	–		$V_o=0.2V, I_o=10mA$
Output voltage	$V_{O(on)}$	–	0.1	0.3	V	$I_o=10mA, I_i=0.5mA$
Input current	$I_i$	–	–	0.36	mA	$V_i=5V$
Output current	$I_{O(off)}$	–	–	0.5	$\mu A$	$V_{CC}=50V, V_i=0V$
DC current gain	$G_i$	56	–	–	–	$V_o=5V, I_o=5mA$
Transition frequency	$f_T$	–	250	–	MHz	$V_{CE}=10mA, I_E=-5mA, f=100MHz$ *
Input resistance	$R_i$	15.4	22	28.6	$k\Omega$	–
Resistance ratio	$R_2/R_1$	0.8	1	1.2	–	–

\* Transition frequency of the device

●Packaging specifications

Type	Package	Taping		
	Code	T2R	TR	T148
	Basic ordering unit (pieces)	8000	3000	3000
EMD2	○	—	—	—
UMD2N	—	○	—	—
IMD2A	—	—	—	○

●Electrical characteristic curves

DTr1 (NPN)

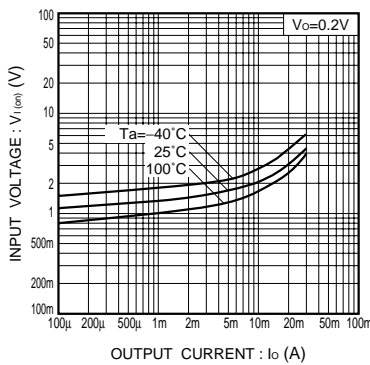

Fig.1 Input voltage vs. output current (ON characteristics)

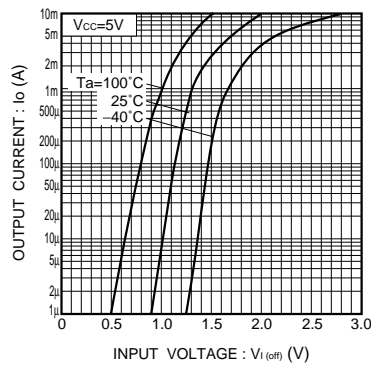

Fig.2 Output current vs. input voltage (OFF characteristics)

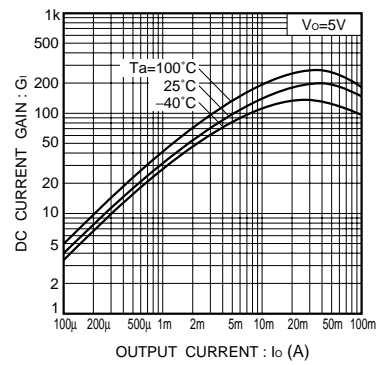

Fig.3 DC current gain vs. output current

Transistors

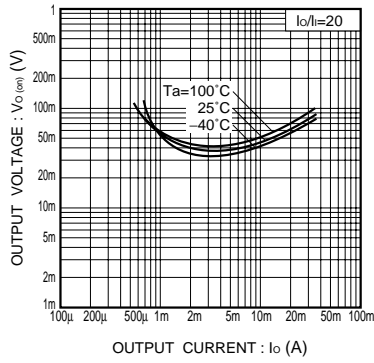

Fig.4 Output voltage vs. output current

DT<sub>r2</sub> (PNP)

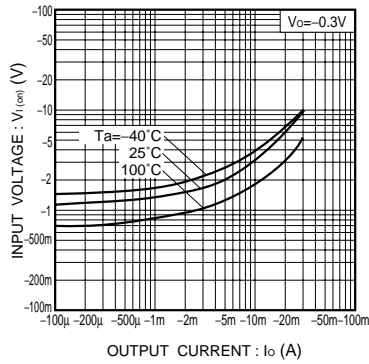

Fig.5 Input voltage vs. output current (ON characteristics)

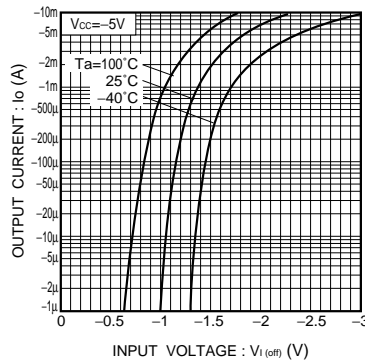

Fig.6 Output current vs. input voltage (OFF characteristics)

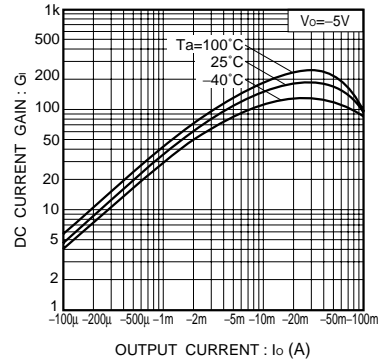

Fig.7 DC current gain vs. output current

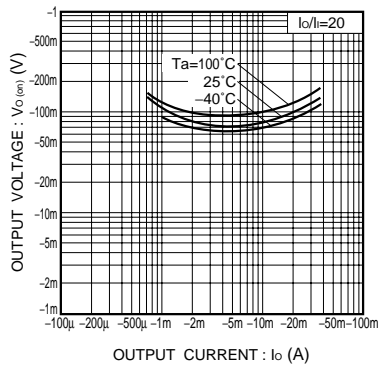

Fig.8 Output voltage vs. output current