

# BZT52-S-FL Series

## List

List..... 1

Package outline..... 2

Features..... 2

Mechanical data..... 2

Maximum ratings ..... 2

Electrical characteristics..... 3~4

Rating and characteristic curves..... 5~6

Pinning information..... 7

Suggested solder pad layout..... 7

Packing information..... 8

Reel packing..... 9

Suggested thermal profiles for soldering processes..... 9

High reliability test capabilities..... 10

# BZT52-S-FL Series

## 200mW Surface Mount Zener Diodes - 2.4V- 75V

### Features

- Wide Zener Voltage Range Selection, 2.4V to 75V
- 5% tolerance of Zener voltage for suffix "C" ex: BZT52C2V4S-FL
- 2% tolerance of Zener voltage for suffix "B" ex: BZT52B2V4S-FL
- Flat Lead SOD-323FL Plastic Package
- Surface Device Type Mounting
- RoHS Compliant
- Green EMC
- Matte Tin(Sn) Lead Finish
- Suffix "-H" indicates Halogen free parts, ex. BZT52C2V4S-FL-H.

### Mechanical data

- Epoxy:UL94-VO rated flame retardant
- Case : Molded plastic, SOD-323FL
- Terminals : Solder plated, solderable per MIL-STD-750, Method 2026
- Polarity : Indicated by cathode band
- Mounting Position : Any
- Weight : Approximated 0.004 gram

### Package outline

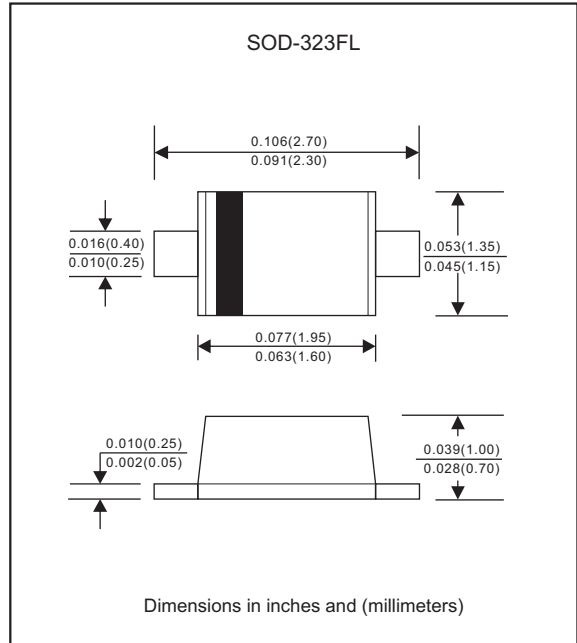

### Maximum ratings (at $T_A=25^\circ\text{C}$ unless otherwise noted)

PARAMETER	CONDITIONS	Symbol	MIN.	TYP.	MAX.	UNIT
Forward voltage	$I_F = 10 \text{ mA}$	$V_F$			1.0	V
Power dissipation	$T_A = 25^\circ\text{C}$	$P_D$			200	mW
Operating junction temperature range		$T_J$	-65		+150	$^\circ\text{C}$
Storage temperature range		$T_{STG}$	-65		+150	$^\circ\text{C}$

These ratings are limiting values above which the serviceability of the diode may be impaired.

# BZT52-S-FL Series

## Electrical characteristics (at $T_A=25^\circ\text{C}$ unless otherwise noted)

Part No.	Marking code	Zener voltage			Test current	Zener impedance			Leakage current	
		$V_Z @ I_{ZT}$				$I_{ZT}$	$Z_{ZT} @ I_{ZT}$	$Z_{ZK} @ I_{ZK}$	$I_{ZK}$	$I_R$
		Min.(V)	Nom.(V)	Max.(V)	mA	( $\Omega$ )Max	( $\Omega$ )Max	mA	( $\mu\text{A}$ )Max	Volts
BZT52C2V4S-FL	Z0	2.28	2.4	2.52	5	100	564	1.0	45	1.0
BZT52C2V7S-FL	Z1	2.57	2.7	2.84	5	100	564	1.0	18	1.0
BZT52C3V0S-FL	Z2	2.85	3.0	3.15	5	100	564	1.0	9	1.0
BZT52C3V3S-FL	Z3	3.14	3.3	3.47	5	95	564	1.0	4.5	1.0
BZT52C3V6S-FL	Z4	3.42	3.6	3.78	5	90	564	1.0	4.5	1.0
BZT52C3V9S-FL	Z5	3.71	3.9	4.10	5	90	564	1.0	2.7	1.0
BZT52C4V3S-FL	Z6	4.09	4.3	4.52	5	90	564	1.0	2.7	1.0
BZT52C4V7S-FL	Z7	4.47	4.7	4.94	5	80	470	1.0	2.7	2.0
BZT52C5V1S-FL	Z8	4.85	5.1	5.36	5	60	451	1.0	1.8	2.0
BZT52C5V6S-FL	Z9	5.32	5.6	5.88	5	40	376	1.0	0.9	2.0
BZT52C6V2S-FL	ZA	5.89	6.2	6.51	5	10	141	1.0	2.7	4.0
BZT52C6V8S-FL	ZB	6.46	6.8	7.14	5	15	75	1.0	1.8	4.0
BZT52C7V5S-FL	ZC	7.11	7.5	7.86	5	15	75	1.0	0.9	5.0
BZT52C8V2S-FL	ZD	7.79	8.2	8.61	5	15	75	1.0	0.63	5.0
BZT52C9V1S-FL	ZE	8.65	9.1	9.56	5	15	94	1.0	0.45	6.0
BZT52C10S-FL	ZF	9.50	10	10.50	5	20	141	1.0	0.18	7.0
BZT52C11S-FL	ZG	10.45	11	11.55	5	20	141	1.0	0.09	8.0
BZT52C12S-FL	ZH	11.40	12	12.60	5	25	141	1.0	0.09	8.0
BZT52C13S-FL	ZJ	12.35	13	13.65	5	30	160	1.0	0.09	8.0
BZT52C15S-FL	ZK	14.25	15	15.57	5	30	188	1.0	0.045	10.5
BZT52C16S-FL	ZL	15.20	16	16.80	5	40	188	1.0	0.045	11.2
BZT52C18S-FL	ZM	17.10	18	18.90	5	45	212	1.0	0.045	12.6
BZT52C20S-FL	ZN	19.00	20	21.00	5	55	212	1.0	0.045	14.0
BZT52C22S-FL	ZP	20.90	22	23.10	5	55	235	1.0	0.045	15.4
BZT52C24S-FL	ZR	22.80	24	25.20	5	70	235	1.0	0.045	16.8
BZT52C27S-FL	ZS	25.65	27	28.35	2	80	282	0.5	0.045	18.9
BZT52C30S-FL	ZT	28.50	30	31.50	2	80	282	0.5	0.045	21.0
BZT52C33S-FL	ZU	31.35	33	34.65	2	80	306	0.5	0.045	23.0
BZT52C36S-FL	ZV	34.20	36	37.80	2	90	329	0.5	0.045	25.2
BZT52C39S-FL	ZW	37.05	39	40.95	2	130	329	0.5	0.045	27.3
BZT52C43S-FL	ZX	40.85	43	45.15	2	150	353	0.5	0.045	30.1
BZT52C47S-FL	ZY	44.65	47	49.35	2	170	353	0.5	0.045	33.0
BZT52C51S-FL	Z-	48.45	51	53.55	2	180	376	0.5	0.045	35.7
BZT52C56S-FL	Z=	53.20	56	58.80	2	200	400	0.5	0.045	39.2
BZT52C62S-FL	Z≡	58.90	62	65.10	2	215	423	0.5	0.045	43.4
BZT52C68S-FL	Z>	64.60	68	71.40	2	240	447	0.5	0.045	47.6
BZT52C75S-FL	Z<	71.25	75	78.75	2	255	470	0.5	0.045	52.5

## Notes:

1. The Zener Voltage ( $V_Z$ ) is tested under pulse condition of 10ms.
2. The device numbers listed have a standard tolerance on the nominal zener voltage of  $\pm 5\%$ .
3. The zener impedance is derived from the 60-cycle ac voltage, which results when an ac current having an rms value equal to 10% of the dc zener current ( $I_{ZT}$  or  $I_{ZK}$ ) is superimposed to  $I_{ZT}$  or  $I_{ZK}$ .

# BZT52-S-FL Series

## Electrical characteristics (at $T_A=25^\circ\text{C}$ unless otherwise noted)

Part No.	Marking code	Zener voltage			Test current	Zener impedance			Leakage current	
		$V_Z @ I_{ZT}$				$I_{ZT}$	$Z_{ZT} @ I_{ZT}$	$Z_{ZK} @ I_{ZK}$	$I_{ZK}$	$I_R$
		Min.(V)	Nom.(V)	Max.(V)	mA	( $\Omega$ )Max	( $\Omega$ )Max	mA	( $\mu\text{A}$ )Max	Volts
BZT52B2V4S-FL	0Z	2.35	2.4	2.45	5	100	564	1.0	45	1.0
BZT52B2V7S-FL	1Z	2.65	2.7	2.75	5	100	564	1.0	18	1.0
BZT52B3V0S-FL	2Z	2.94	3.0	3.06	5	100	564	1.0	9	1.0
BZT52B3V3S-FL	3Z	3.23	3.3	3.37	5	95	564	1.0	4.5	1.0
BZT52B3V6S-FL	4Z	3.53	3.6	3.67	5	90	564	1.0	4.5	1.0
BZT52B3V9S-FL	5Z	3.82	3.9	3.98	5	90	564	1.0	2.7	1.0
BZT52B4V3S-FL	6Z	4.21	4.3	4.39	5	90	564	1.0	2.7	1.0
BZT52B4V7S-FL	7Z	4.61	4.7	4.79	5	80	470	1.0	2.7	2.0
BZT52B5V1S-FL	8Z	5.00	5.1	5.20	5	60	451	1.0	1.8	2.0
BZT52B5V6S-FL	9Z	5.49	5.6	5.71	5	40	376	1.0	0.9	2.0
BZT52B6V2S-FL	AZ	6.08	6.2	6.32	5	10	141	1.0	2.7	4.0
BZT52B6V8S-FL	BZ	6.66	6.8	6.94	5	15	75	1.0	1.8	4.0
BZT52B7V5S-FL	CZ	7.35	7.5	7.65	5	15	75	1.0	0.9	5.0
BZT52B8V2S-FL	DZ	8.04	8.2	8.36	5	15	75	1.0	0.63	5.0
BZT52B9V1S-FL	EZ	8.92	9.1	9.28	5	15	94	1.0	0.45	6.0
BZT52B10S-FL	FZ	9.80	10	10.20	5	20	141	1.0	0.18	7.0
BZT52B11S-FL	GZ	10.78	11	11.22	5	20	141	1.0	0.09	8.0
BZT52B12S-FL	HZ	11.76	12	12.24	5	25	141	1.0	0.09	8.0
BZT52B13S-FL	JZ	12.74	13	13.26	5	30	160	1.0	0.09	8.0
BZT52B15S-FL	KZ	14.70	15	15.30	5	30	188	1.0	0.045	10.5
BZT52B16S-FL	LZ	15.68	16	16.32	5	40	188	1.0	0.045	11.2
BZT52B18S-FL	MZ	17.64	18	18.36	5	45	212	1.0	0.045	12.6
BZT52B20S-FL	NZ	19.60	20	20.40	5	55	212	1.0	0.045	14.0
BZT52B22S-FL	PZ	21.56	22	22.44	5	55	235	1.0	0.045	15.4
BZT52B24S-FL	RZ	23.52	24	24.48	5	70	235	1.0	0.045	16.8
BZT52B27S-FL	SZ	26.46	27	27.54	2	80	282	0.5	0.045	18.9
BZT52B30S-FL	TZ	29.40	30	30.60	2	80	282	0.5	0.045	21.0
BZT52B33S-FL	UZ	32.34	33	33.66	2	80	306	0.5	0.045	23.0
BZT52B36S-FL	VZ	35.28	36	36.72	2	90	329	0.5	0.045	25.2
BZT52B39S-FL	WZ	38.22	39	39.78	2	130	329	0.5	0.045	27.3
BZT52B43S-FL	XZ	42.14	43	43.86	2	150	353	0.5	0.045	30.1
BZT52B47S-FL	YZ	46.06	47	47.94	2	170	353	0.5	0.045	33.0
BZT52B51S-FL	-Z	49.98	51	52.02	2	180	376	0.5	0.045	35.7
BZT52B56S-FL	=Z	54.88	56	57.12	2	200	400	0.5	0.045	39.2
BZT52B62S-FL	≡Z	60.76	62	63.24	2	215	423	0.5	0.045	43.4
BZT52B68S-FL	>Z	66.64	68	69.36	2	240	447	0.5	0.045	47.6
BZT52B75S-FL	<Z	73.50	75	76.50	2	255	470	0.5	0.045	52.5

## Notes:

1. The Zener Voltage ( $V_Z$ ) is tested under pulse condition of 10ms.
2. The device numbers listed have a standard tolerance on the nominal zener voltage of  $\pm 2\%$ .
3. The zener impedance is derived from the 60-cycle ac voltage, which results when an ac current having an rms value equal to 10% of the dc zener current ( $I_{ZT}$  or  $I_{ZK}$ ) is superimposed to  $I_{ZT}$  or  $I_{ZK}$ .

## Rating and characteristic curves (BZT52-S-FL Series )

FIG. 1-POWER DISSIPATION VS. AMBIENT TEMP.

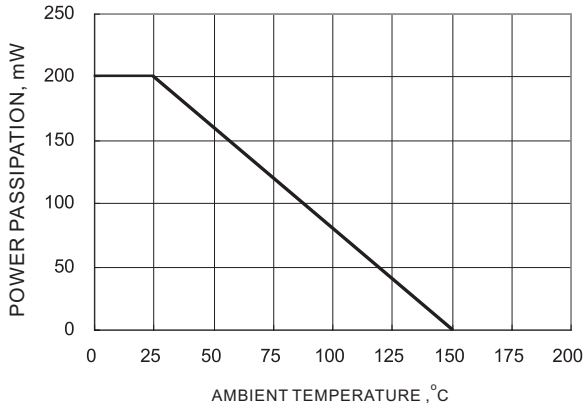

FIG. 2-EFFECT OF ZENER VOLTAGE ON ZENER IMPEDANCE

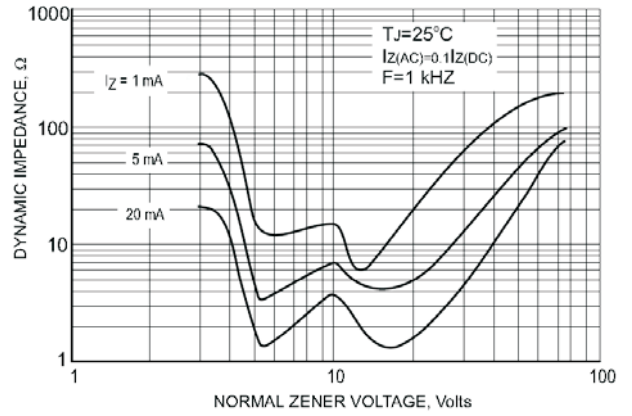

FIG. 3-TYPICAL FORWARD VOLTAGE

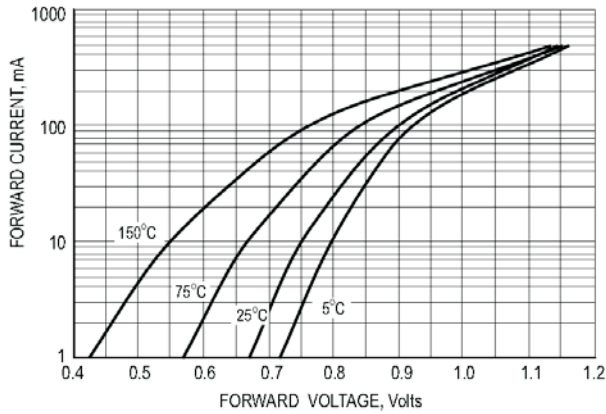

FIG. 4-TYPICAL CAPACITANCE

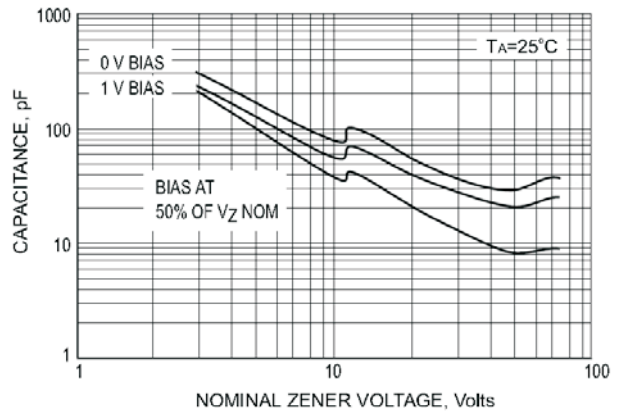

FIG. 5-ZENER BREAKDOWN CHARACTERISTICS

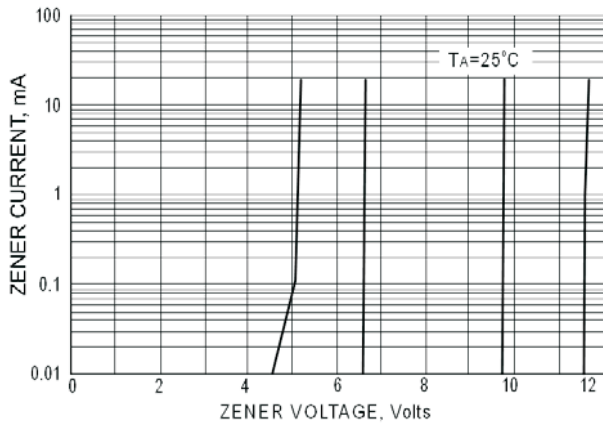
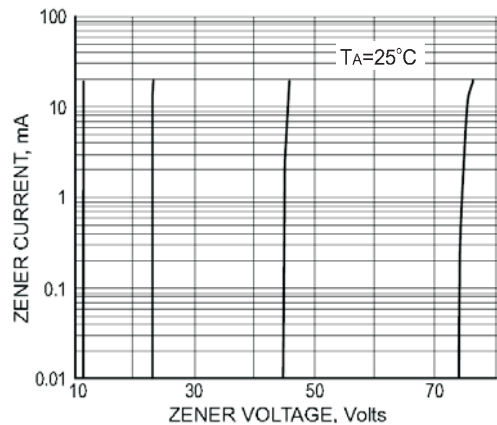
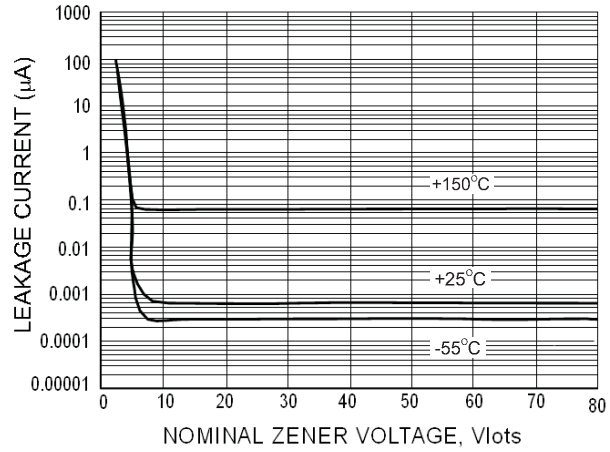

FIG. 6-ZENER BREAKDOWN CHARACTERISTICS





## Rating and characteristic curves (BZT52-S-FL Series )

FIG. 7-TYPICAL LEAKGE CURRENT



# BZT52-S-FL Series

## Pinning information

Pin	Simplified outline	Symbol
Pin1 cathode Pin2 anode		

## Suggested solder pad layout

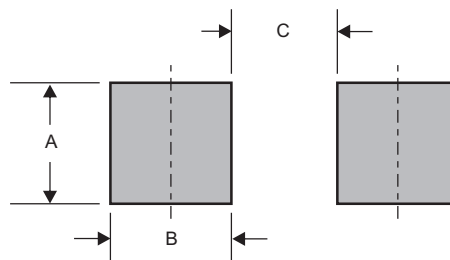

Dimensions in inches and (millimeters)

PACKAGE	A	B	C
SOD-323FL	0.032 (0.82)	0.022 (0.56)	0.069 (1.75)

# BZT52-S-FL Series

## Packing information

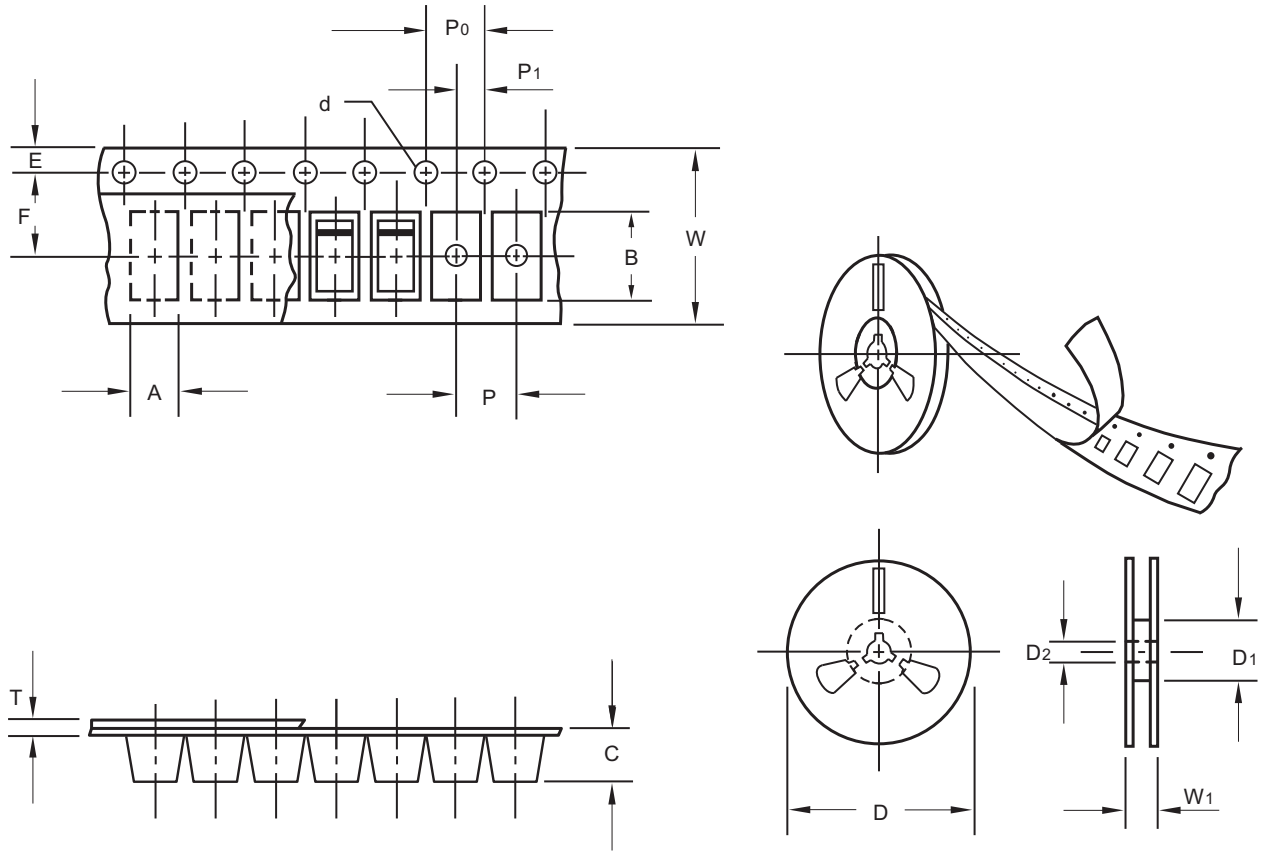

unit:mm

Item	Symbol	Tolerance	SOD-323FL
Carrier width	A	0.1	1.46
Carrier length	B	0.1	2.95
Carrier depth	C	0.1	1.25
Sprocket hole	d	0.1	1.50
13" Reel outside diameter	D	2.0	-
13" Reel inner diameter	D1	min	-
7" Reel outside diameter	D	2.0	178.00
7" Reel inner diameter	D1	min	62.00
Feed hole diameter	D2	0.5	13.00
Sprocket hole position	E	0.1	1.75
Punch hole position	F	0.1	3.50
Punch hole pitch	P	0.1	4.00
Sprocket hole pitch	P0	0.1	4.00
Embossment center	P1	0.1	2.00
Overall tape thickness	T	0.1	0.23
Tape width	W	0.3	8.00
Reel width	W1	1.0	11.40

Note: Devices are packed in accordance with EIA standard RS-481-A and specifications listed above.



# BZT52-S-FL Series

## Reel packing

PACKAGE	REEL SIZE	REEL (pcs)	COMPONENT SPACING (m/m)	BOX (pcs)	INNER BOX (m/m)	REEL DIA, (m/m)	CARTON SIZE (m/m)	CARTON (pcs)	APPROX. GROSS WEIGHT (kg)
SOD-323FL	7"	3,000	4.0	30,000	183*183*123	178	382*262*387	240,000	9.5

## Suggested thermal profiles for soldering processes

- 1.Storage environment: Temperature=5°C~40°C Humidity=55%±25%
- 2.Reflow soldering of surface-mount devices

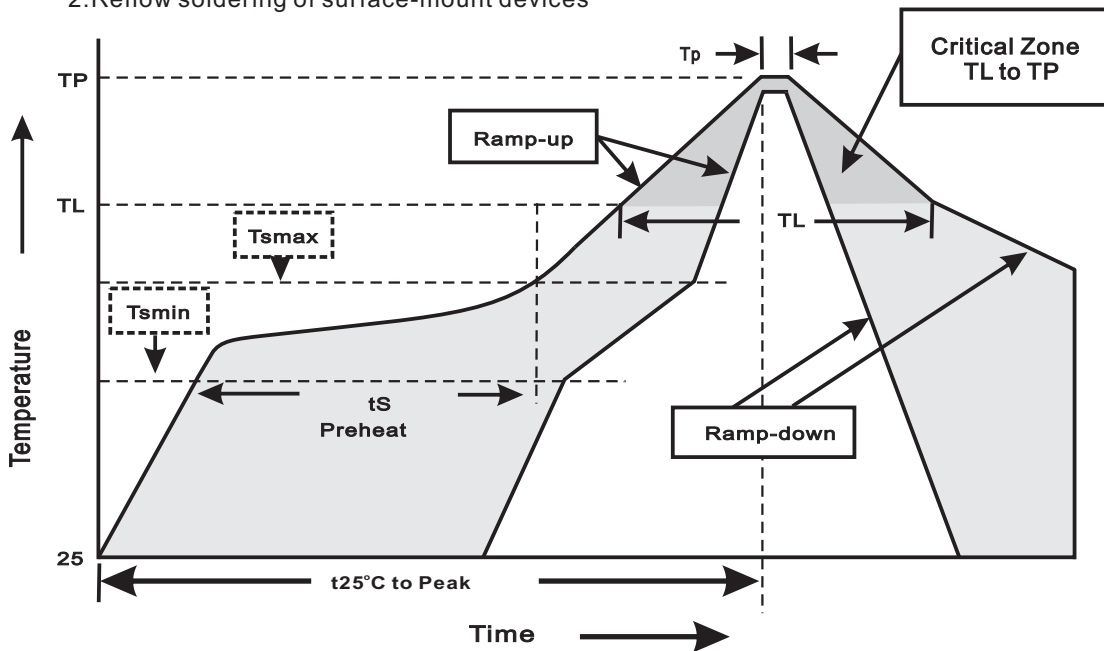

### 3.Reflow soldering

Profile Feature	Soldering Condition
Average ramp-up rate(TL to TP)	<3°C/sec
Preheat -Temperature Min(Tsmin) -Temperature Max(Tsmax) -Time(min to max)(ts)	150°C 200°C 60~120sec
Tsmax to TL -Ramp-upRate	<3°C/sec
Time maintained above: -Temperature(TL) -Time(tL)	217°C 60~260sec
Peak Temperature(TP)	255°C-0/+5°C
Time within 5°C of actual Peak Temperature(tp)	10~30sec
Ramp-down Rate	<6°C/sec
Time 25°C to Peak Temperature	<6minutes

# BZT52-S-FL Series

## High reliability test capabilities

Item Test	Conditions	Reference
1. Solder Resistance	at $260\pm 5^{\circ}\text{C}$ for $10\pm 2\text{sec.}$ immerse body into solder $1/16''\pm 1/32''$	MIL-STD-750D METHOD-2031
2. Solderability	at $245\pm 5^{\circ}\text{C}$ for 5 sec.	MIL-STD-202F METHOD-208
3. High Temperature Reverse Bias	$V_R=80\%$ rate at $T_J=150^{\circ}\text{C}$ for 168 hrs.	MIL-STD-750D METHOD-1038
4. Pressure Cooker	$15P_{SIE}$ at $T_A=121^{\circ}\text{C}$ for 4 hrs.	JESD22-A102
5. Temperature Cycling	$-55^{\circ}\text{C}$ to $+125^{\circ}\text{C}$ dwelled for 30 min. and transferred for 5min. total 10 cycles.	MIL-STD-750D METHOD-1051
6. Humidity	at $T_A=85^{\circ}\text{C}$ , RH=85% for 1000hrs.	MIL-STD-750D METHOD-1021
7. High Temperature Storage Life	at $175^{\circ}\text{C}$ for 1000 hrs.	MIL-STD-750D METHOD-1031