



DATA SHEET

GBPC12005~GBPC1208

HIGH CURRENT SILICON BRIDGE RECTIFIER

VOLTAGE - 50 to 800 Volts CURRENT - 12 Amperes

FEATURES

- Plastic material has Underwriters Laboratory Flammability Classification 94V-O
- The plastic package has Underwriters Laboratory Flammability Classification 94V-O.
- Surge overload ratings to 200 Amperes .

MECHANICAL DATA

Case: Molded plastic with heatsink integrally mounded in the bridge encapsulation.

Mounting position: Any

Weight: 1 ounce, 30 grams

Terminals: Plated .25" FASTON

All Models are Available on B(Height)=7.62mm Max. Epoxy Case

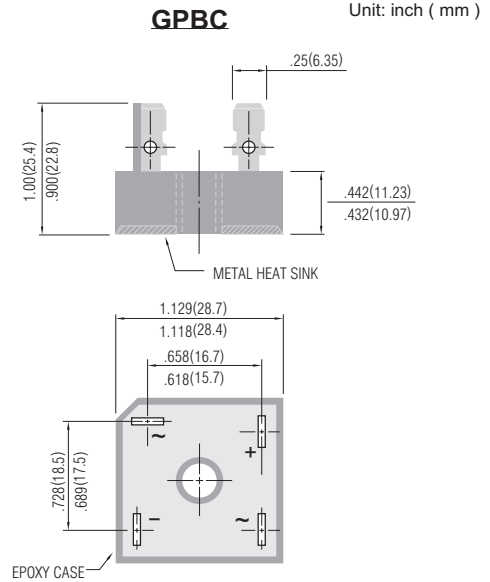

MAXIMUM RATINGS AND ELECTRICAL CHARACTERISTICS

Rating at 25°C ambient temperature unless otherwise specified. Resistive or inductive load, 60Hz.
For Capacitive load derate current by 20%.

	GBPC 12005	GBPC 1201	GBPC 1202	GBPC 1204	GBPC 1206	GBPC 1208	UNIT
Maximum Recurrent Peak Reverse Voltage	50	100	200	400	600	800	V
Maximum RMS Input Voltage	35	70	140	280	420	560	V
Maximum DC Blocking Voltage	50	100	200	400	600	800	V
DC Output Voltage, Resistive load	30	62	124	250	380	505	V
DC Output Voltage, Capacitive load	50	100	200	400	600	800	V
Maximum Average Forward Current For Resistive Load at TC=55°C	12						A
Non-repetitive Peak Forward Surge Current at Rated Load	200						A
Maximum Forward Voltage per Bridge Element at 6.0A Specified Current	1.2						V
Maximum Reverse Leakage Current at Rated @ T _A =25°C	10.0						µA
Dc Blocking Voltage @ T _A =100°C	1000						
I ² t Rating for fusing (t<8.35ms)	374 / 664						A ² S
Typical Thermal Resistance per leg (Fig 3) RθJC	2.0						°C / W
Operating Temperature Range, T _J	-55 to +150						°C
Storage Temperature Range, T _A	-55 to +150						°C



RATING AND CHARACTERISTIC CURVES

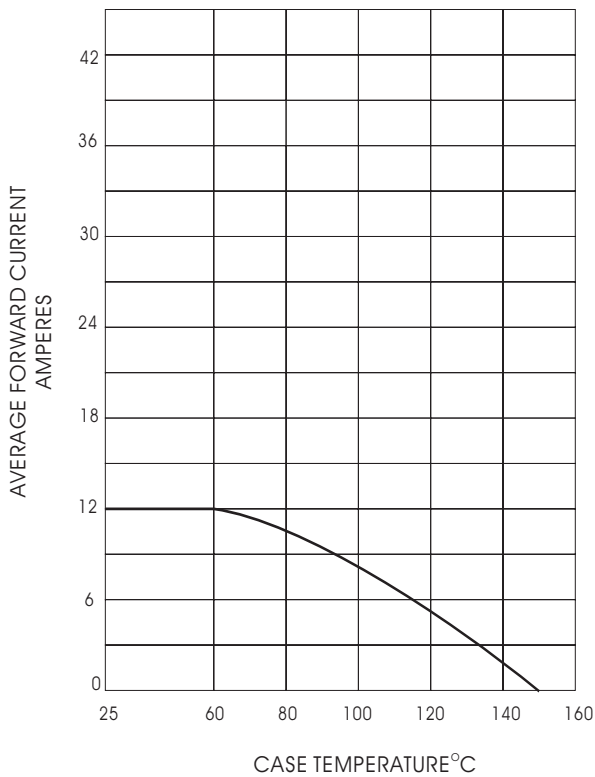

Fig. 1- OUTPUT CURRENT VS. CASE TEMPERATURE
RESISTIVE OR INDUCTIVE LOAD $T_J = 150^\circ\text{C}$

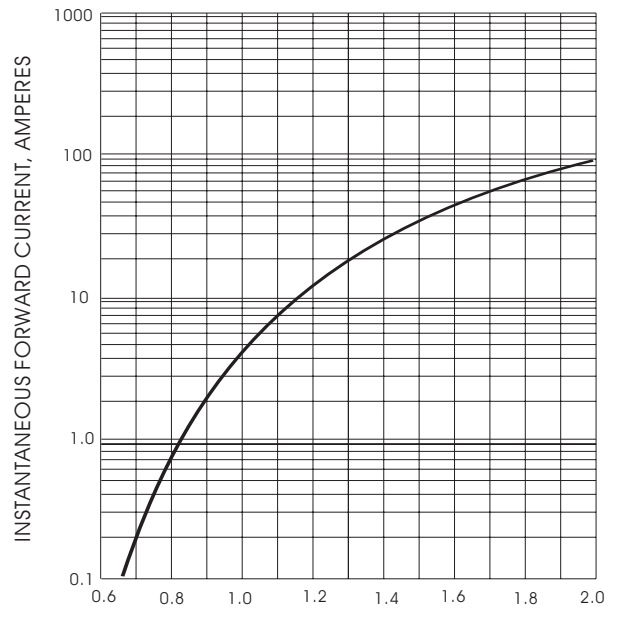

Fig. 2- TYPICAL INSTANTANEOUS
FORWARD CHARACTERISTICS
AT $T_J = 25^\circ\text{C}$

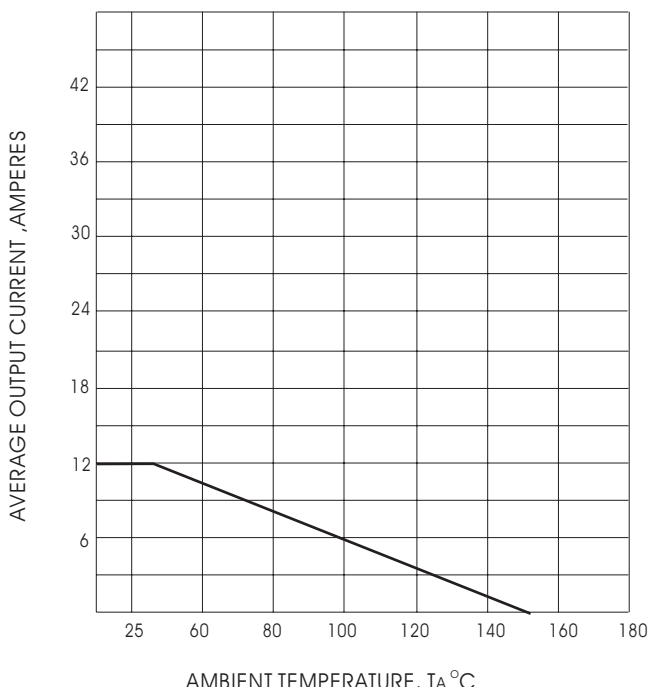

Fig. 3- OUTPUT CURRENT VS. AMBIENT TEMPERATURE
RESISTIVE OR INDUCTIVE LOAD
BRIDGE MOUNTED ON A 8" x 8" ALUMINUM PLATE 25" THICK

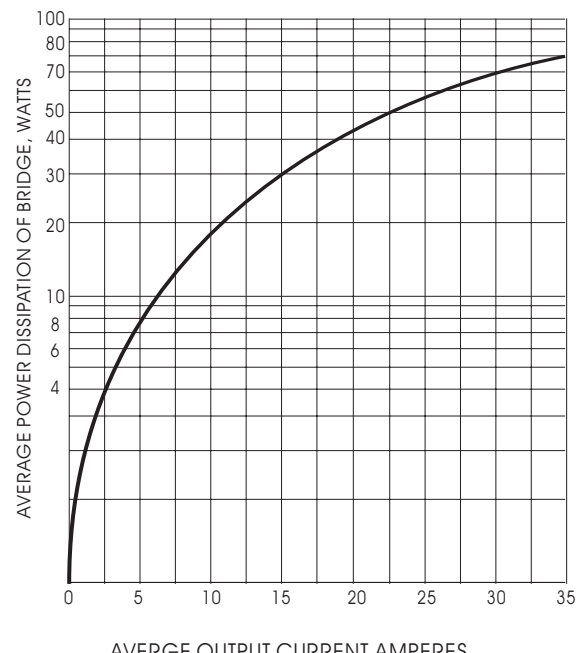

Fig. 4- POWER DISSIPATION VS. AVERAGE OUTPUT
CURRENT RESISTIVE OR INDUCTIVE LOAD
 $T_J = 150^\circ\text{C}$