



T-46-13-27

NMC93CS56/CS66 2048-Bit/4096-Bit Serial Electrically Erasable Programmable Memories

General Description

The NMC93CS56/NMC93CS66 are 2048/4096 bits of read/write memory divided into 128/256 registers of 16 bits each. N registers ($N \leq 128$ or $N \leq 256$) can be protected against data modification by programming into a special on-chip register, called the memory "protect register", the address of the first register to be protected. This address can be "locked" into the device, so that these registers can be permanently protected. Thereafter, all attempts to alter data in a register whose address is equal to or greater than the address stored in the "protect register" will be aborted.

The "read" instruction loads the address of the first register to be read into an 8-bit address pointer. Then the data is clocked out serially on the "DO" pin and automatically cycles to the next register to produce a serial data stream. In this way the entire memory can be read in one continuous data stream or as registers of varying length from 16 to 2048/4096 bits. Thus, the NMC93CS56/NMC93CS66 can be viewed as a non-volatile shift register.

The "write" cycle is completely self-timed. No separate erase cycle is required before write. The "write" cycle is only enabled when pin 6 (program enable) is held "high". If the address of the register to be written is less than the ad-

dress in the "protect register" then the data is written 16 bits at a time into one of the 128/256 data registers. If "CS" is brought "high" following the initiation of a "write" cycle, the "DO" pin indicates the ready/busy status of the chip.

National Semiconductor's EEPROMs are designed and tested for applications requiring extended endurance. Refer to device operation for further endurance information. Data retention is specified to be greater than 40 years.

Features

- Write protection in user defined section of memory
- Typical active current 400 μ A; Typical standby current 25 μ A
- Reliable CMOS floating gate technology
- 5 volt only operation in all modes
- MICROWIRE compatible serial I/O
- Self-timed programming cycle
- Device status signal during programming mode
- Sequential register read
- Over 40 years data retention
- Designed for 100,000 write cycles

Block Diagram

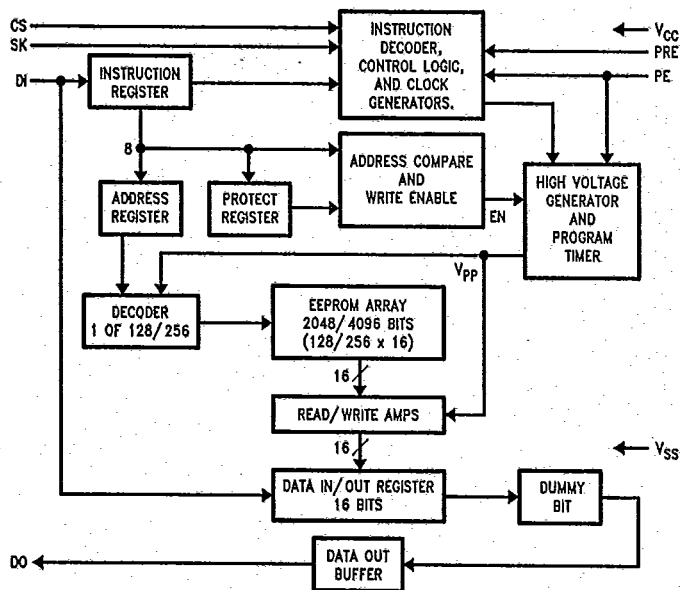

TL/D/9209-3

NMC93CS56/NMC93CS66

T-46-13-27

Connection Diagrams

PIN OUT:

Dual-In-Line Package (N)

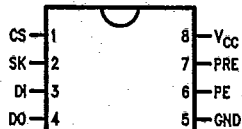

TL/D/9209-1

Top View

See NS Package Number N08E

Pin Names	
CS	Chip Select
SK	Serial Data Clock
DI	Serial Data Input
DO	Serial Data Output
GND	Ground
PE	Program Enable
PRE	Protect Register Enable
VCC	Power Supply

PIN OUT:

SO Package (M)

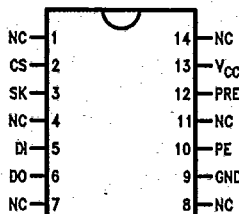

TL/D/9209-2

Top View

See NS Package Number M14A

Ordering Information

Commercial Temp. Range (0°C to +70°C)

Order Number
NMC93CS56N/NMC93CS66N
NMC93CS56M/NMC93CS66M

Extended Temp. Range (-40°C to +85°C)

Order Number
NMC93CS56EN/NMC93CS66EN
NMC93CS56EM/NMC93CS66EM

Military Temp. Range (-55°C to +125°C)

Order Number
NMC93CS56MN/NMC93CS66MN
NMC93CS56MM/NMC93CS66MM

Absolute Maximum Ratings (Note 1)

If Military/Aerospace specified devices are required, please contact the National Semiconductor Sales Office/Distributors for availability and specifications.

Ambient Storage Temperature	-65°C to +150°C
All Input or Output Voltages with Respect to Ground	+6.5V to -0.3V
Lead Temp. (Soldering, 10 sec.)	+300°C
ESD rating	2000V

Operating Conditions

Ambient Storage Temperature	0°C to +70°C
NMC93CS56/MNC93CS66	-40°C to +85°C
NMC93CS56E/NMC93CS66E	-55°C to +125°C
NMC93CS56M/NMC93CS66M (Mil. Temp.)	4.5V to 5.5V
Positive Power Supply	

T-46-13-27

DC and AC Electrical Characteristics $V_{CC} = 5V \pm 10\%$ (unless otherwise specified)

Symbol	Parameter	Part Number	Conditions	Min	Max	Units
I _{CC1}	Operating Current CMOS Input Levels	NMC93CS56/NMC93CS66	CS = V _{IH} , SK = 1 MHz		2	mA
		NMC93CS56E/NMC93CS66E	SK = 0.5 MHz		2	
		NMC93CS56M/NMC93CS66M*	SK = 0.5 MHz		2	
I _{CC2}	Operating Current TTL Input Levels	NMC93CS56/NMC93CS66	CS = V _{IH} , SK = 1 MHz		3	mA
		NMC93CS56E/NMC93CS66E	SK = 0.5 MHz		3	
		NMC93CS56M/NMC93CS66M	SK = 0.5 MHz		4	
I _{CC3}	Standby Current	NMC93CS56/NMC93CS66	CS = 0V		50	μA
		NMC93CS56E/NMC93CS66E			100	
		NMC93CS56M/NMC93CS66M			100	
I _{IL}	Input Leakage	NMC93CS56/NMC93CS66	V _{IN} = 0V to V _{CC}	-2.5	2.5	μA
		NMC93CS56E/NMC93CS66E		-10	10	
		NMC93CS56M/NMC93CS66M		-10	10	
I _{OL}	Output Leakage	NMC93CS56/NMC93CS66	V _{OUT} = 0V to V _{CC}	-2.5	2.5	μA
		NMC93CS56E/NMC93CS66E		-10	10	
		NMC93CS56M/NMC93CS66M		-10	10	
V _{IL} V _{IH}	Input Low Voltage Input High Voltage			-0.1	0.8	V
				2	V _{CC} + 1	
V _{OL1}	Output Low Voltage	NMC93CS56/NMC93CS66	I _{OL} = 2.1 mA		0.4	V
		NMC93CS56E/NMC93CS66E	I _{OL} = 2.1 mA		0.4	
		NMC93CS56M/NMC93CS66M	I _{OL} = 1.8 mA		0.4	
V _{OH1}	Output High Voltage		I _{OH} = -400 μA	2.4		V
V _{OL2} V _{OH2}	Output Low Voltage Output High Voltage		I _{OL} = 10 μA		0.2	V
			I _{OH} = -10 μA	V _{CC} - 0.2		
f _{SK}	SK Clock Frequency	NMC93CS56/NMC93CS66		0	1	MHz
		NMC93CS56E/NMC93CS66E		0	0.5	
		NMC93CS56M/NMC93CS66M		0	0.5	
t _{SKH}	SK High Time	NMC93CS56/NMC93CS66	(Note 2)	250		ns
		NMC93CS56E/NMC93CS66E	(Note 3)	500		
		NMC93CS56M/NMC93CS66M	(Note 3)	500		
t _{SKL}	SK Low Time	NMC93CS56/NMC93CS66	(Note 2)	250		ns
		NMC93CS56E/NMC93CS66E	(Note 3)	500		
		NMC93CS56M/NMC93CS66M	(Note 3)	500		
t _{CS}	Minimum CS Low Time	NMC93CS56/NMC93CS66	(Note 4)	250		ns
		NMC93CS56E/NMC93CS66E	(Note 5)	500		
		NMC93CS56M/NMC93CS66M	(Note 5)	500		
t _{CSS}	CS Setup Time	NMC93CS56/NMC93CS66	Relative to SK	50		ns
		NMC93CS56E/NMC93CS66E		100		
		NMC93CS56M/NMC93CS66M		100		
t _{PRES}	PRE Setup Time	NMC93CS56/NMC93CS66	Relative to SK	50		ns
		NMC93CS56E/NMC93CS66E		100		
		NMC93CS56M/NMC93CS66M		100		

*Through this table "M" refers to temperature range (-55°C to +125°C) not package.



NMC93CS56/NMC93CS66

DC and AC Electrical Characteristics

T-46-13-27

V_{CC} = 5V ±10% (unless otherwise specified) (Continued)

Symbol	Parameter	Part Number	Conditions	Min	Max	Units
t _{PES}	PE Setup Time	NMC93CS56/NMC93CS66 NMC93CS56E/NMC93CS66E NMC93CS56M/NMC93CS66M	Relative to SK	50 100 100		ns
t _{DIS}	DI Setup Time	NMC93CS56/NMC93CS66 NMC93CS56E/NMC93CS66E NMC93CS56M/NMC93CS66M	Relative to SK	100 200 200		ns
t _{CSH}	CS Hold Time		Relative to SK	0		ns
t _{PEH}	PE Hold Time	NMC93CS56/NMC93CS66 NMC93CS56E/NMC93CS66E NMC93CS56M/NMC93CS66M	Relative to CS Relative to CS Relative to CS	250 500 500		ns
t _{PREH}	PRE Hold Time		Relative to SK	0		ns
t _{DIH}	DI Hold Time	NMC93CS56/NMC93CS66 NMC93CS56E/NMC93CS66E NMC93CS56M/NMC93CS66M	Relative to SK	100 200 200		ns
t _{PD1}	Output Delay to "1"	NMC93CS56/NMC93CS66 NMC93CS56E/NMC93CS66E NMC93CS56M/NMC93CS66M	AC Test		500 1000 1000	ns
t _{PD0}	Output Delay to "0"	NMC93CS56/NMC93CS66 NMC93CS56E/NMC93CS66E NMC93CS56M/NMC93CS66M	AC Test		500 1000 1000	ns
t _{SV}	CS to Status Valid	NMC93CS56/NMC93CS66 NMC93CS56E/NMC93CS66E NMC93CS56M/NMC93CS66M	AC Test		500 1000 1000	ns
t _{DF}	CS to DO In TRI-STATE [®]	NMC93CS56/NMC93CS66 NMC93CS56E/NMC93CS66E NMC93CS56M/NMC93CS66M	AC Test CS = V _{IL}		100 200 200	ns
t _{WP}	Write Cycle Time				10	ms

Note 1: Stress above those listed under "Absolute Maximum Ratings" may cause permanent damage to the device. This is a stress rating only and functional operation of the device at these or any other conditions above those indicated in the operational sections of the specification is not implied. Exposure to absolute maximum rating conditions for extended periods may affect device reliability.

Note 2: The SK frequency specification for Commercial parts specifies a minimum SK clock period of 1 microsecond, therefore in an SK clock cycle t_{SKH} + t_{SKL} must be greater than or equal to 1 microsecond. For example if t_{SKL} = 250 ns then the minimum t_{SKH} = 750 ns in order to meet the SK frequency specification.

Note 3: The SK frequency specification for Extended Temperature and Military parts specifies a minimum SK clock period of 2 microseconds, therefore in an SK clock cycle t_{SKH} + t_{SKL} must be greater than or equal to 2 microseconds. For example, if t_{SKL} = 500 ns then the minimum t_{SKH} = 1.5 microseconds in order to meet the SK frequency specification.

Note 4: For Commercial parts CS must be brought low for a minimum of 250 ns (t_{CS}) between consecutive instruction cycles.

Note 5: For Extended Temperature and Military parts CS must be brought low for a minimum of 500 ns (t_{CS}) between consecutive instruction cycles.

Note 6: This parameter is periodically sampled and not 100% tested.

Capacitance (Note 6)
T_A = 25°C, f = 1MHz

Symbol	Test	Typ	Max	Units
C _{OUT}	Output Capacitance		5	pF
C _{IN}	Input Capacitance		5	pF

AC Test Conditions

Output Load 1 TTL Gate and C_L = 100 pF

Input Pulse Levels 0.4V to 2.4V

Timing Measurement Reference Level

Input 1V and 2V

Output 0.8V and 2V

Functional Description

The NMC93CS56 and NMC93CS66 have 10 instructions as described below. Note that the MSB of any instruction is a "1" and is viewed as a start bit in the interface sequence. The next 10-bits carry the op code and the 8-bit address for register selection.

Read (READ):

The Read (READ) instruction outputs serial data on the DO pin. After a READ instruction is received, the instruction and address are decoded, followed by data transfer from the selected memory register into a 16-bit serial-out shift register. A dummy bit (logical 0) precedes the 16-bit data output string. Output data changes are initiated by a low to high transition of the SK clock. In the NONVOLATILE SHIFT-REGISTER mode of operation, the memory automatically cycles to the next register after each 16 data bits are clocked out. The dummy-bit is suppressed in this mode and a continuous string of data is obtained.

Write Enable (WEN):

When V_{CC} is applied to the part, it powers up in the Write Disable (WDS) state. Therefore, all programming modes must be preceded by a Write Enable (WEN) instruction. Once a Write Enable Instruction is executed programming remains enabled until a Write Disable (WDS) instruction is executed or V_{CC} is removed from the part.

Write (WRITE):

The Write (WRITE) instruction is followed by 16 bits of data to be written into the specified address. After the last bit of data is put on the data-in (DI) pin, CS must be brought low before the next rising edge of the SK clock. This falling edge of CS initiates the self-timed programming cycle. The PE pin MUST be held "high" while loading the WRITE instruction, however, after loading the WRITE instruction the PE pin becomes a "don't care". The DO pin indicates the READY/BUSY status of the chip if CS is brought high after a mini-

mum of 250 ns (t_{CS}). DO = logical 0 indicates that programming is still in progress. DO = logical 1 indicates that the register at the address specified in the instruction has been written with the data pattern specified in the instruction and the part is ready for another instruction.

Write All (WRALL):

The Write All (WRALL) instruction is valid only when the "protect register" has been cleared by executing a PRCLEAR instruction. The WRALL instruction will simultaneously program all registers with the data pattern specified in the instruction. Like the WRITE instruction, the PE pin MUST be held "high" while loading the WRALL instruction, however, after loading the WRITE instruction the PE pin becomes a "don't care". As in the WRITE mode, the DO pin indicates the READY/BUSY status of the chip if CS is brought high after a minimum of 250 ns (t_{CS}).

Write Disable (WDS):

To protect against accidental data disturb, the Write Disable (WDS) instruction disables all programming modes and should follow all programming operations. Execution of a READ instruction is independent of both the WEN and WDS instructions.

Protect Register Read (PRREAD):

The Protect Register Read (PRREAD) instruction outputs the address stored in the "protect register" on the DO pin. The PRE pin MUST be held "high" while loading the instruction. Following the PRREAD instruction the 8-bit address stored in the memory Protect Register is transferred to the serial out shift register. As in the READ mode, a dummy bit (logical 0) precedes the 8-bit address string.

Protect Register Enable (PREN):

The Protect Register Enable (PREN) instruction is used to enable the PRCLEAR, PRWRITE, and PRDS modes. Before

Instruction Set for the NMC93CS56 and NMC93CS66

Instruction	SB	Op Code	Address	Data	PRE	PE	Comments
READ	1	10	A7-A0		0	X	Reads data stored in memory, starting at specified address.
WEN	1	00	11XXXXXX		0	1	Write enable must precede all programming modes.
WRITE	1	01	A7-A0	D15-D0	0	1	Writes register if address is unprotected.
WRALL	1	00	01XXXXXX	D15-D0	0	1	Writes all registers. Valid only when Protect Register is cleared.
WDS	1	00	00XXXXXX		0	X	Disables all programming instructions.
PRREAD	1	10	XXXXXXXX		1	X	Reads address stored in Protect Register.
PREN	1	00	11XXXXXX		1	1	Must immediately precede PRCLEAR, PRWRITE, and PRDS instructions.
PRCLEAR	1	11	11111111		1	1	Clears the "protect register" so that no registers are protected from WRITE.
PRWRITE	1	01	A7-A0		1	1	Programs address into Protect Register. Thereafter, memory addresses ≥ the address in Protect Register are protected from WRITE.
PRDS	1	00	00000000		1	1	One time only instruction after which the address in the Protect Register cannot be altered.



Functional Description (Continued)

the PREN mode can be entered, the part must be in the Write Enable (WEN) mode. Both the PRE and PE pins **MUST** be held "high" while loading the instruction.

Note that a PREN instruction must **immediately** precede a PRCLEAR, PRWRITE, or PRDS instruction.

Protect Register Clear (PRCLEAR):

The Protect Register Clear (PRCLEAR) instruction clears the address stored in the Protect Register and, therefore, enables all registers for the WRITE and WRALL instruction. The PRE and PE pins must be held "high" while loading the instruction, however, after loading the PRCLEAR instruction the PRE and PE pins become "don't care". Note that a PREN instruction must **immediately** precede a PRCLEAR instruction.

Protect Register Write (PRWRITE):

The Protect Register Write (PRWRITE) instruction is used to write into the Protect Register the address of the first register to be protected. After the PRWRITE instruction is executed, all memory registers whose addresses are greater

than or equal to the address specified in the Protect Register are protected from the WRITE operation. Note that before executing a PRWRITE instruction the Protect Register must first be cleared by executing a PRCLEAR operation and that the PRE and PE pins must be held "high" while loading the instruction, however, after loading the PRWRITE instruction the PRE and PE pins become 'don't care'. Note that a PREN instruction must **immediately** precede a PRWRITE instruction.

Protect Register Disable (PRDS):

The Protect Register Disable (PRDS) instruction is a **one time only** instruction which renders the Protect Register unalterable in the future. Therefore, the specified registers become **PERMANENTLY** protected against data changes. As in the PRWRITE instruction the PRE and PE pins must be held "high" while loading the instruction, and after loading the PRDS instruction the PRE and PE pins become "don't care".

Note that a PREN instruction must **immediately** precede a PRDS instruction.

Timing Diagrams

Synchronous Data Timing

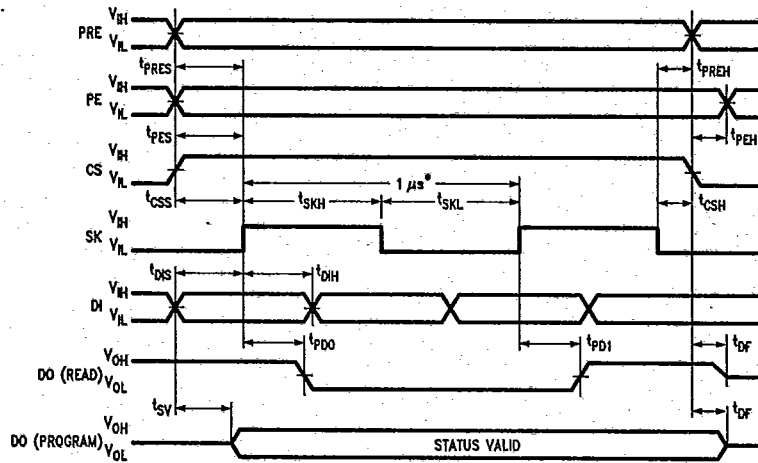

*This is the minimum SK period (See Note 2).

TL/D/9209-4

NMC93CS56/NMC93CS66

Timing Diagrams (Continued)

T-46-13-27

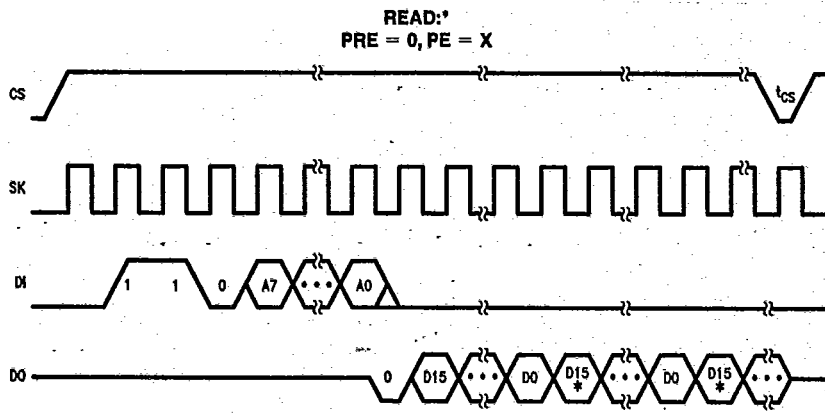

TL/D/8208-5

*Address bit A₇ becomes a "don't care" for NMC93CS56.

*The memory automatically cycles to the next register.

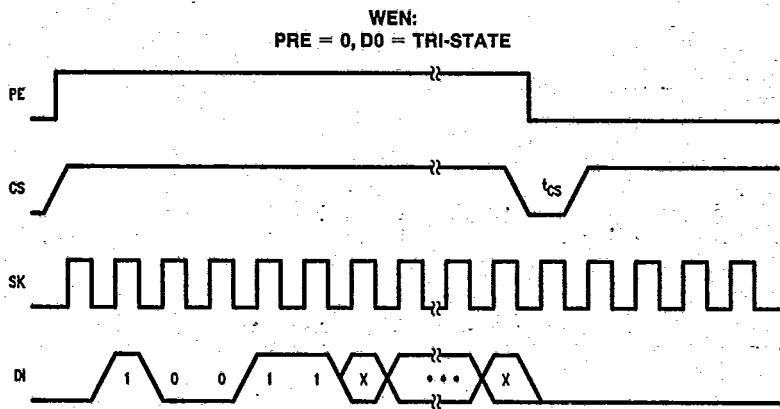

TL/D/8208-6

2

NMC93CS56/NMC93CS66

Timing Diagrams (Continued)

T-46-13-27

WDS:
PRE = 0, PE = X, DO = TRI-STATE

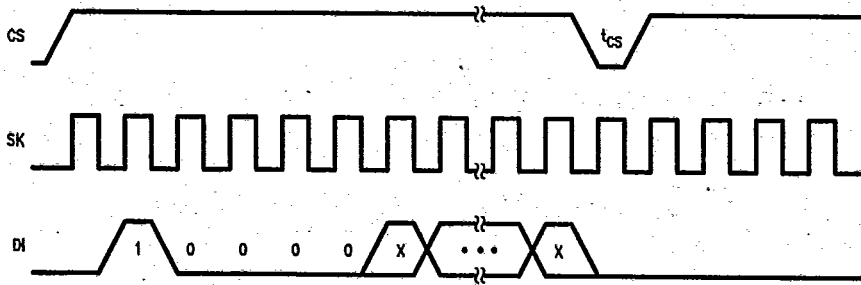

TL/D/9209-7

WRITE:*
PRE = 0

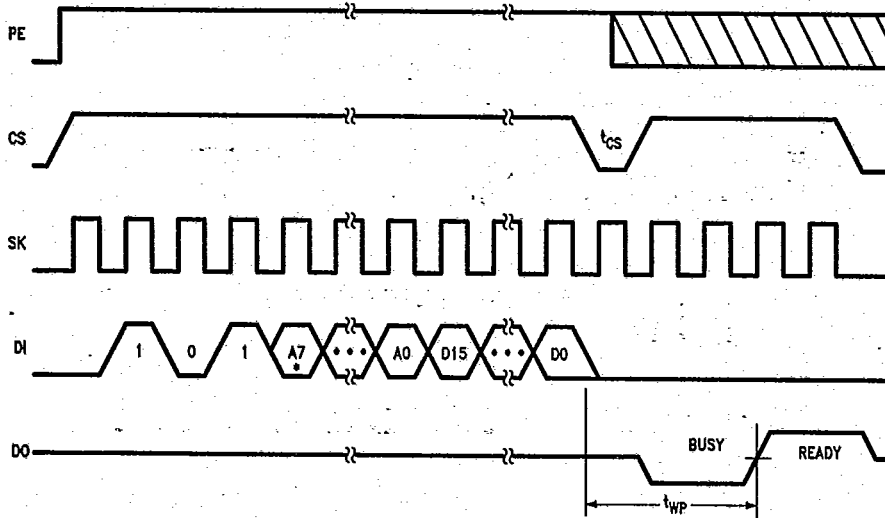

TL/D/9209-8

*Address bit A7 becomes a "don't care" for NMC93CS56.

Timing Diagrams (Continued)

T-46-13-27

NMC93CS56/NMC93CS66

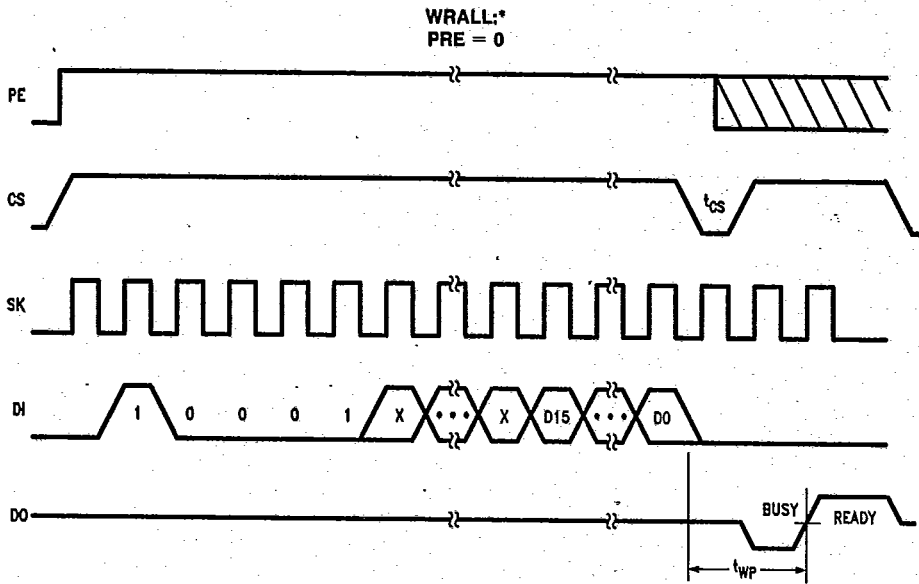

*Protect Register MUST be cleared.

TL/D/9209-9

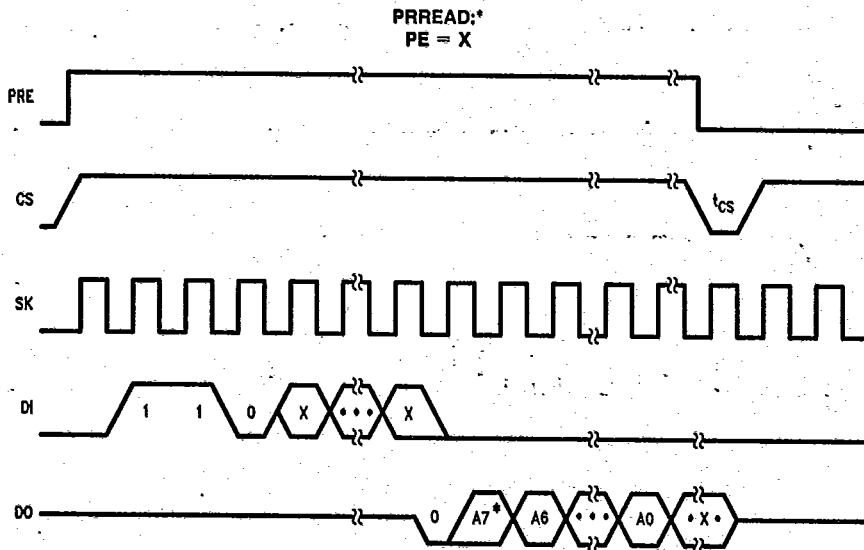

*Address bit A7 becomes a "don't care" for NMC93CS56.

TL/D/9208-10



NMC93CS56/NMC93CS66

Timing Diagrams (Continued)

T-46-13-27

PREN:*
DO = TRI-STATE

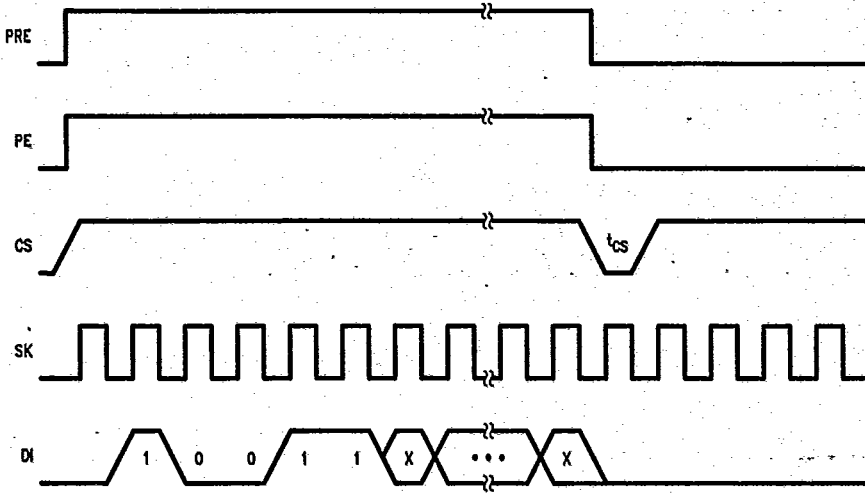

TL/D/9209-11

*A WEN cycle must precede a PREN cycle.

PRCLEAR:*

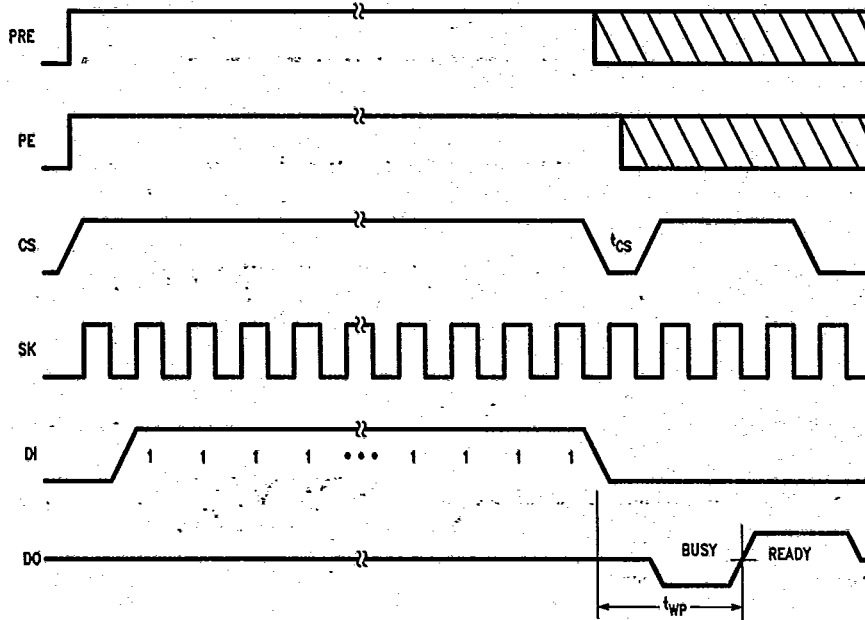

TL/D/9209-12

*A PREN cycle must immediately precede a PRCLEAR cycle.

Timing Diagrams (Continued)

T-46-13-27

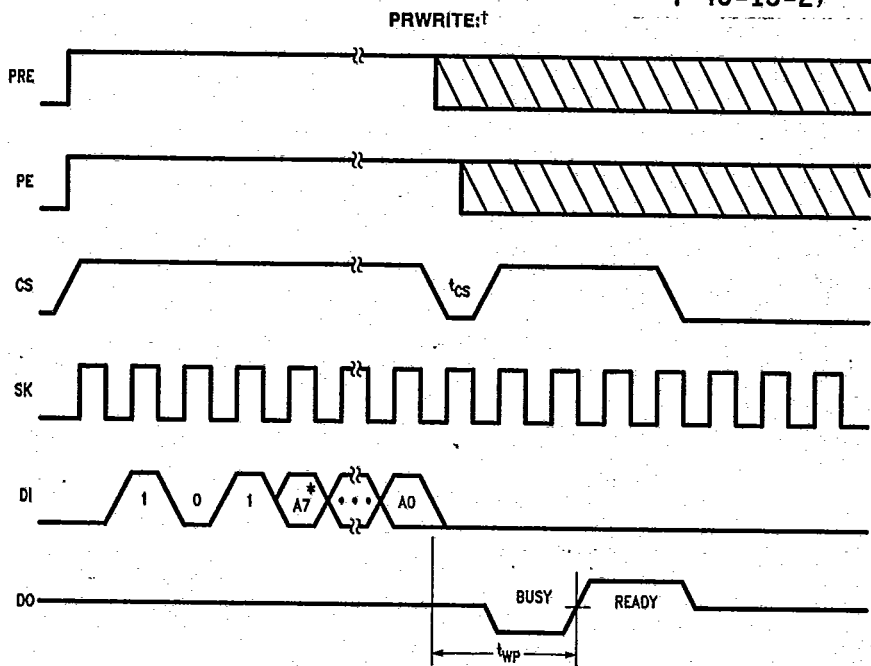

*Address bit A7 becomes a "don't care" for NMC93CS56.

†Protect Register MUST be cleared before a PRWRITE cycle. A PREN cycle must immediately precede a PRWRITE cycle.

TL/D/9209-13

PRDS:*

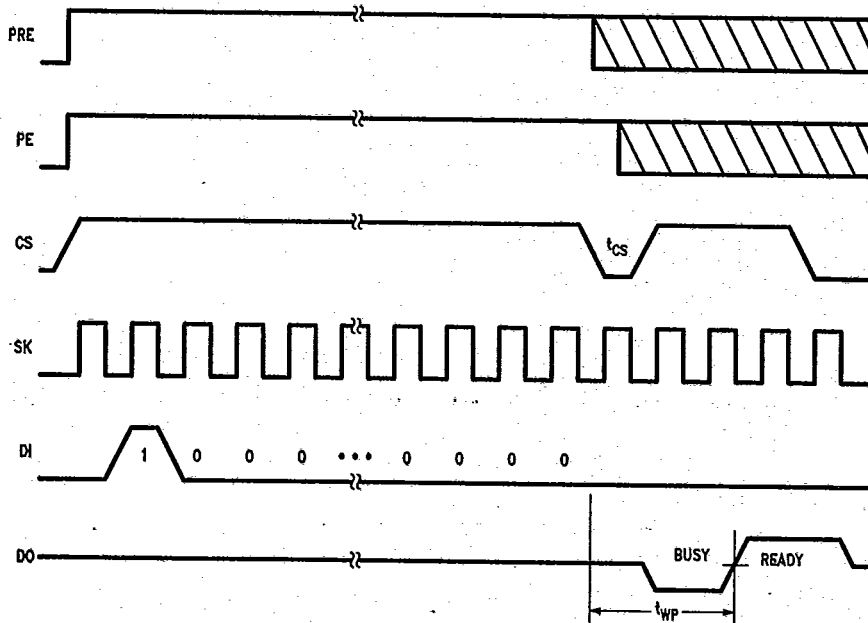

*ONE TIME ONLY instruction. A PREN cycle must immediately precede a PRDS cycle.

TL/D/9209-14

