

■ FEATURES

- Low Dropout Voltage of 470mV at 300mA Output Current (3.0V Output Version).
- Guaranteed 300mA Output Current.
- Low Ground Current at 55 μ A.
- 2% Accuracy Output Voltage of 1.8V/ 2.0V /2.5V /2.7V/ 3.0V/ 3.3V/ 3.5V/ 3.7V/ 3.8V/ 5.0V/ 5.2V.
- Only needs 1 μ F Output Capacitor for Stability.
- Current and Thermal Limiting.

■ APPLICATIONS

- CD-ROM Drivers.
- LAN Cards.
- Microprocessor.
- RAM Module.
- Wireless Communication Systems.
- Battery Powered Systems.

■ DESCRIPTION

The AIC1734 is a 3-pin low dropout linear regulator. The superior characteristics of the AIC1734 include zero base current loss, very low dropout voltage, and 2% accuracy output voltage. Typical ground current remains approximately 55 μ A, for loading ranging from zero to maximum. Dropout voltage at 300mA output current is exceptionally low. Built-in output current limiting and thermal limiting provide maximal protection to the AIC1734 against fault conditions.

The AIC1734 is available in popular SOT-23, SOT-89 and TO-92 packages.

■ TYPICAL APPLICATION CIRCUIT

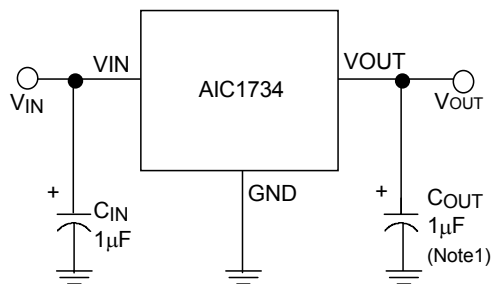

Low Dropout Linear Regulator

ORDERING INFORMATION

AIC1734-XXXXX XX

PACKING TYPE
TR: TAPE & REEL
BG: BAG

PACKAGE TYPE
U: SOT-23
XA: SOT-89
XT: SOT-89
ZT: TO-92
ZL: TO-92

C: Commercial
P: Lead Free Commercial
G: Green Package

OUTPUT VOLTAGE

18: 1.8V
20: 2.0V
25: 2.5V
27: 2.7V
30: 3.0V
33: 3.3V
35: 3.5V
37: 3.7V
38: 3.8V
50: 5.0V
52: 5.2V

- Example: AIC1734-18CXATR
→ 1.8V Version, in SOT-89 Package & Tape & Reel Packing Type
- AIC1734-18PXATR
→ 1.8V Version, in Lead Free SOT-89 Package & Tape & Reel Packing Type
- AIC1734-18GUTR
→ 1.8V Version, in Green SOT-23 Package & Reel Packing Type

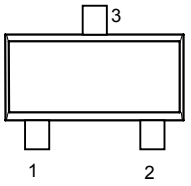
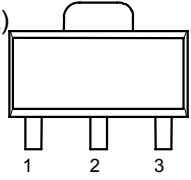
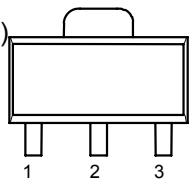
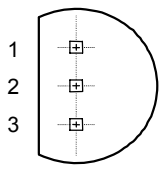
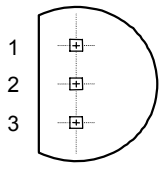
PIN CONFIGURATION	
SOT-23 (CU & PU) TOP VIEW 1: GND 2: VOUT 3: VIN	
SOT-89 (CXA & PXA) TOP VIEW 1: GND 2: VIN 3: VOUT	
SOT-89 (CXT & PXT) TOP VIEW 1: VOUT 2: GND 3: VIN	
TO-92 (CZT & PZT) TOP VIEW 1: GND 2: VIN 3: VOUT	
TO-92 (CZL & PZL) TOP VIEW 1: VIN 2: GND 3: VOUT	

SOT-23 MARKING

Part No.	CU	PU	GU	Part No.	CU	PU	GU
AIC1734-18XU	CD18	CD18P	CD18G	AIC1734-35XU	CD35	CD35P	CD35G
AIC1734-20XU	CD20	CD20P	CD20G	AIC1734-37XU	CD37	CD37P	CD37G
AIC1734-25XU	CD25	CD25P	CD25G	AIC1734-38XU	CD38	CD38P	CD38G
AIC1734-27XU	CD27	CD27P	CD27G	AIC1734-50XU	CD50	CD50P	CD50G
AIC1734-30XU	CD30	CD30P	CD30G	AIC1734-52XU	CD52	CD52P	CD52G
AIC1734-33XU	CD33	CD33P	CD33G				

● SOT-89 MARKING

Part No.	CXA	PXA	GXA	Part No.	CXT	PXT	GXT
AIC1734-18XXA	CA18	CA18P	CA18G	AIC1734-18XXT	CB18	CB18P	CB18G
AIC1734-20XXA	CA20	CA20P	CA20G	AIC1734-20XXT	CB20	CB20P	CB20G
AIC1734-25XXA	CA25	CA25P	CA25G	AIC1734-25XXT	CB25	CB25P	CB25G
AIC1734-27XXA	CA27	CA27P	CA27G	AIC1734-27XXT	CB27	CB27P	CB27G
AIC1734-30XXA	CA30	CA30P	CA30G	AIC1734-30XXT	CB30	CB30P	CB30G
AIC1734-33XXA	CA33	CA33P	CA33G	AIC1734-33XXT	CB33	CB33P	CB33G
AIC1734-35XXA	CA35	CA35P	CA35G	AIC1734-35XXT	CB35	CB35P	CB35G
AIC1734-37XXA	CA37	CA37P	CA37G	AIC1734-37XXT	CB37	CB37P	CB37G
AIC1734-38XXA	CA38	CA38P	CA38G	AIC1734-38XXT	CB38	CB38P	CB38G
AIC1734-50XXA	CA50	CA50P	CA50G	AIC1734-50XXT	CB50	CB50P	CB50G
AIC1734-52XXA	CA52	CA52P	CA52G	AIC1734-52XXT	CB52	CB52P	CB52G

■ ABSOLUTE MAXIMUM RATINGS

Input Supply Voltage.....	-0.3 ~12V
Operating Temperature Range	-40°C~ 85°C
Storage Temperature Range	-65°C~150°C
Maximum Junction Temperature.....	150°C
Lead Temperature (Soldering 10 sec.)	260°C
Thermal Resistance Junction to Case	SOT-89 Package..... 100°C/W
	TO-92 Package..... 120°C/W
	SOT-23 Package..... 130°C/W
Thermal Resistance Junction to Ambient	SOT-89 Package..... 160°C/W
(Assume no Ambient Airflow, no Heatsink)	TO-92 Package..... 150°C/W
	SOT-23 Package..... 180°C/W

Absolute Maximum Ratings are those values beyond which the life of a device may be impaired.

■ TEST CIRCUIT

Refer to the TYPICAL APPLICATION CIRCUIT

ELECTRICAL CHARACTERISTICS ($T_A=25^{\circ}\text{C}$, $C_{IN}=1\mu\text{F}$, $C_{OUT}=1\mu\text{F}$, unless otherwise specified.) (Note2)

PARAMETER	TEST CONDITIONS	MIN.	TYP.	MAX.	UNIT	
Output Voltage	No Load					
	AIC1734-52	$V_{IN}=5.5\sim 12\text{V}$	5.100	5.200	5.300	V
	AIC1734-50	$V_{IN}=5.5\sim 12\text{V}$	4.900	5.000	5.100	
	AIC1734-38	$V_{IN}=4.1\sim 12\text{V}$	3.725	3.800	3.875	
	AIC1734-37	$V_{IN}=4.0\sim 12\text{V}$	3.625	3.700	3.775	
	AIC1734-35	$V_{IN}=4.0\sim 12\text{V}$	3.430	3.500	3.570	
	AIC1734-33	$V_{IN}=4.0\sim 12\text{V}$	3.235	3.300	3.365	
	AIC1734-30	$V_{IN}=4.0\sim 12\text{V}$	2.940	3.000	3.060	
	AIC1734-27	$V_{IN}=4.0\sim 12\text{V}$	2.646	2.700	2.754	
	AIC1734-25	$V_{IN}=4.0\sim 12\text{V}$	2.450	2.500	2.550	
	AIC1734-20	$V_{IN}=4.0\sim 12\text{V}$	1.960	2.000	2.040	
AIC1734-18	$V_{IN}=4.0\sim 12\text{V}$	1.764	1.800	1.836		
Output Voltage Temperature Coefficiency	(Note 3)		50		PPM/ $^{\circ}\text{C}$	
Line Regulation	$I_L=1\text{mA}$, $1.4\text{V}\leq V_{OUT}\leq 3.2\text{V}$	$V_{IN}=4\text{V}\sim 12\text{V}$		3	10	mV
	$3.3\text{V}\leq V_{OUT}\leq 5.2\text{V}$	$V_{IN}=5.5\text{V}\sim 12\text{V}$		3	10	
Load Regulation (Note 4)	$I_L=0.1\sim 300\text{mA}$, $1.4\text{V}\leq V_{OUT}\leq 3.9\text{V}$	$V_{IN}=5\text{V}$		7	20	mV
	$4.0\text{V}\leq V_{OUT}\leq 5.2\text{V}$	$V_{IN}=7\text{V}$		15	40	
Current Limit (Note 5)	$V_{IN}=7\text{V}$, $V_{OUT}=0\text{V}$		300		mA	
Dropout Voltage (Note 6)	$I_L=300\text{mA}$	$4.0\text{V}\leq V_{OUT}\leq 5.2\text{V}$		400	500	mV
		$3.0\text{V}\leq V_{OUT}\leq 3.9\text{V}$		470	570	
		$2.5\text{V}\leq V_{OUT}\leq 2.9\text{V}$		570	670	
		$2.0\text{V}\leq V_{OUT}\leq 2.4\text{V}$		800	900	
		$1.4\text{V}\leq V_{OUT}\leq 1.9\text{V}$		1260	1360	
Ground Current	$I_O=0.1\text{mA}\sim I_{MAX}$, $1.4\text{V}\leq V_{OUT}\leq 3.9\text{V}$	$V_{IN}=5\sim 12\text{V}$		55	80	μA
	$4.0\text{V}\leq V_{OUT}\leq 5.2\text{V}$	$V_{IN}=7\sim 12\text{V}$		55	80	

Note 1: To avoid output oscillation, aluminum electrolytic output capacitor is recommended and ceramic capacitor is not suggested.

Note 2: Specifications are production tested at $T_A=25^{\circ}\text{C}$. Specifications over the -40°C to 85°C operating temperature range are assured by design, characterization and correlation with Statistical Quality Controls (SQC).

Note 3: Guaranteed by design.

Note 4: Regulation is measured at constant junction temperature, using pulse testing with a low ON time.

Note 5: Current limit is measured by pulsing a short time.

Note 6: Dropout voltage is defined as the input to output differential at which the output voltage drops 100mV.

TYPICAL PERFORMANCE CHARACTERISTICS

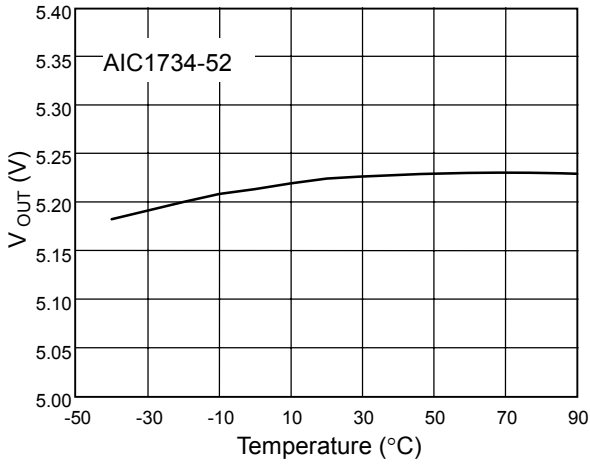

Fig. 1 V_{OUT} vs. Temperature

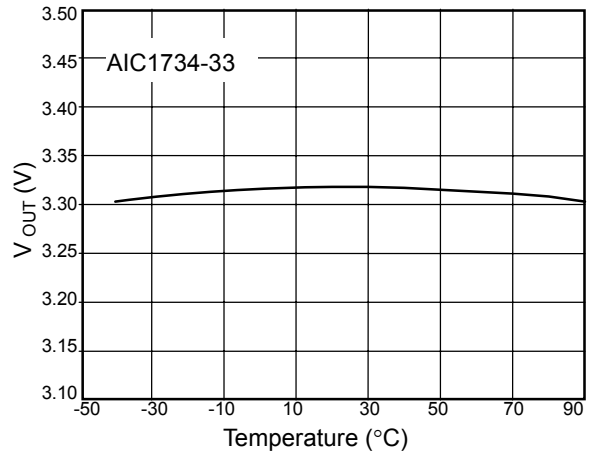

Fig. 2 V_{OUT} vs. Temperature

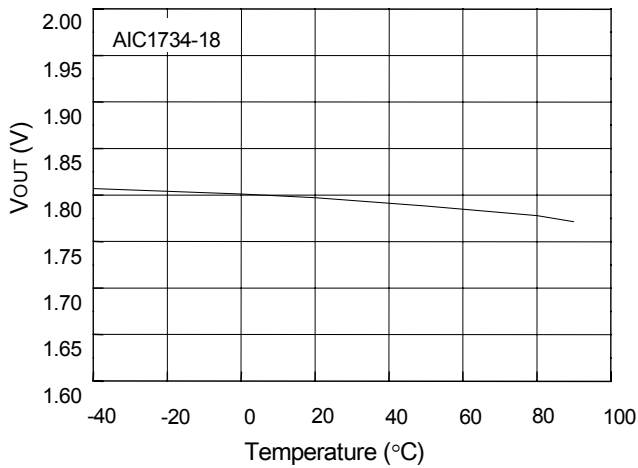

Fig. 3 V_{OUT} vs. Temperature

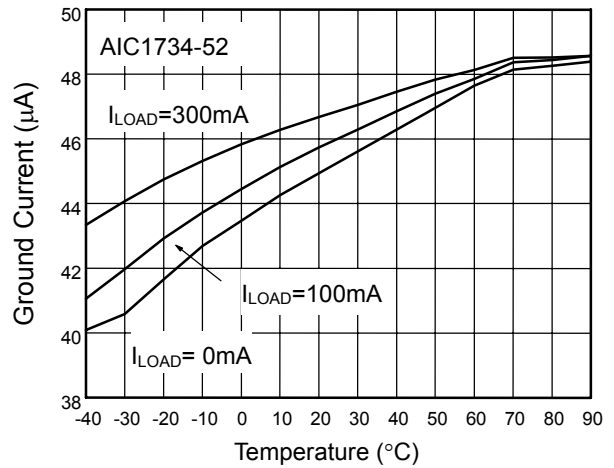

Fig. 4 Ground Current vs. Temperature

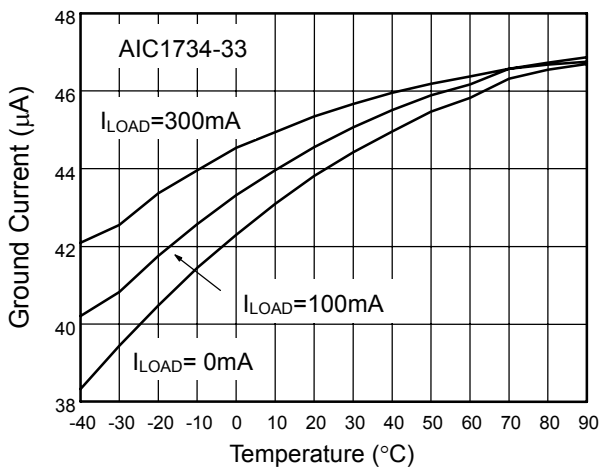

Fig. 5 Ground Current vs. Temperature

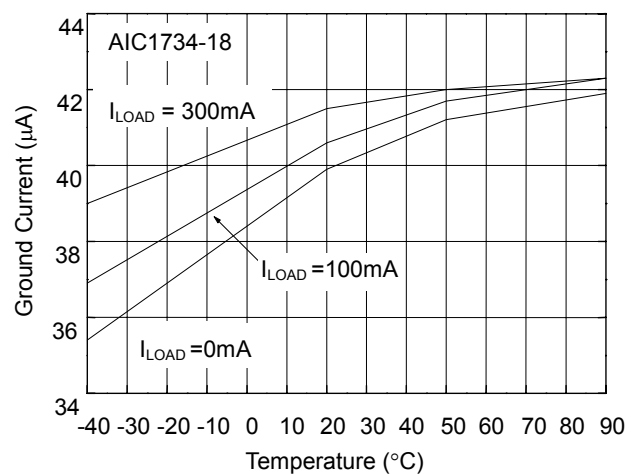

Fig. 6 Ground Current vs. Temperature

■ **TYPICAL PERFORMANCE CHARACTERISTIC (Continued)**

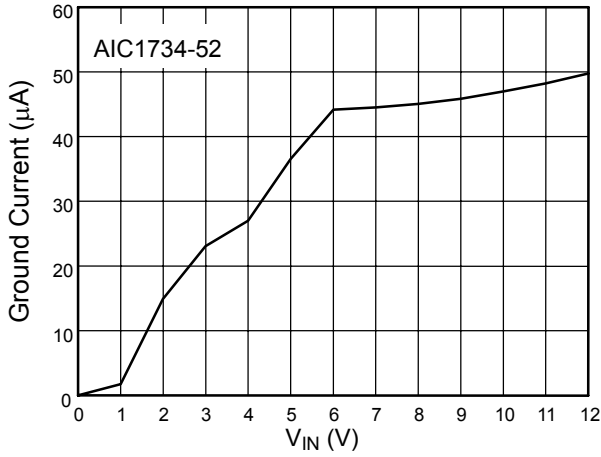

Fig. 7 Ground Current vs. V_{IN}

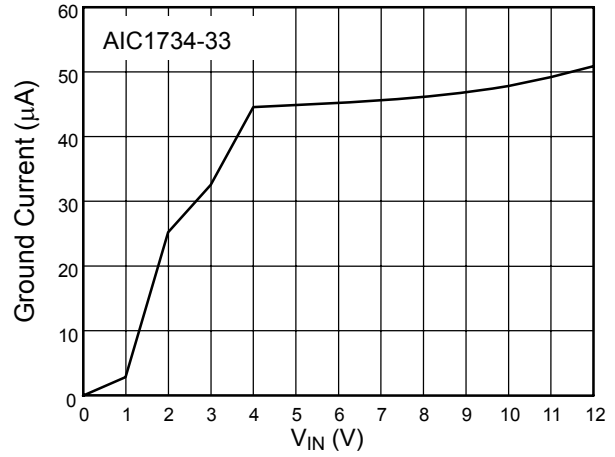

Fig. 8 Ground Current vs. V_{IN}

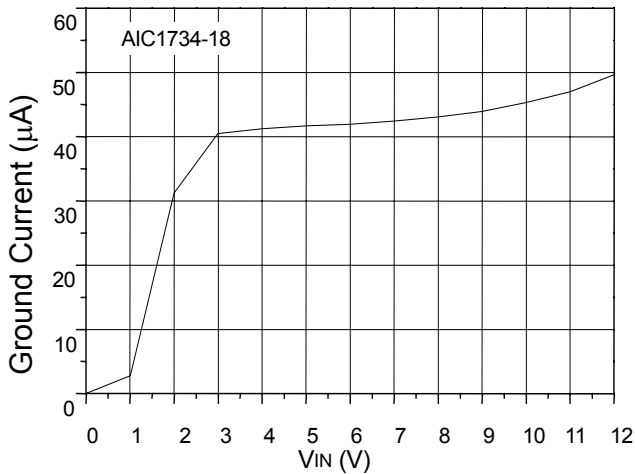

Fig. 9 Ground Current vs. V_{IN}

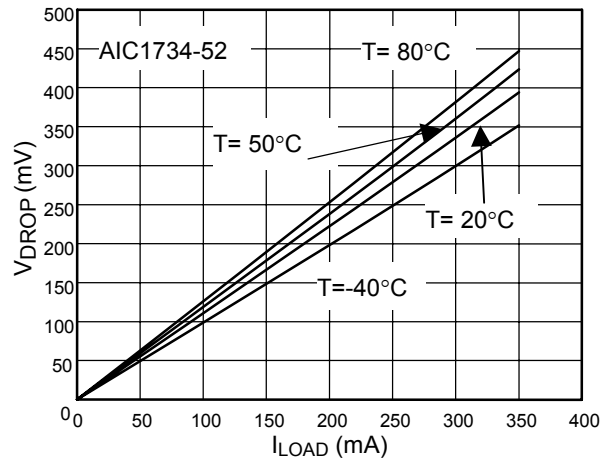

Fig. 10 V_{DROP} vs. I_{LOAD}

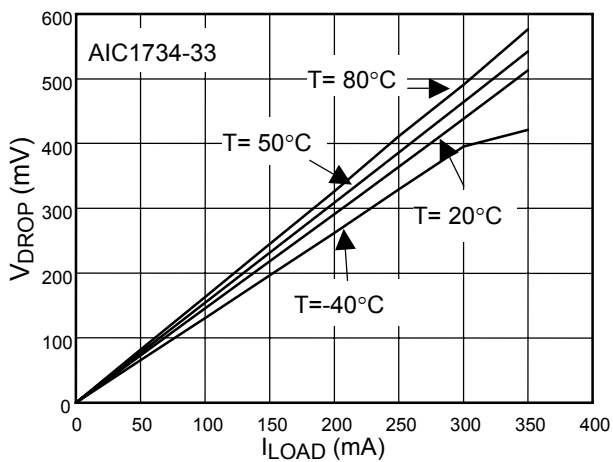

Fig. 11 V_{DROP} vs. I_{LOAD}

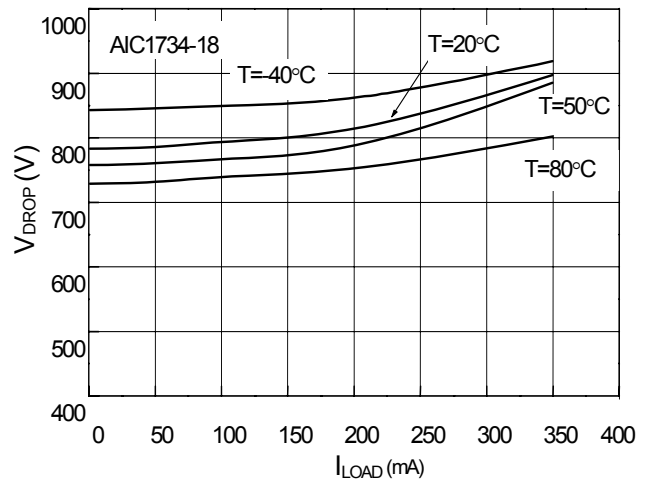

Fig. 12 V_{DROP} vs. I_{LOAD}

■ TYPICAL PERFORMANCE CHARACTERISTIC (Continued)

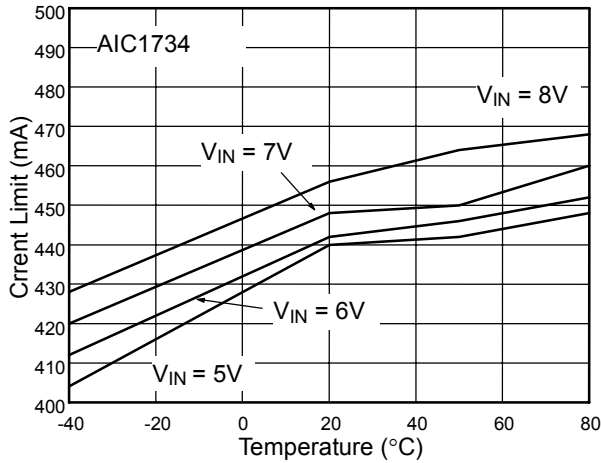

Fig. 13 Current Limit vs. Temperature

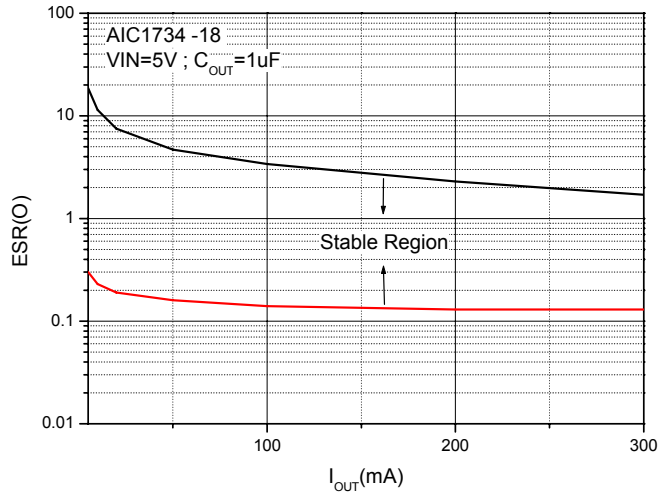

Fig. 14 Region of Stable C_{OUT} ESR vs. Load Current

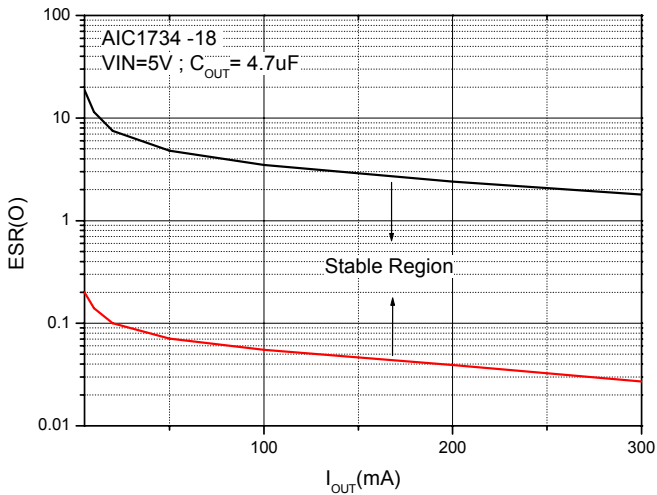

Fig. 15 Region of Stable C_{OUT} ESR vs. Load Current

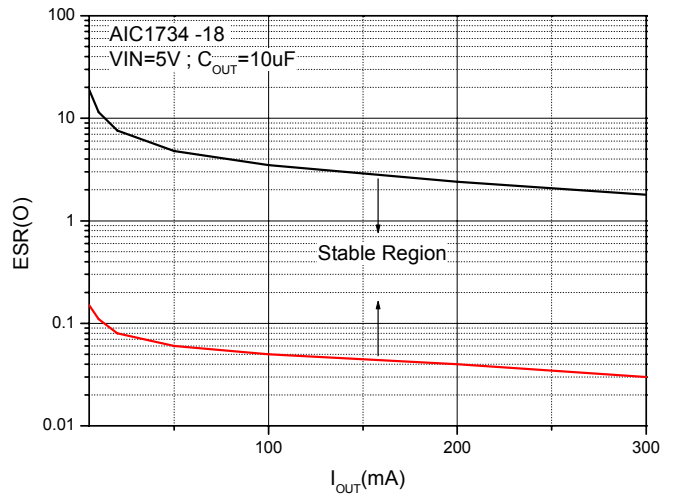
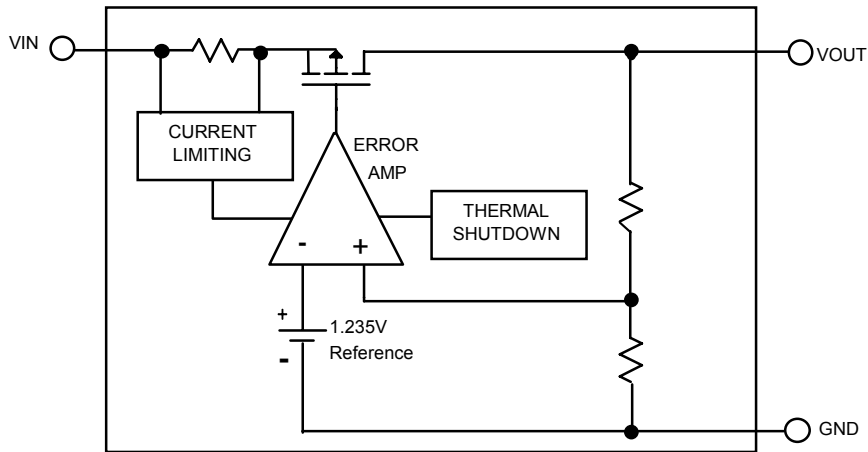

Fig. 16 Region of Stable C_{OUT} ESR vs. Load Current

■ BLOCK DIAGRAM



■ PIN DESCRIPTIONS

- VOUT PIN - Output pin.
- GND PIN - Power GND.
- VIN PIN - Power Supply Input.

■ APPLICATION INFORMATION

INPUT-OUTPUT CAPACITORS

Linear regulators require input and output capacitors to maintain stability. A 1uF aluminum electrolytic input capacitor with a 1uF aluminum electrolytic output capacitor is recommended. To avoid oscillation, it is recommended to follow the figures of “Region of Stable C_{OUT} ESR vs. Load Current” to choose proper capacitor specifications.

POWER DISSIPATION

The AIC1734 obtains thermal-limiting circuitry, which is designed to protect the device against overload condition. For continuous load condition, maximum rating of junction temperature must not be exceeded. It is important to pay more attention in thermal resistance. It includes junction to case, junction to ambient. The maximum power dissipation of AIC1734 depends on the thermal resistance of its case and circuit board, the temperature difference between the die junction and ambient air, and the rate of airflow. The rate of temperature rise is greatly affected by the mounting pad configuration on the PCB, the

board material, and the ambient temperature. When the IC mounting with good thermal conductivity is used, the junction temperature will be low even when large power dissipation applies.

The power dissipation across the device is

$$P = I_{OUT} (V_{IN} - V_{OUT}).$$

The maximum power dissipation is:

$$P_{MAX} = \frac{(T_{J-max} - T_A)}{R\theta_{JA}}$$

Where T_{J-max} is the maximum allowable junction temperature (125°C), and T_A is the ambient temperature suitable in application.

As a general rule, the lower temperature is, the better reliability of the device is. So the PCB mounting pad should provide maximum thermal conductivity to maintain low device temperature. GND pin performs a dual function for providing an electrical connection to ground and channeling heat away. Therefore, connecting the GND pin to ground with a large pad or ground plane would increase the power dissipation and reduce the device temperature.

■ PHYSICAL DIMENSIONS (unit: mm)

● SOT-23

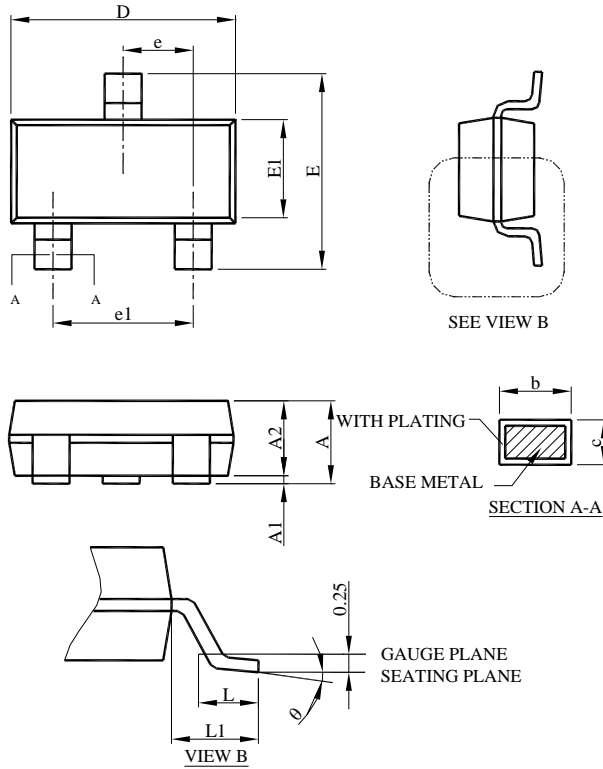

SYMBOL	SOT-23	
	MILLIMETERS	
	MIN.	MAX.
A	0.95	1.45
A1	0.05	0.15
A2	0.90	1.30
b	0.30	0.50
c	0.08	0.22
D	2.80	3.00
E	2.60	3.00
E1	1.50	1.70
e	0.95 BSC	
e1	1.90 BSC	
L	0.30	0.60
L1	0.60 REF	
θ	0°	8°

- Note:
- 1.Refer to JEDEC MO-178.
 - 2.Dimension D and E1 do not include mold flash, protrusions or gate burrs. Mold flash, protrusion or gate burrs shall not exceed 10 mil per side.
 - 3.Controlling dimension is millimeter, converted inch dimensions are not necessarily exact.

● SOT-89

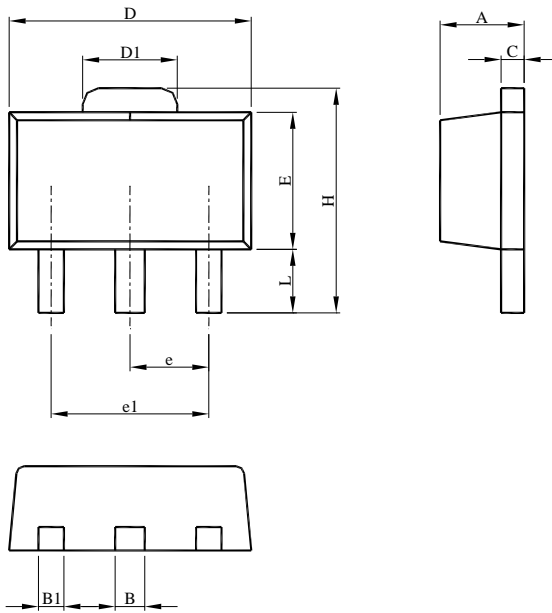

SOT-89		
MILLIMETERS		
SYMBOL	MIN.	MAX.
A	1.40	1.60
B	0.44	0.56
B1	0.36	0.48
C	0.35	0.44
D	4.40	4.60
D1	1.50	1.83
E	2.29	2.60
e	1.50 BSC	
e1	3.00 BSC	
H	3.94	4.25
L	0.89	1.20

Note:
 1.Refer to JEDEC TO-243AA.
 2.Controlling dimension is millimeter, converted inch dimensions are not necessarily exact.

● TO-92 (BAG)

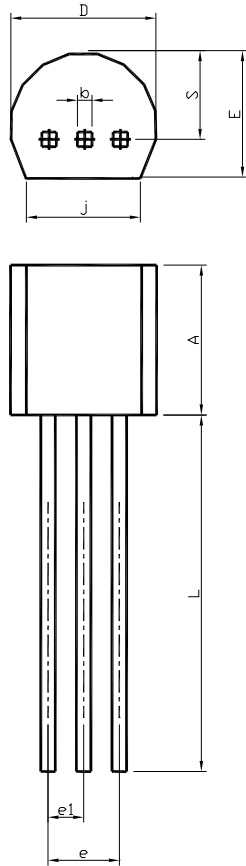

SYMBOL	TO-92	
	MILLIMETERS	
	MIN.	MAX.
A	4.32	5.33
b	0.36	0.47
D	4.45	5.20
E	3.18	4.19
e	2.42	2.66
e1	1.15	1.39
j	3.43	
L	12.70	
S	2.03	2.66

Note:
 1.Refer to JEDEC TO-92.
 2.Controlling dimension is millimeter, converted inch dimensions are not necessarily exact.

● TO-92 (Tape & Reel)

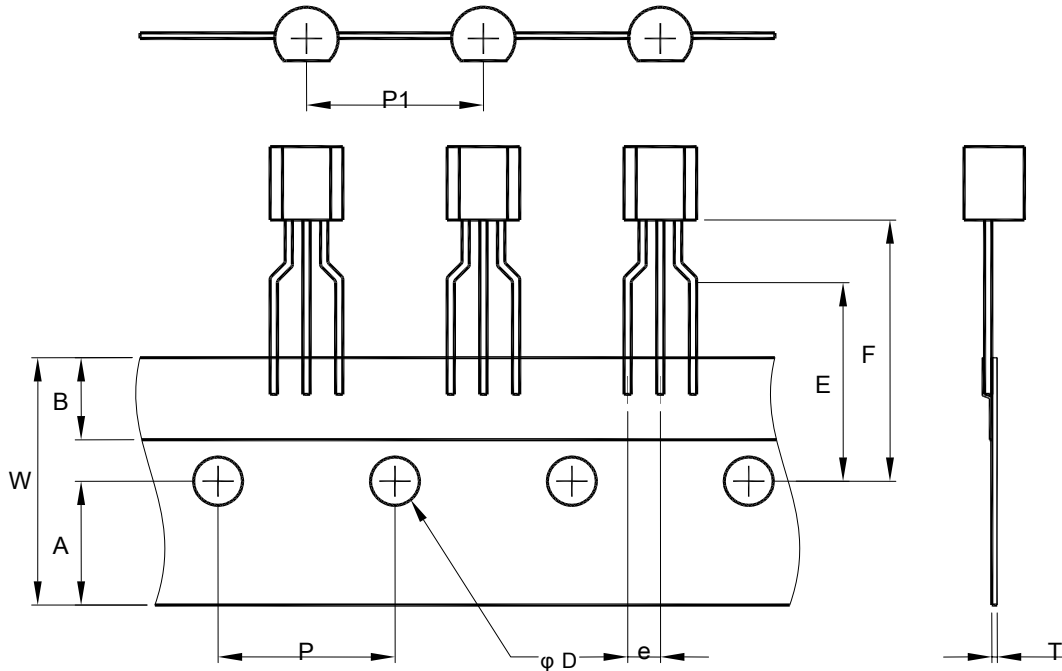

SYMBOL	W	A	B	E	F
SPEC.	18.0± 0.2	9.0± 0.2	6.0± 0.20	16.0± 0.5	19.0± 0.5
SYMBOL	P	P1	D	e	T
SPEC.	12.7 BSC	12.7 BSC	4.0± 0.2	2.5 BSC	0.6± 0.1

Note:

Information provided by AIC is believed to be accurate and reliable. However, we cannot assume responsibility for use of any circuitry other than circuitry entirely embodied in an AIC product; nor for any infringement of patents or other rights of third parties that may result from its use. We reserve the right to change the circuitry and specifications without notice.

Life Support Policy: AIC does not authorize any AIC product for use in life support devices and/or systems. Life support devices or systems are devices or systems which, (i) are intended for surgical implant into the body or (ii) support or sustain life, and whose failure to perform, when properly used in accordance with instructions for use provided in the labeling, can be reasonably expected to result in a significant injury to the user.